



# User Manual

for S6 Series Hybrid Inverter



## Applicable models

S6-EH3P12K-H  
S6-EH3P15K-H  
S6-EH3P20K-H  
S6-EH3P8K-LV-H  
S6-EH3P10K-LV-H  
S6-EH3P12K-LV-H

## Applicable System

Three phase system

<b>1. Introduction</b>	03
1.1 Product Description	03
1.2 Packaging	04
1.3 Inverter Circuit Diagram	05
1.4 Tools Required for Installation	05
<b>2. Safety &amp; Warning</b>	06
2.1 Safety	06
2.2 General Safety Instructions	06
2.3 Notice For Use	08
2.4 Notice for Disposal	08
<b>3. Overview</b>	09
3.1 HMI Screen	09
3.2 System Description	10
<b>4. Installation</b>	16
4.1 Select a Location for the Inverter	16
4.2 Mounting the Inverter	18
4.3 PE Cable Installation	19
4.4 PV Input Cable Installation	20
4.5 Battery Cable Installation	23
4.6 AC Wiring	24
4.7 CT Connection	25
4.8 Inverter Communication	26
4.9 Inverter Remote Monitoring Connection	33
<b>5. Commissioning &amp; Shutdown</b>	34
5.1 Preparation of Commissioning	34
5.2 Commissioning Procedure	34
5.3 Log in the APP via Bluetooth	35
5.4 Shutdown procedure	37
5.5 Work Mode and Settings	38
5.6 TOU Function Settings	43
5.7 Battery Settings	44
5.8 Battery Functions setting	45
5.9 Smart port settings	46
5.10 Grid port settings	49
5.11 Parallel Settings	50
5.12 Only PV power load function	50
5.13 HMI Screen Setting	52

# Contents

---

6. Maintenance .....	62
7. Troubleshooting .....	63
8. Specifications .....	68

## 1.1 Product Description

The Solis S6 Series is designed for residential hybrid systems, which can work with batteries to optimize self-consumption. The unit can operate in both off- and on-grid modes.

This manual covers the Solis S6 Series inverter model listed below:

S6-EH3P12K-H, S6-EH3P15K-H, S6-EH3P20K-H, S6-EH3P8K-LV-H,  
S6-EH3P10K-LV-H, S6-EH3P12K-LV-H

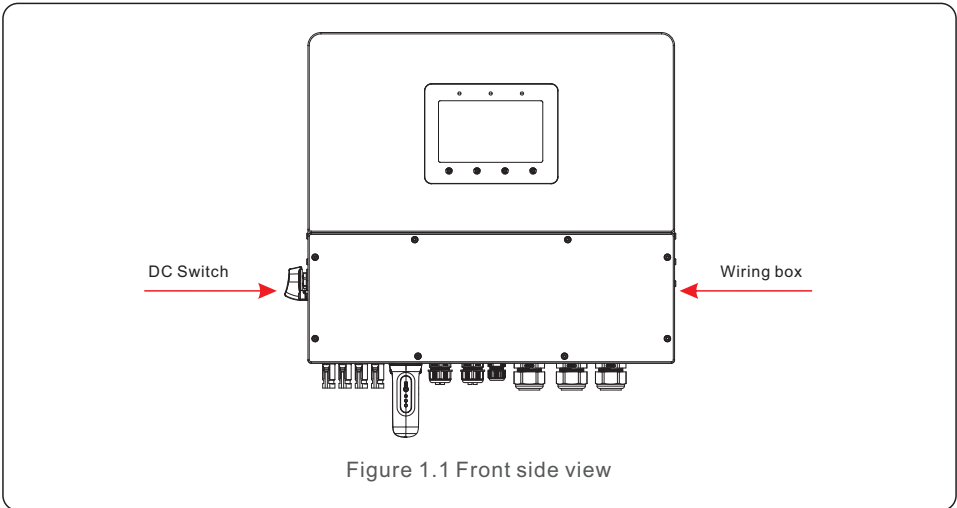

Figure 1.1 Front side view

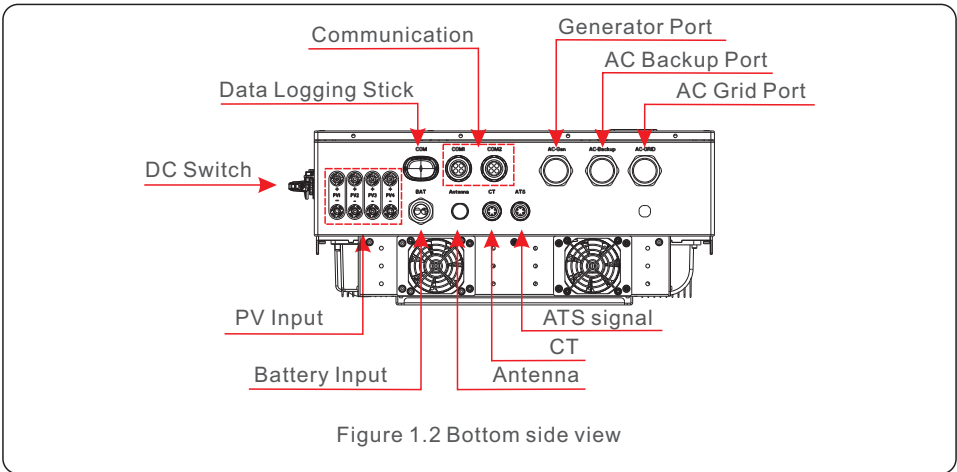
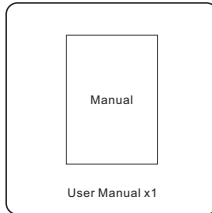
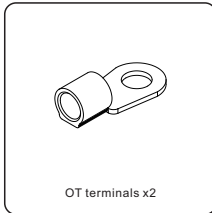
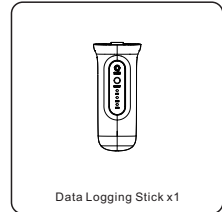
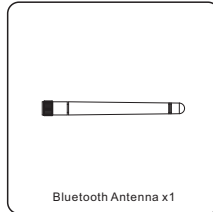
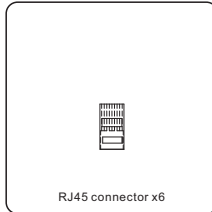
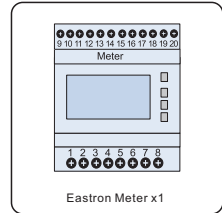
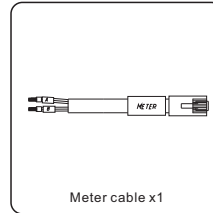
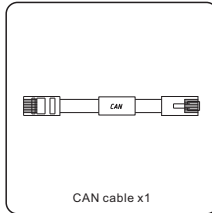
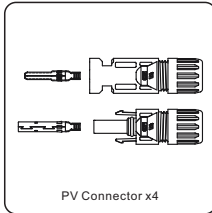
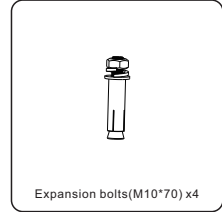
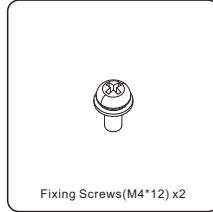
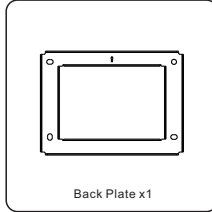
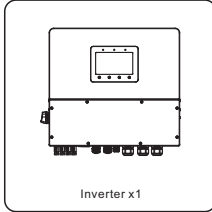

Figure 1.2 Bottom side view

## 1.2 Packaging

Please ensure that the following items are included in the packaging with your machine:



Manual

User Manual x1



### NOTE:

If customer purchases the CT configuration scheme, the attachment only contains CT.

If the meter configuration plan is purchased, the accessories include CT, the meter, and the meter communication cable.

If more than 4 devices are connected in parallel (more than 3 for the 20K model), select a separate kit. The accessories include CT and the meter.

If anything is missing, please contact your local Solis distributor.

## 1.3 Inverter Circuit Diagram

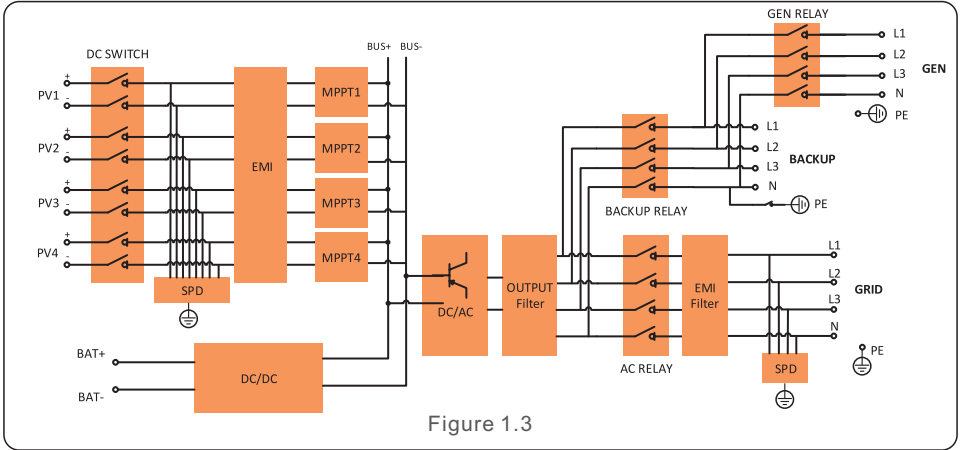

## 1.4 Tools Required for Installation



## 2.1 Safety

The following types of safety instructions and general information appear in this document as described below:



**DANGER:**

“Danger” indicates a hazardous situation which if not avoided, will result in death or serious injury.



**WARNING:**

“Warning” indicates a hazardous situation which if not avoided, could result in death or serious injury.



**CAUTION:**

“Caution” indicates a hazardous situation which if not avoided, could result in minor or moderate injury.



**NOTE:**

“Note” provides tips that are valuable for the optimal operation of your product.



**WARNING: Risk of fire**

Despite careful construction, electrical devices can cause fires.

- Do not install the inverter in areas containing highly flammable materials or gases.
- Do not install the inverter in potentially explosive atmospheres.

## 2.2 General Safety Instructions



**WARNING:**

Only devices in compliance with SELV (EN 69050) may be connected to the RS485 and USB interfaces.



**WARNING:**

Please don't connect PV array positive (+) or negative (-) to ground, it could cause serious damage to the inverter.



**WARNING:**

Electrical installations must be done in accordance with the local and national electrical safety standards.



**WARNING:**

Do not touch any inner live parts until 5 minutes after disconnection from the utility grid and the PV input.



**WARNING:**

To reduce the risk of fire, over-current protective devices (OCPD) are required for circuits connected to the inverter.

The DC OCPD shall be installed per local requirements. All photovoltaic source and output circuit conductors shall have isolators that comply with the NEC Article 690, Part II.



**CAUTION:**

Risk of electric shock, do not remove cover. There is no user serviceable parts inside, refer servicing to qualified and accredited service technicians.



**CAUTION:**

The PV array supplies a DC voltage when they are exposed to sunlight.



**CAUTION:**

The surface temperature of the inverter can reach up to 75°C (167°F). To avoid risk of burns, do not touch the surface of the inverter while it's operating. Inverter must be installed out of the reach of children.



**NOTE:**

PV module used with inverter must have an IEC 61730 Class A rating.



**WARNING:**

Operations below must be accomplished by licensed technician or Solis authorized person.



**WARNING:**

Operator must put on the technicians' gloves during the whole process in case of any electrical hazards.



**WARNING:**

AC BACKUP Port of S6 Series is not allowed to connect to the grid.



**WARNING:**

Please refer to the specification of the battery before configuration.



## 2.3 Notice for Use

The inverter has been constructed according to the applicable safety and technical guidelines. Use the inverter in installations that meet the following specifications ONLY:

1. Permanent installation is required.
2. The electrical installation must meet all the applicable regulations and standards.
3. The inverter must be installed according to the instructions stated in this manual.
4. The inverter must be installed according to the correct technical specifications.
5. The inverter contains an internal NEB that meets the requirements of NRS 097-2-1:2024 Section 5.4.

## 2.4 Notice for Disposal

This product shall not be disposed of with household waste. They should be segregated and brought to an appropriate collection point to enable recycling and avoid potential impacts on the environment and human health. Local rules in waste management shall be respected .

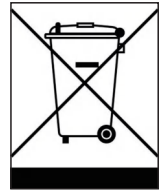

## 3.1 HMI Screen

There are 3 indicators and 4 operation button on the Solis S6 Series Inverter.

Three LED indicators on the hybrid inverter (Red, Green, and Orange) which indicate the working status of the inverter.



Light	Status	Description
● POWER	ON	The inverter can detect DC power.
	OFF	No DC power.
● OPERATION	ON	The inverter is fully operational.
	OFF	The inverter has stopped operating.
	FLASHING	The inverter is initializing.
● ALARM	ON	Emergency Fault.
	OFF	No fault condition detected.
	FLASHING	Warning and Normal Fault.

Table 3.1 Status Indicator Lights

Description of buttons:



Button	Description
ESC	“Escape”, allows the user to exit, or cancel the operation.
UP	Upwards key, allows the user to increase the value or move forward to the next option.
DOWN	Downwards key, allows the user to decrease the value or move backward to the previous option.
ENTER	Running or executing command .



**NOTE:** The screen will be automatically turn off after being idle for a few minutes to save power, click any operation button(“ESC”/“UP”/“DOWN”/ “ENTER”) to restart the screen, then press“Enter”into the main operation interface.

## 3.2 System Description

### 3.2.1 Single system

The single system consists of PV module, battery, hybrid inverter, CT or smart meter. The PV Module converts solar energy into electric energy, which is then converted by the inverter to charge the battery or power loads or feed into the grid.

User can connect heat pump, existing PV plant, generator and ATS according to the actual scenario.

The system has three working modes: self-use mode, feed in priority mode and off-grid mode.

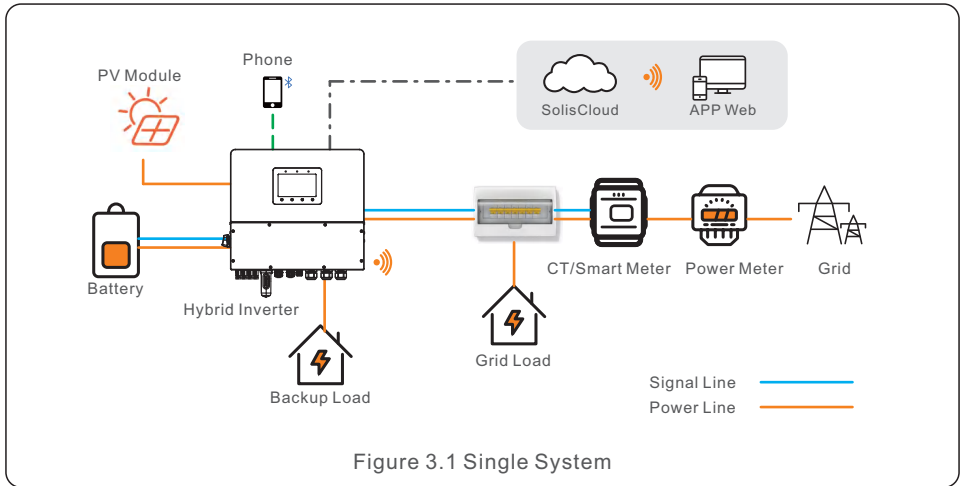

Figure 3.1 Single System



#### NOTE:

- If the CTs are connected, the Smart meter is not essential.
- you can choose CT scheme or Meter scheme deliver with inverter.
- In the event of a power outage on the grid, the system will seamlessly transition into off-grid mode, providing power exclusively to essential backup loads.
- When the grid recovers, the system switches back to the on-grid operation.
- Supports heat pump start-stop and power control, only when it has a SG Ready label.

## 3.2.2 Parallel System

User can add inverters and batteries to increase capacity. The system supports up to 6 inverters in parallel. Each battery connects to the inverter with an independent CAN line and is managed by the inverter connected to it.

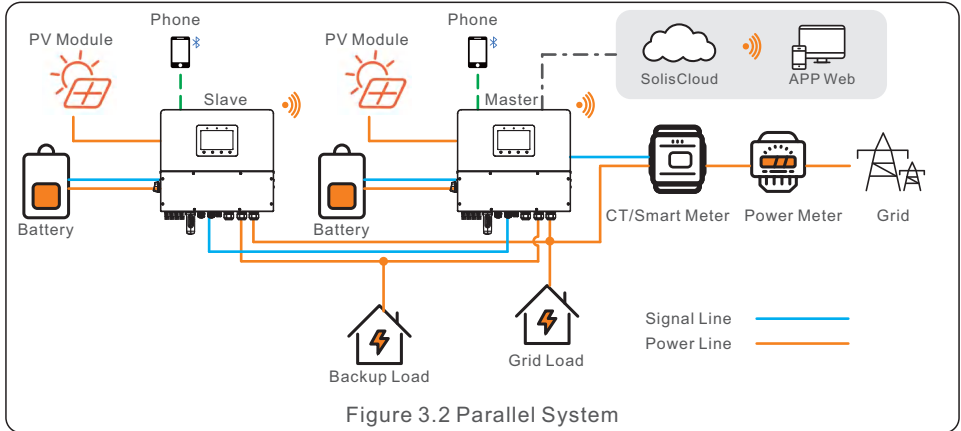

**NOTE:**

In parallel-system scenarios, maximum support 6 parallel connections. Parallel connection of different models is not supported. (Like 12K and 15K can't be connected in parallel).  
 The AC-Backup port can be connected in parallel, and the single-phase output power is 1 / 2 of the total AC power.  
 Parallel connection of BAT port is not supported.  
 In parallel-system scenarios, connecting DG via ATS is recommended;  
 In the parallel system, each inverter is recommended to plug in the datalogger, otherwise, the remote upgrade cannot be performed.  
 The parallel cable between the two inverters should not exceed 5m.



**NOTE:**

Single inverter noise is less than 65 dB (A), When using multiple inverters to combine, pay attention to noise protection.

Scenarios	12K	15K	20K	8K-LV	10K-LV	12K-LV	Backup single-phase output power (For example 12K)	Recommended Battery Capacity (For example, 12K&Backup 2h)
	AC capacity							
1 single	12K	15K	20K	8K	10K	12K	6K	24KWh
2 in parallel	24K	30K	40K	16K	20K	24K	12K	24KWh*2
3 in parallel	36K	45K	60K	24K	30K	36K	18K	24KWh*3
4 in parallel	48K	60K	80K	32K	40K	48K	24K	24KWh*4
5 in parallel	60K	75K	100K	40K	50K	60K	30K	24KWh*5
6 in parallel	72K	90K	120K	48K	60K	72K	36K	24KWh*6

### 3.2.3 System with generator

The access of Diesel Generator is in the off-grid scenario.

The system stores PV energy in batteries during daytime, provided that there is energy surplus and supplies power to loads when the PV energy is insufficient or there is no PV energy at night.

When the battery power drops to a certain value, and a power outage occurs in the grid, the system will start the generator to power the load and charge the battery.

Generator’s work logic is as follows:

**(i)**when the grid is not available and the battery is discharged to GEN\_Start\_SOC, the generator starts to power the load and charges the battery to GEN\_Exit\_SOC, then the generator stops.

**(ii)**If the load power > the generator rated power in (i), the battery will be discharged to power the load until Overdischarge\_SOC, then generator may shutdown due to overload and the load will be powered off.

**(iii)**If the generator fail to start in (i), the battery will be discharge to Overdischarge\_SOC, then the load power off.

**(iv)**If the system goes into the end of (iii), the battery will not discharge before it is charged to Overdischarge\_SOC+ Overdischarge\_Hysteresis\_SOC (set by user).

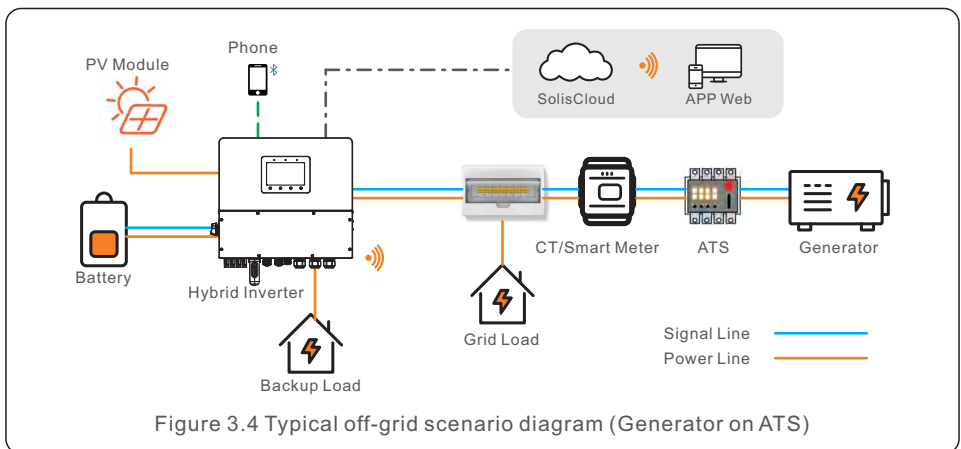
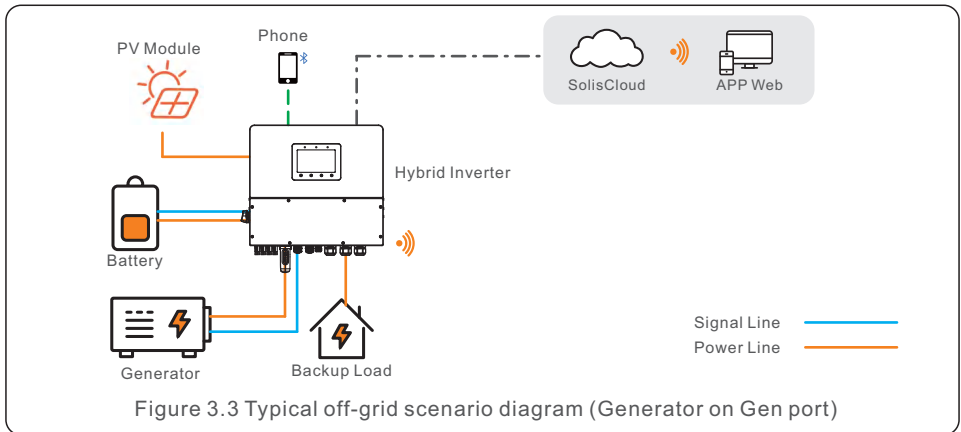

**NOTE:**

- In single system, a diesel generator can be connected via both AC-Gen port and ATS. If via AC-Gen port, it will only supply power to the backup load ; if it is necessary to supply power to the grid side, it is recommended that the generator be connected through ATS.
- In parallel-system scenarios, connecting a diesel generator via ATS is recommended.
- When the system is connected to the generator, it cannot be connected to a grid-tied inverter, because of a risk of damaging the generator.
- It is recommended that the generator power be greater than the backup load power.
- If the generator is connected through an ATS on the grid side(Figure 3.4), then CT or smart meter is required.



**CAUTION:**

When the generator is connected, it is essential to correctly select the generator position on the APP, otherwise it may cause system failure or damage to the generator.

### 3.2.4 System with grid-tied inverter

Generally, the access of grid-tied inverter is for the retrofit of an existing PV plant. The S6 hybrid inverter support access of both Solis grid-tied inverter and third-party grid-tied inverter.

#### 3.2.4.1 Access of third-party grid-tied inverter

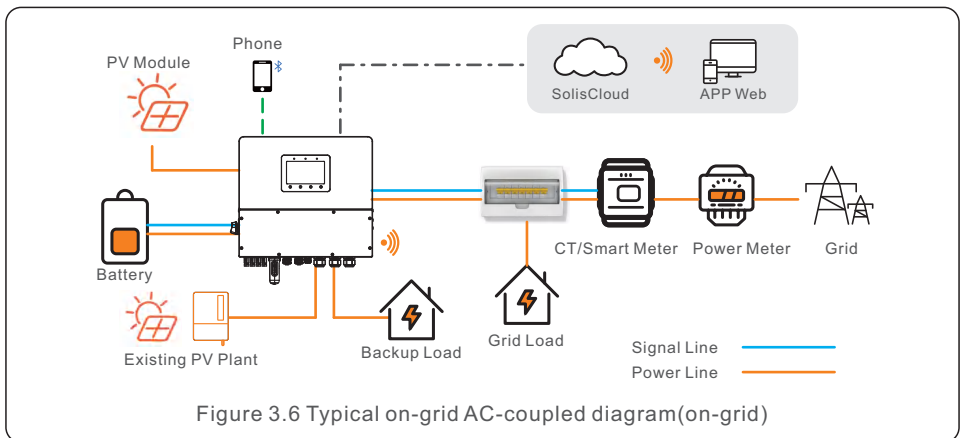
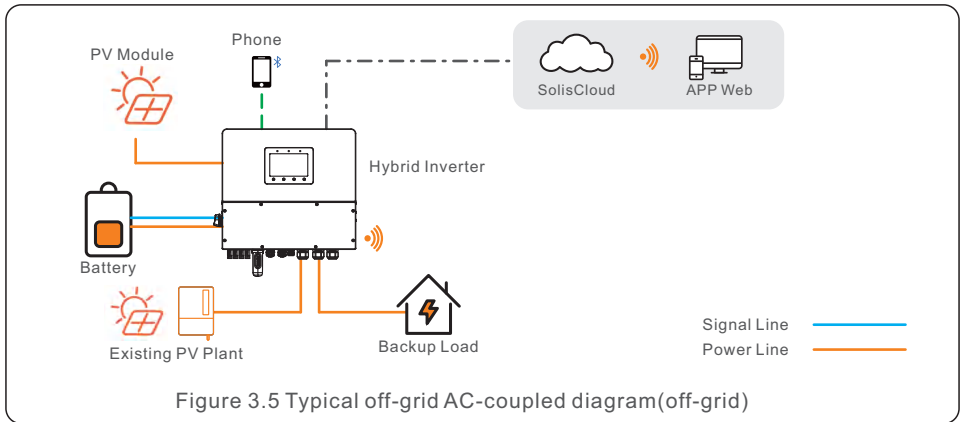

- Third-party grid-tied inverter can be connected via AC-Gen port.
- With third-party grid-tied inverter connected to the system, it is recommended that:  
Grid-tied inverter power < rated AC power of S6 inverter.
- In on-grid scenario, when the third-party grid-tied inverter is connected, the system cannot control the output power of the third-party grid-tied inverter, so Feed-in limitation cannot be realized.
- In off-grid scenario, the third-party grid-tied inverter must be configured with the correct grid code and equipped with over-frequency load shedding and under-frequency load rising functionalities. These features allow the system to dynamically adjust the frequency, effectively controlling the output power of the grid-tied inverter.

### 3.2.5 System with Smartload

The Gen port has extended power, which can be used as Smart load output.

You can use the smartload function to connect critical loads to the backup port and non-critical loads to the Gen port. This allows you to manage the power supply of different loads when off-grid.

When the battery SOC/Volt reach the ON set value, the smart port will supply power to the load. When the battery SOC/Volt drops to OFF SOC/Volt, it will cut off the power of the load.

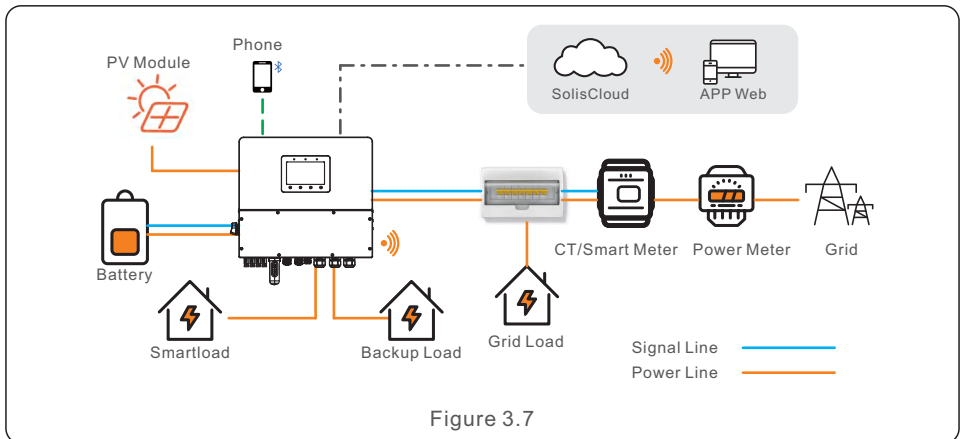



## 4.1 Select a Location for the Inverter

To select a location for the inverter, the following criteria should be considered:

- Exposure to direct sunlight may cause output power derating. It is recommended to avoid installing the inverter in direct sunlight.
- It is recommended that the inverter is installed in a cooler ambient which doesn't exceed 104°F/40°C.
- To select a location for the battery, please follow the battery manual specifications.

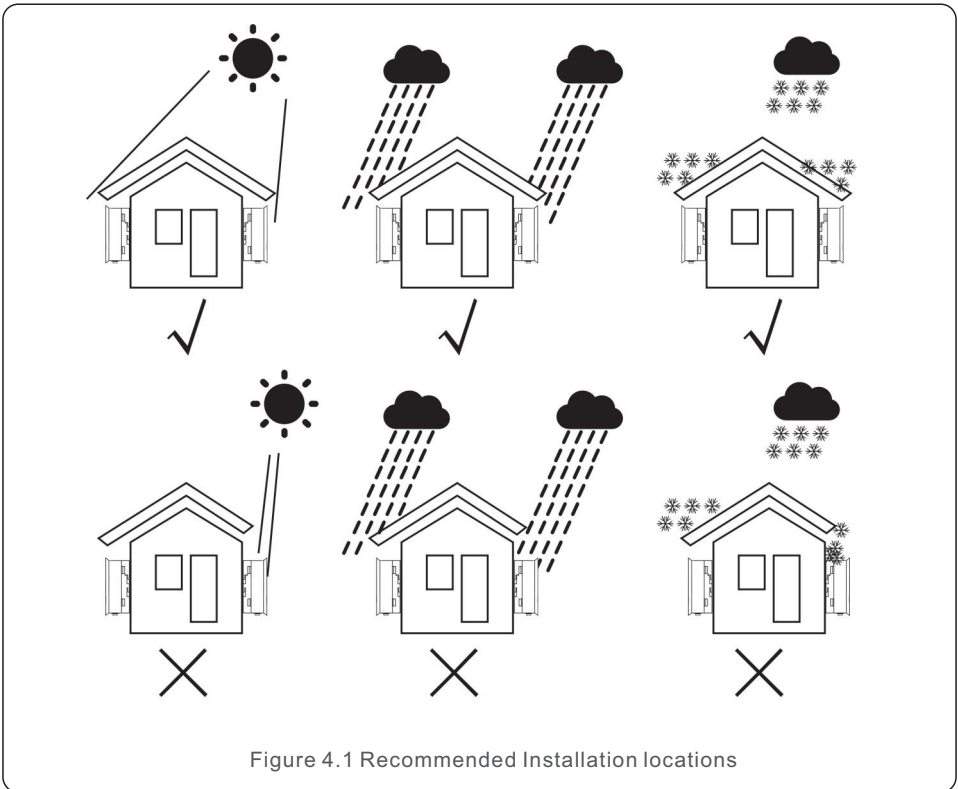

Figure 4.1 Recommended Installation locations



**WARNING: Risk of fire**

Despite careful construction, electrical devices can cause fires.

- Do not install the inverter in areas containing highly flammable materials or gases.
- Do not install the inverter in potentially explosive atmospheres.
- The mounting structure where the inverter is installed must be fireproof.

- Install on a wall or strong structure capable of bearing the weight of the machine.
- Install vertically with a maximum incline of +/- 5 degrees, exceeding this may cause output power derating.
- The fan of the inverter is the lower inlet wind, the upper outlet wind .  
To avoid overheating, always make sure the flow of air around the inverter is not blocked. A minimum clearance of 300mm should be kept between inverters or objects;  
In order to have enough space for installation and maintenance, we recommend that the front distance is  $\geq 500\text{mm}$ , which can be adjusted according to the actual situation.

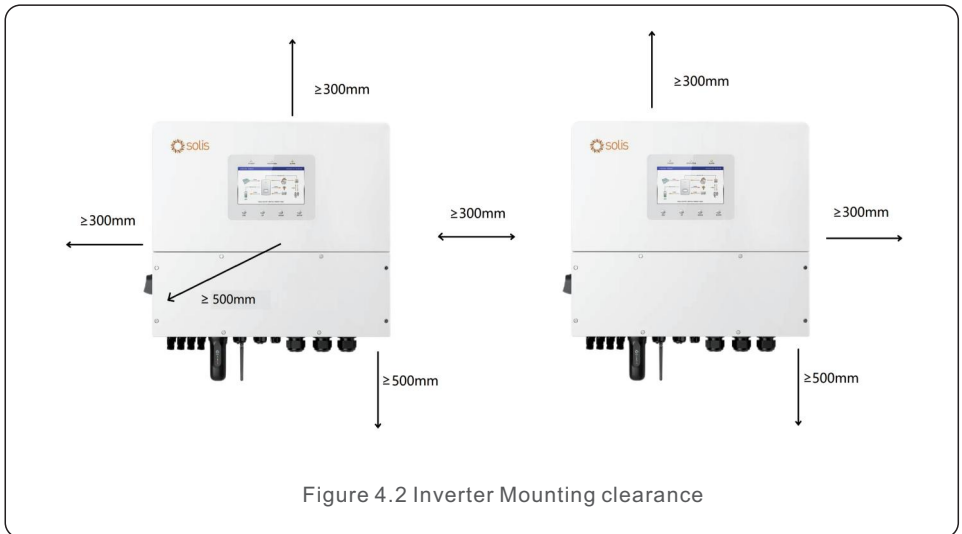

- Adequate ventilation must be provided.



**NOTE:**

Nothing should be stored on or placed against the inverter.



**NOTE**

If the inverter is installed in areas with high wind and sand, it is recommended to install a windproof and sand barrier above the inverter.

## 4.2 Mounting the Inverter

Dimensions of mounting bracket:

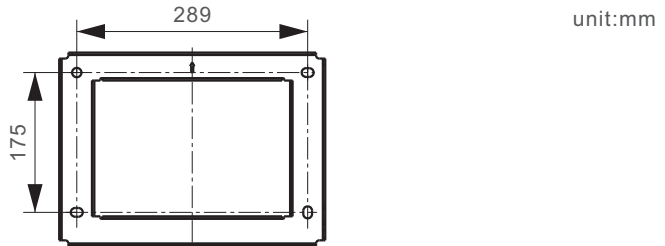

Figure 4.3 Inverter wall mounting

Once a suitable location has been found according to Section 4.1 and using Figure 4.3 as a guide, firmly attach the wall bracket to the wall.

The inverter shall be mounted vertically.

The steps to mount the inverter are listed below:

1. Select the mounting height of the bracket and mark the mounting holes.

For brick walls, the position of the holes should be suitable for the expansion bolts.

2. Lift up the inverter (be careful to avoid body strain), and align the back bracket on the inverter with the convex section of the mounting bracket. Hang the inverter on the mounting bracket and make sure the inverter is secure (see Figure 4.4)

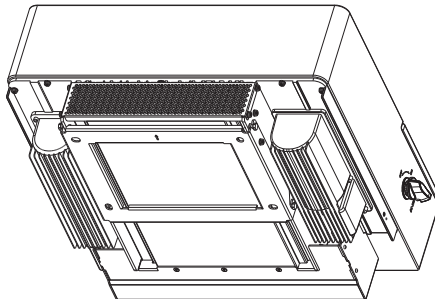

Figure 4.4 Wall Mount Bracket



**WARNING:**

The inverter must be mounted vertically.

## 4.3 PE Cable Installation

An external ground connection is provided at the right side of inverter.

Prepare OT terminals: M4. Use proper tooling to crimp the lug to the terminal.

Connect the OT terminal with ground cable to the both sides of inveter. The torque is 2N.m.

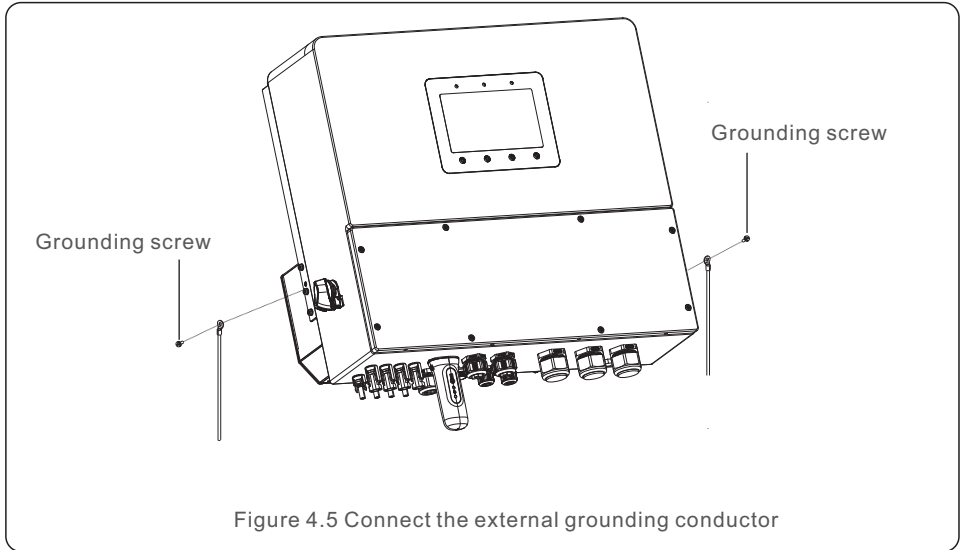

## 4.4 PV Input Cable Installation



Before connecting inverter, please make sure the PV array open circuit voltage is within the limit of the inverter.



Before connection, please make sure the polarity of the output voltage of PV array matches the "DC+" and "DC-" symbols.



Please use approved DC cable for PV system.

1. Select a suitable DC cable and strip the wires out by  $7\pm 0.5\text{mm}$ . Please refer to the table below for specific specifications.

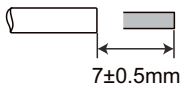

Cable type	Cross section (mm <sup>2</sup> )	
	Range	Recommended value
Industry generic PV cable	4.0~6.0 (10~8AWG)	4.0 (10AWG)

Figure 4.6

2. Take the DC terminal out of the accessory bag, turn the screw cap to disassemble it, and take out the waterproof rubber ring.

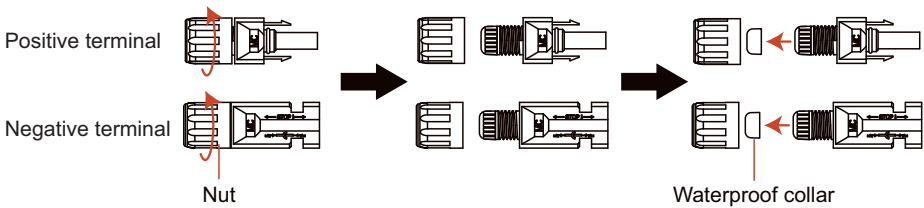
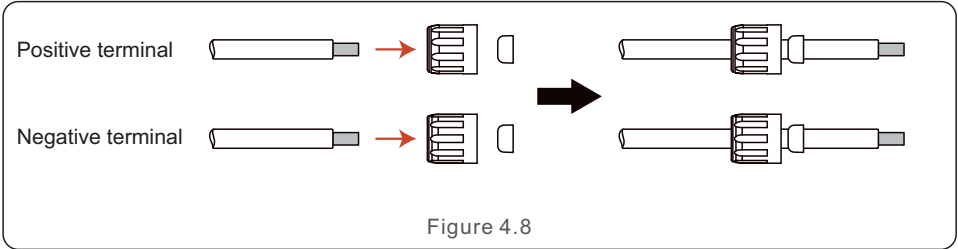
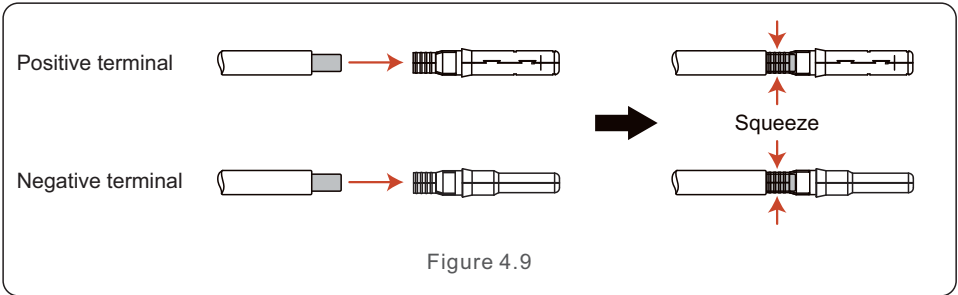

Figure 4.7

3. Pass the stripped DC cable through the nut and waterproof rubber ring.



4. Connect the wire part of the DC cable to the metal DC terminal and crimp it with the MC4 crimping tool.



5. Insert the crimped DC cable into the DC terminal firmly, then insert the waterproof rubber ring into the DC terminal and tighten the nut.

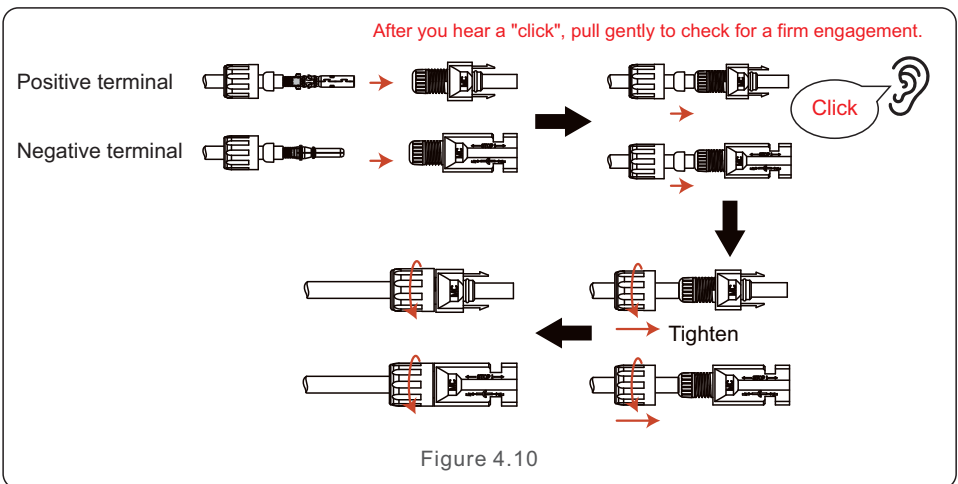

6. Measure PV voltage of DC input with multimeter, verify DC input cable polarity.

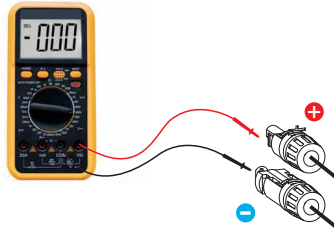

Figure 4.11

7. Connect the wired DC terminal to the inverter as shown in the Figure 4.12, and a slight "click" is heard to prove the connection is correct.

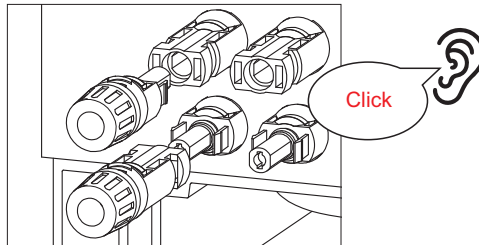

Figure 4.12



**CAUTION:**

If DC inputs are accidentally reversely connected or inverter is faulty or not working properly, it is NOT allowed to turn off the DC switch. Otherwise it may cause DC arc and damage the inverter or even lead to a fire disaster. The correct actions are:

\*Use a clip-on ammeter to measure the DC string current.

\*If it is above 0.5A, please wait for the solar irradiance to get reduced until the current decreases to below 0.5A.

\*Only after the current is below 0.5A, you are allowed to turn off the DC switches and disconnect the PV strings.

\* In order to completely eliminate the possibility of failure, please disconnect the PV strings after turning off the DC switch to avoid secondary failures due to continuous PV energy on the next day.

**Please note that any damages due to wrong operations are not covered in the device warranty.**

## 4.5 Battery Cable Installation



**DANGER:**

Before installing the battery cables, be sure that the battery is turned off. Use a multimeter to verify that the battery voltage is 0Vdc before proceeding. Consult the battery product manual for instructions on how to turn it off.

1. The battery (+) and (-) cables shall only be connected to the inverter BAT terminals.
2. Run the cables into the wire box. Strip 13mm off the ends of each cable.
3. Crimp the R-type connectors onto the cables. Do not over crimp the connectors.
4. Remove the terminal bolts and then insert them through the connector holes.
5. Put each bolt back into the proper place, be sure to not reverse the polarity.
6. Tighten the bolts with a torque wrench screwdriver following the torque specs.
7. Battery Breaker recommended size: two-pole, 63A, leakage current protector recommended Type C,  $I_{cc} \geq 20KA$ ,  $I_{cp}$ ,  $m \geq 350A$  fault current interrupting capacity at 800V/pole.

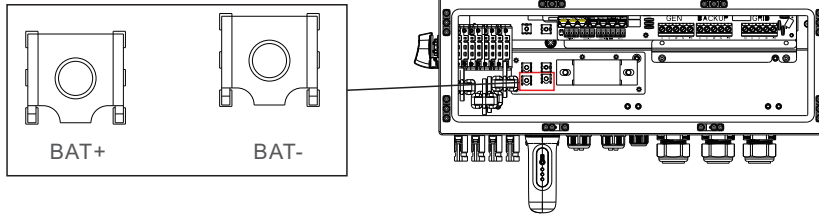

OT Terminal: R60-8, Recommended cable diameter: 8AWG(8.37mm<sup>2</sup>)

Figure 4.13 Battery cable connection



**NOTE:**

The battery fuse in the inverter wire box is replaceable. The replacement can only be done by a technician authorized by Solis. Fuse specification: 1000V/100A. The Max.temperature for connecting battery terminals is 105°C.



**NOTE:**

Before connecting the battery, please carefully read the product manual of the battery and perform the installation exactly as the battery manufacturer specifies in the manual.



## 4.6 AC Wiring



**DANGER:**

Before installing the AC cables, be sure that the OCPDs (breakers) are turned off.

Use a multimeter to verify that the AC voltages are 0Vac before proceeding.

There are three sets of AC output terminals and the installation steps for both are the same.

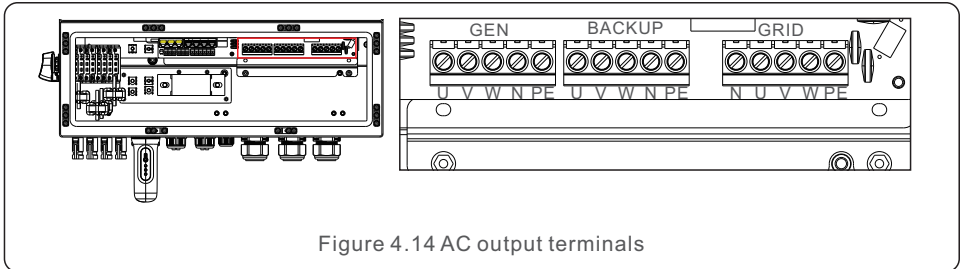

Figure 4.14 AC output terminals

Model	AC Grid	AC Backup/AC Gen	PE
Torque	4~5N.m	4~5N.m	4-5N.m
Recommend cross section	8~6AWG (6~10mm <sup>2</sup> )	10~6AWG (4~10mm <sup>2</sup> )	6AWG

1. Bring the AC cables for the backup loads panel (backup) and the main service panel (grid) into the inverter wire box. The backup loads panel should not be electrically connected to the main service panel.
2. Strip 13mm from the ends of each cable. Crimp the R-type connectors onto the ends.
3. Remove the terminal bolts, insert them into the connectors, then use a torque wrench to tighten the bolts down.
4. Please refer to the terminal labels to connect the AC wires to the correct terminals.
5. The grid inrush current is 8.5A and the duration is less than 5ms.
6. AC Breaker recommended size: four-pole, 63A, leakage current protector recommended Type C, Icc≥20KA, Icp, mr≥350A fault current interrupting capacity at 230V/pole.
7. Cable Gland are recommended torque for installation is 4-5Nm. In order to ensure waterproof effect, the operator regularly checks whether the installation is tight.



**NOTE:**

The Max.temperature for connecting AC terminals is 105°C.

## 4.7 CT Connection



**CAUTION:**

Make sure the AC cable is totally isolated from AC power before connecting the smart meter or CT.

The CT provided in the product box is compulsory for hybrid system installation. It can be used to detect the grid current direction and provide the system operating condition to hybrid inverter.

CT Model: 120A/40mA\_0.5%, ESCT-TA16 120A/40mA

CT Cable: Size – 2.3mm<sup>2</sup>, Length - 1m

Please install the CT on the phase lines at the system grid connection point and the arrow on the CT needs to point to the grid direction.

Lead the CT wires through the CT port at the bottom of the inverter and connect the CT wires to the 6 pin communication terminal block.

CT Wire	6 PIN Communication Terminal Block
White	Pin 1 (From Left to Right)
Black	Pin 2 (From Left to Right)

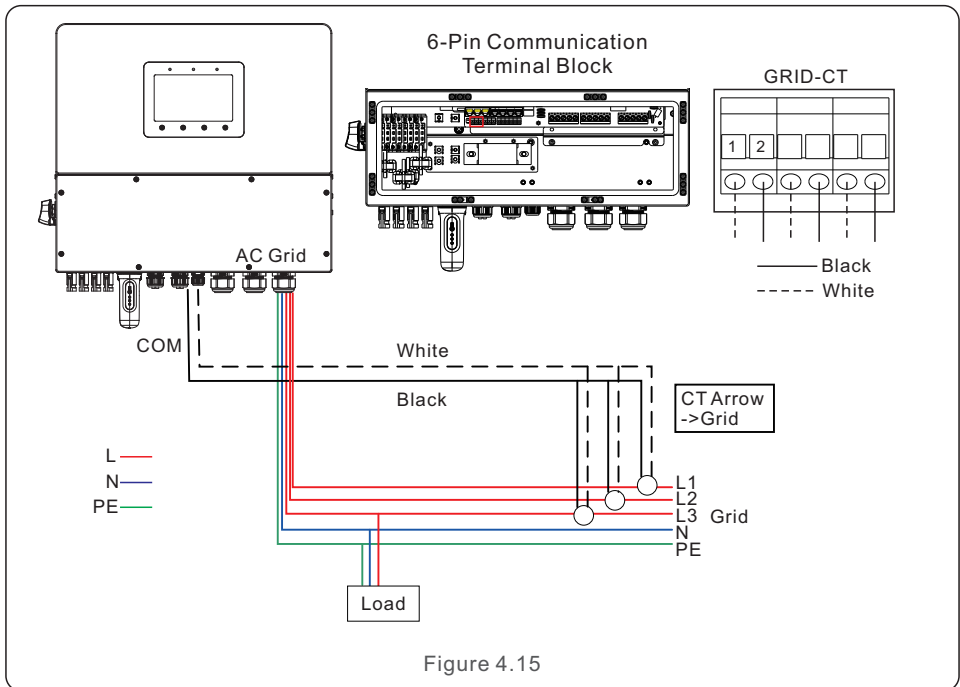
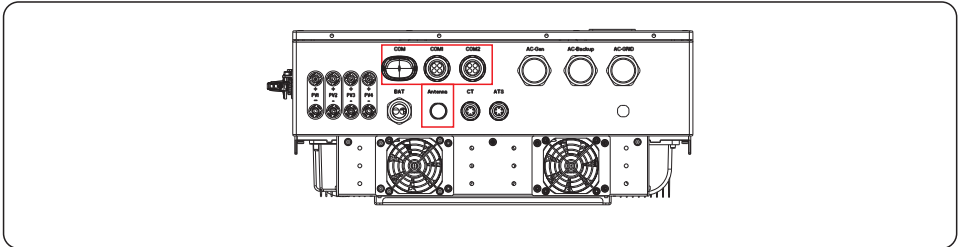

Figure 4.15

## 4.8 Inverter Communication

### 4.8.1 Communication Ports



Port	Port Type	Description
COM	USB	Used for Solis data logger connection
ANTENNA	Antenna	Used for antenna connection for built in Bluetooth signal
COM1	4 hole watertight cable gland	Used for RJ45 connection inside wiring box
COM2	4 hole watertight cable gland	Used for RJ45 connection inside wiring box

Wiring steps for COM1-COM2:

- Step 1. Loosen the cable gland and remove the watertight caps inside the cable gland based on the number of the cables and keep the unused holes with watertight cap.
- Step 2. Lead the cable into the holes in the cable gland.  
(COM1-COM2 Hole Diameter: 6mm)
- Step 3. Connect the cable to the corresponding terminals inside the wiring box.
- Step 4. Reassemble the cable gland and ensure there is no bending or stretching of the cables inside the wiring box.



**NOTE:**

The 4-hole fastening rings inside the cable gland for COM1 and COM2 are with openings on the side.

Please separate the gap with hand and squeeze the cables into the holes from the side openings.

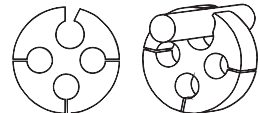

## 4.8.2 Communication Terminals

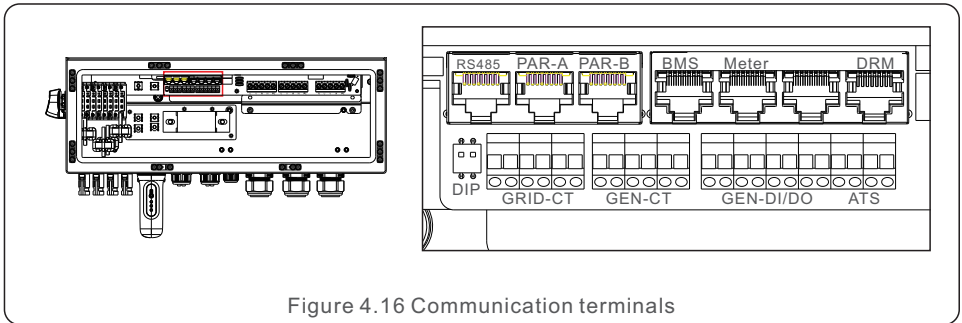

Figure 4.16 Communication terminals

Terminal	Type	Description
RS485	RJ45	Used for Ethernet communication.
PAR-A	RJ45	(Optional) Parallel operation communication port.
PAR-B	RJ45	(Optional) Parallel operation communication port.
BMS	RJ45	Used for CAN communication between inverter and Lithium battery BMS.
Meter	RJ45	(Optional)Used for RS485 communication between inverter and the smart meter.
COM	RJ45	Reserve.
DRM	RJ45	(Optional) To realize demand response or logic interface function, this function may be required in UK and Australia.
DIP Switch (2-1)	-	When a single inverter is running, DIP switch 1 and 2 shall be both at the bottom position. When multiple inverters are paralleled, DIP switch: Option 1: Both the first and last inverter (INV1 & INV3) have 1 of the DIP switch enabled (Either Pin1 or Pin2). Option 2: One of the first and the last inverter (INV1 or INV3) has 2 DIP switches enabled (Both Pin1 & Pin2)
GRID-CT	Cable	Connect grid Cts.
GEN-CT	Cable	Connect GEN Cts.
GEN	Dry contact	Connect GEN .
DI/DO	Dry contact	Connect Heat Pump.
ATS	Reserve	

## 4.8.3 BMS terminal connection

### 4.8.3.1 With lithium battery

CAN communication is supported between inverter and compatible battery models. Please lead the CAN cable through the COM1 or COM2 port of the inverter and connect to the BMS terminal with RJ45 connector.

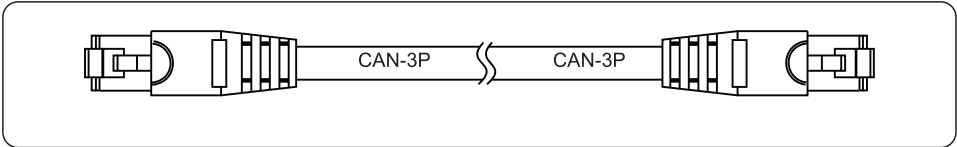

**NOTE:**

Before connecting CAN cable with the battery, please check whether the communication pin sequence of the inverter and the battery match; If it does not match, you need to cut off the RJ45 connector at one end of the CAN cable and adjust the pin sequence according to the pin definitions of both inverter and battery.

Pin definition of the inverter BMS port is following EIA/TIA 568B.  
 CAN-H on Pin 4: blue  
 CAN-L on Pin 5: blue/white

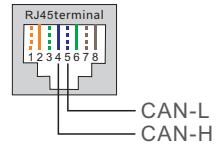

### 4.8.4 Meter Terminal Connection (Optional)

If a smart meter is preferred to be installed other than the provided CT, please contact Solis sales rep to order the smart meter and corresponding meter CT. Please lead the Meter RS485 cable through the COM1 or COM2 port of the inverter and connect to the Meter terminal with RJ45 connector.

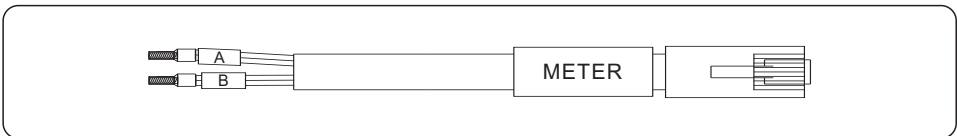

**NOTE:**

Pin definition of the Meter Terminal is following EIA/TIA 568B.  
 RS485A on Pin 1: Orange/white  
 RS485B on Pin 2: Orange

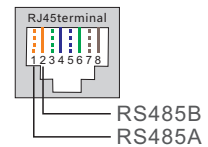

Meter Configuration: 40mA Meter+120A/40mA CT;MODEL:SDM630MCT+ESCT-TA16  
 Separate Kit: 5A Meter+300A/5A CT  
 MODEL: SDM630MCT V2+ESCT-T50

## 4.8.5 DRM port connection (Optional)

### 4.8.5.1 For remote shutdown function

Solis inverters support remote shutdown function to remotely control the inverter to power on and off through logic signals.

The DRM port is provided with an RJ45 terminal and its Pin5 and Pin6 can be used for remote shutdown function.

Signal	Function
Short Pin5 and Pin6	Inverter generates
Open Pin5 and Pin6	Inverter shutdown in 5s

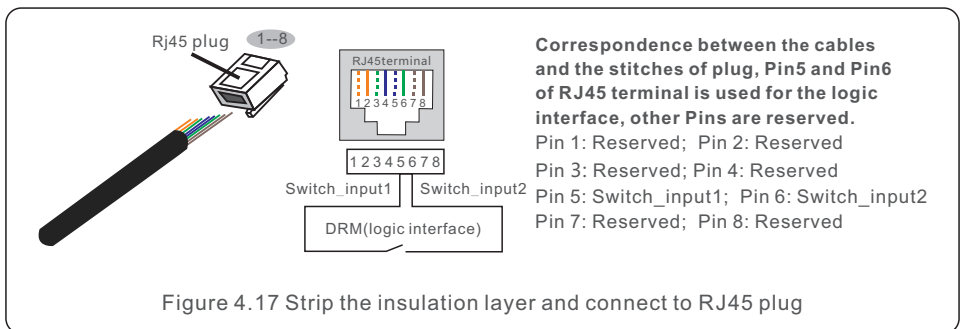

### 4.8.5.2 For DRED Control Function (For AU and NZ Only)

DRED means demand response enable device. The AS/NZS 4777.2:2020 required inverter need to support demand response mode(DRM).

This function is for inverter that comply with AS/NZS 4777.2:2020 standard.

A RJ45 terminal is used for DRM connection.

Pin	Assignment for inverters capable of both charging and discharging	Pin	Assignment for inverters capable of both charging and discharging
1	DRM 1/5	5	RefGen
2	DRM 2/6	6	Com/DRM0
3	DRM 3/7	7	V+
4	DRM 4/8	8	V-



**NOTE:**

Solis hybrid inverter is designed to provide 12V power for DRED.

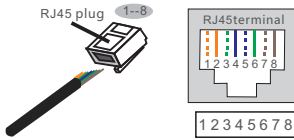

**Correspondence between the cables and the stitches of plug**  
 Pin 1: white and orange ; Pin 2: orange  
 Pin 3: white and green; Pin 4: blue  
 Pin 5: white and blue; Pin 6: green  
 Pin 7: white and brown; Pin 8: brown

Figure 4.18 Strip the insulation layer and connect to RJ45 plug

### 4.8.6 RS485 Port connection (Optional)

If a 3rd party external device or controller needs to communicate with the inverter, the RS485 port can be used. Modbus RTU protocol is supported by Solis inverters.

To acquire latest protocol document, please contact Solis local service team or Solis sales.



**NOTE:**  
 Pin definition of the RS485 Port is following EIA/TIA 568B.  
 RS485A on Pin 1: orange/white  
 RS485B on Pin 2: orange

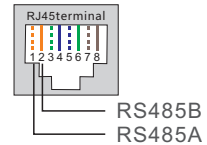

### 4.8.7 Parallel Inverter Connection (Optional)

Up to 6 units of the inverter can be connected in parallel.

Please connect the paralleled inverters by using P-A and P-B terminals.

Standard CAT5 (≤5m, between two inverter) with shielding layers internet cable can be used.

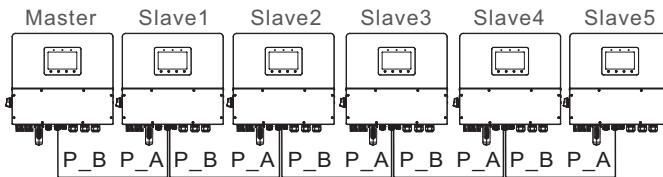

Figure 4.19 Parallel Terminal Connection



**NOTE:**  
 Please upgrade the latest software version before you want use the inverter in parallel mode.

## 4.8.8 12-pin Communication Terminal Block

Terminal Block Connection Steps:

- Step 1. Lead the wires through the hole in COM1 or COM2 port (Hole Diameter: 2 mm)
- Step 2. Strip the wires for 9mm length
- Step 3. Use slot type screwdriver to press the block on the top
- Step 4. Insert the exposed copper part of the cable into the terminal.
- Step 5. Remove the screwdriver and the terminal will clamp down on the exposed copper part.
- Step 6. Give the cable a gentle tug to ensure that it is firmly secured.

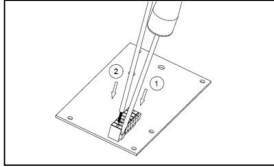

### 4.8.8.1 Heat Pump Control Signal Connection

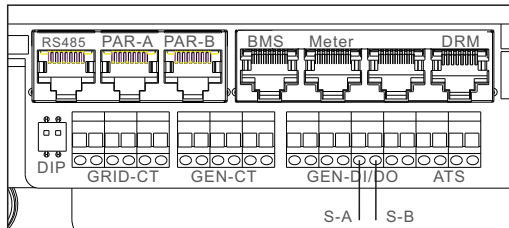

Figure 4.20



### 4.8.8.2 G-V Terminal Connection

The G-V terminal is a voltage-free dry contact signal for connecting with generator's NO relay to start up the generator when necessary.

When generator operation is not needed, Pin1 and Pin2 is in open circuit.

When generator operation is needed, Pin1 and Pin2 is in short circuit.

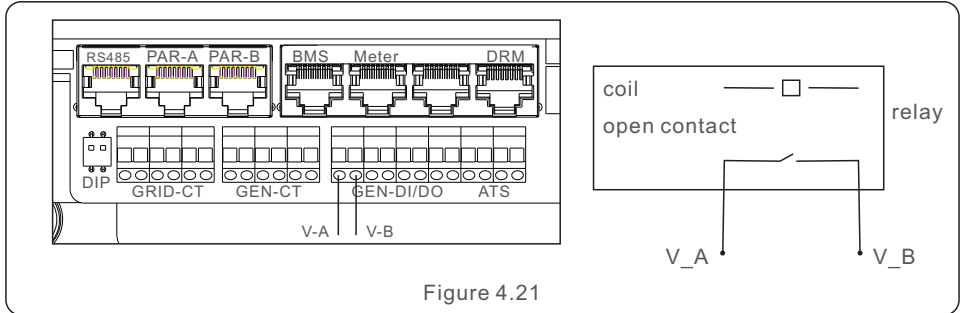

Figure 4.21

### 4.8.8.3 ATS240V Terminal Connection(Reserve)

The ATS240V terminal will output 230V AC voltage when inverter is connected to the grid, when the grid is not available, it will output 0V, then the ATS will transfer to generator.

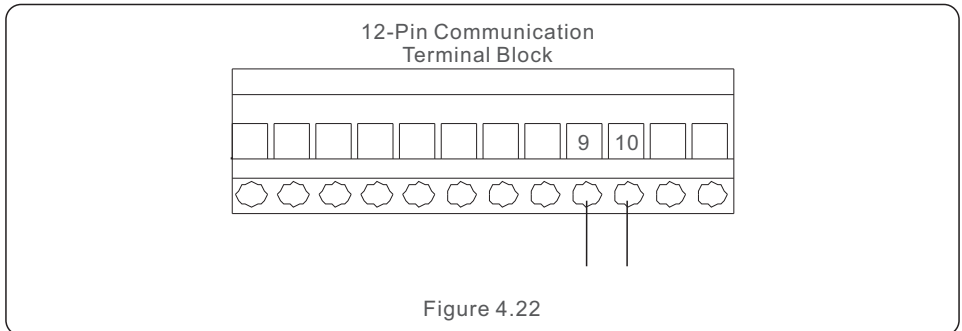

Figure 4.22

## 4.9 Inverter Remote Monitoring Connection

The inverter can be remotely monitored via WiFi, LAN or 4G.

The USB type COM port at the bottom of the inverter can connect to different kinds of Solis dataloggers, enabling remote monitoring through the SolisCloud platform.

To install Solis data loggers, please refer to the corresponding user manuals of Solis data loggers.

The Solis data loggers are optional and can be purchased separately.

Dust cover is provided in the inverter package in case the port is not used.



**WARNING:**

The USB type COM port only supports Solis dataloggers. It is forbidden to be used for other purposes.

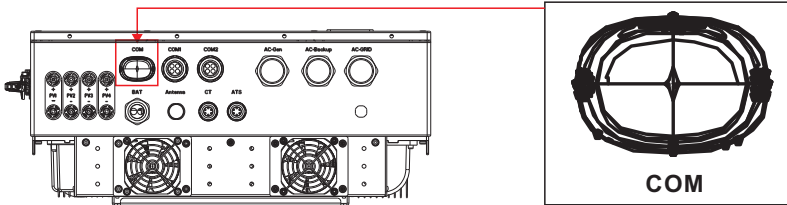

Figure 4.23

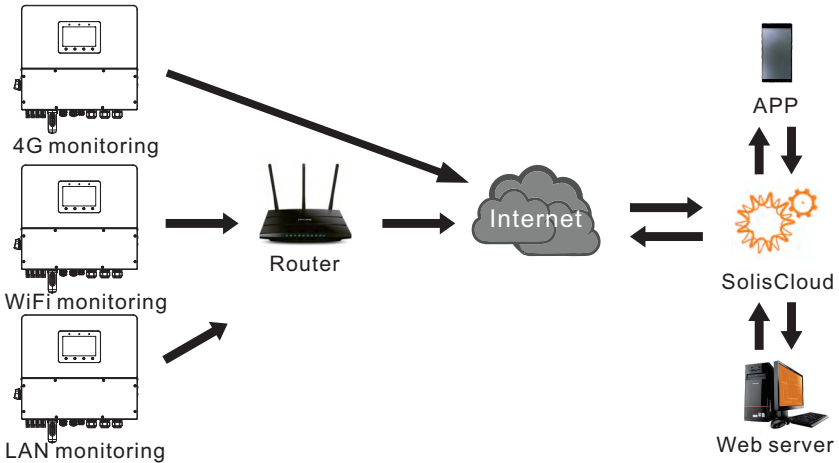

Figure 4.24 Wireless communication function

## 5.1 Preparation of Commissioning

- Ensure that all the devices are accessible for operation, maintenance and service.
- Check and confirm that the inverter is firmly installed.
- Space for ventilation is sufficient for one inverter or multiple inverters.
- Nothing is left on the top of the inverter or battery module.
- Inverter and accessories are correctly connected.
- Cables are routed in safe place or protected against mechanical damage.
- Warning signs and labels are suitably affixed and durable.
- Bluetooth Antenna has been connected to the Antenna port of the inverter.
- An Android or IOS mobile phone with Bluetooth function is available.
- SolisCloud APP is installed on the mobile phone.

There are three ways to download and install the latest APP:

1. You can visit [www.soliscloud.com](http://www.soliscloud.com) to download the latest version APP.
2. You can search “**SolisCloud**” in Google Play or App Store.
3. You can scan this QR code below to download “**SolisCloud**”.



## 5.2 Commissioning Procedure

Step 1: Measure DC voltage of PV strings and battery and ensure the polarity is correct.

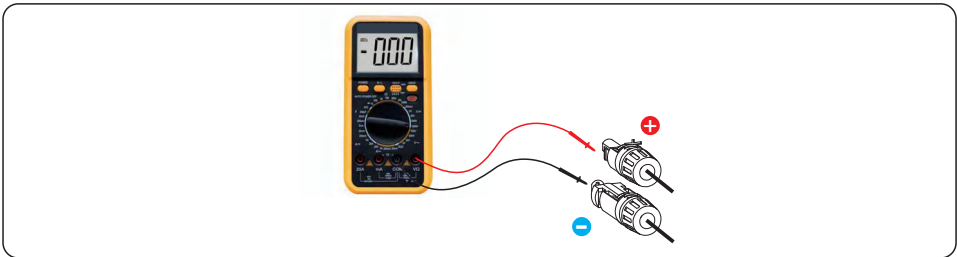

Step 2: Measure AC voltage and frequency and ensure they are within local standard.

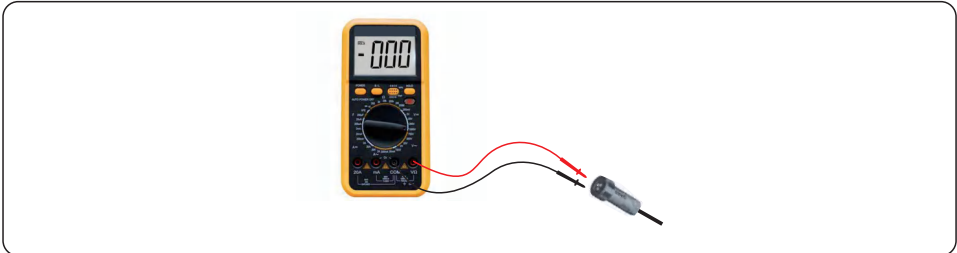

Step 3: Switch on the external AC breaker to power on the inverter control board.  
(Bluetooth signal available)

## 5.3 Log in the APP via Bluetooth

Step 1: **Connect with Bluetooth.**

Turn on Bluetooth switch on your mobile phone and then open the SolisCloud APP. Click “More Tools”->”Local Operation”->”Connect with Bluetooth”

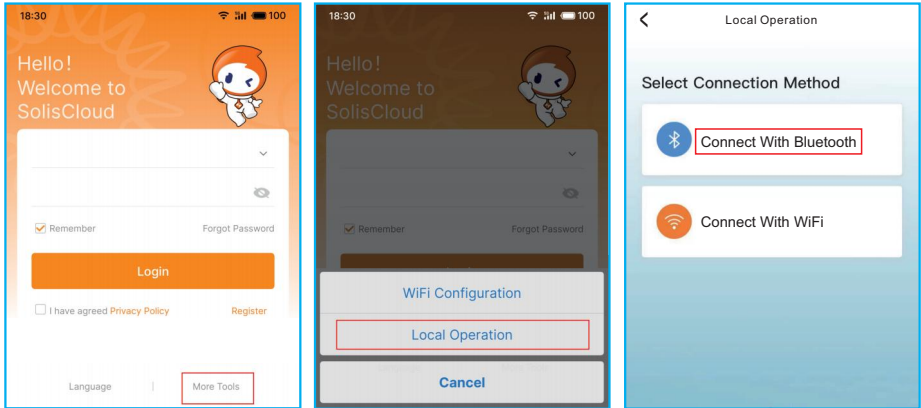

Step 2: Select the Bluetooth signal from the inverter. (Bluetooth Name: Inverter SN)



Step 3: **Login account.**

If you are the installer, please select the account type as Installer. If you are the plant owner, please select the account type as Owner. Then set your own initial password for control verification. (The first log-in must be finished by an installer in order to do the initial set up)

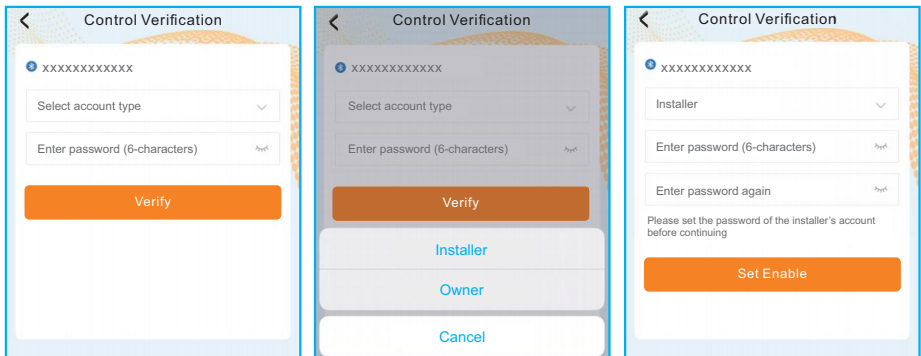

Step 4: After the log in for the first time, initial settings are required.

**Step 4.1: Set the inverter date and time.**

You can set to follow the time on your mobile phone.

**Step 4.2: Set the battery model.**

It must be based on the battery model that is actually connected to the inverter.

If there is no battery connected for the moment, please select “No Battery” to avoid alarms.

The default setting for battery over discharge SOC is 20%, force charge SOC is 10%.

**Step 4.3: Set the meter setting.**

It must be based on the meter type that is actually connected to the inverter.

If the grid does not need to be connected to an N-Line, select disconnected

If there is no meter connected for the moment, please select “No Meter” to avoid alarms.

It is suggested to install the meter at the system grid connection point and select “Meter in Grid”.

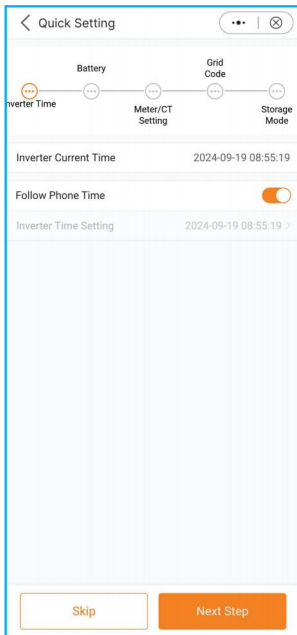

Step 4.1

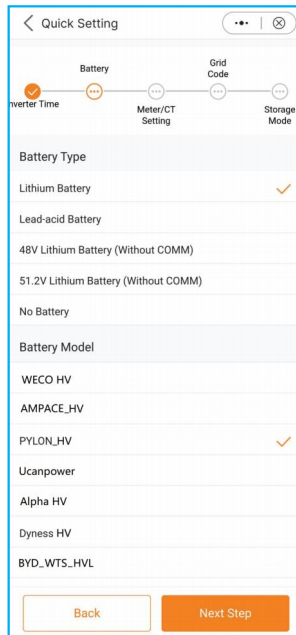

Step 4.2

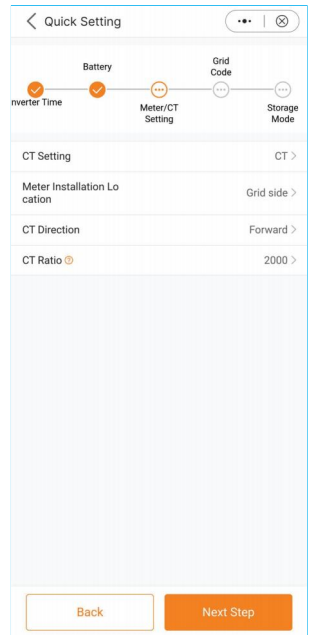

Step 4.3

### Step 4.4: **Set the grid code setting.**

Please select the grid code based on the local grid network requirements.

### Step 4.5: **Set the work mode setting.**

Recommended setting is Self-Use Mode. This mode will maximize the use of PV power generation for household electricity, or store it in batteries and use it for household electricity.

Allow export: Allow power output to the grid in Self-use mode. If you do not want to send power to the grid, do not turn it on.

Max export power: Limit the maximum power sold to the grid.

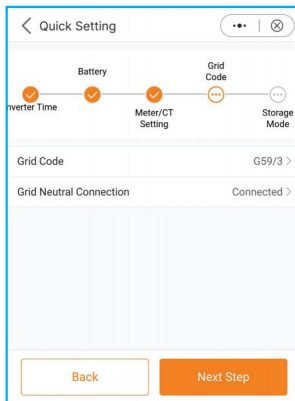

Step 4.4

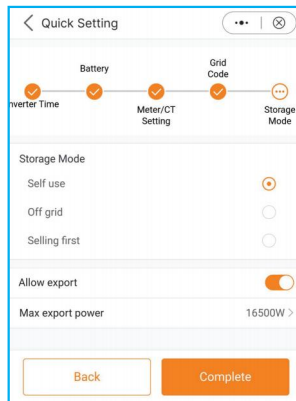

Step 4.5

### Step 5: **Setup complete.**

Now the initial settings on the inverter have been set and you can switch on the inverter's DC switch and switch on battery breaker to start up the system. You can also explore in the APP to check the operating data, alarm message or other advanced settings.

## 5.4 Shutdown procedure

Step 1. Turn off the AC breaker at the grid connection point.

Step 2. Turn off the DC switch of the inverter.

Step 3. Turn off the battery breaker.

Step 4. Wait until the device is powered off, and the system shutdown is complete.

## 5.5 Work Mode and Settings

### APP operation system overview

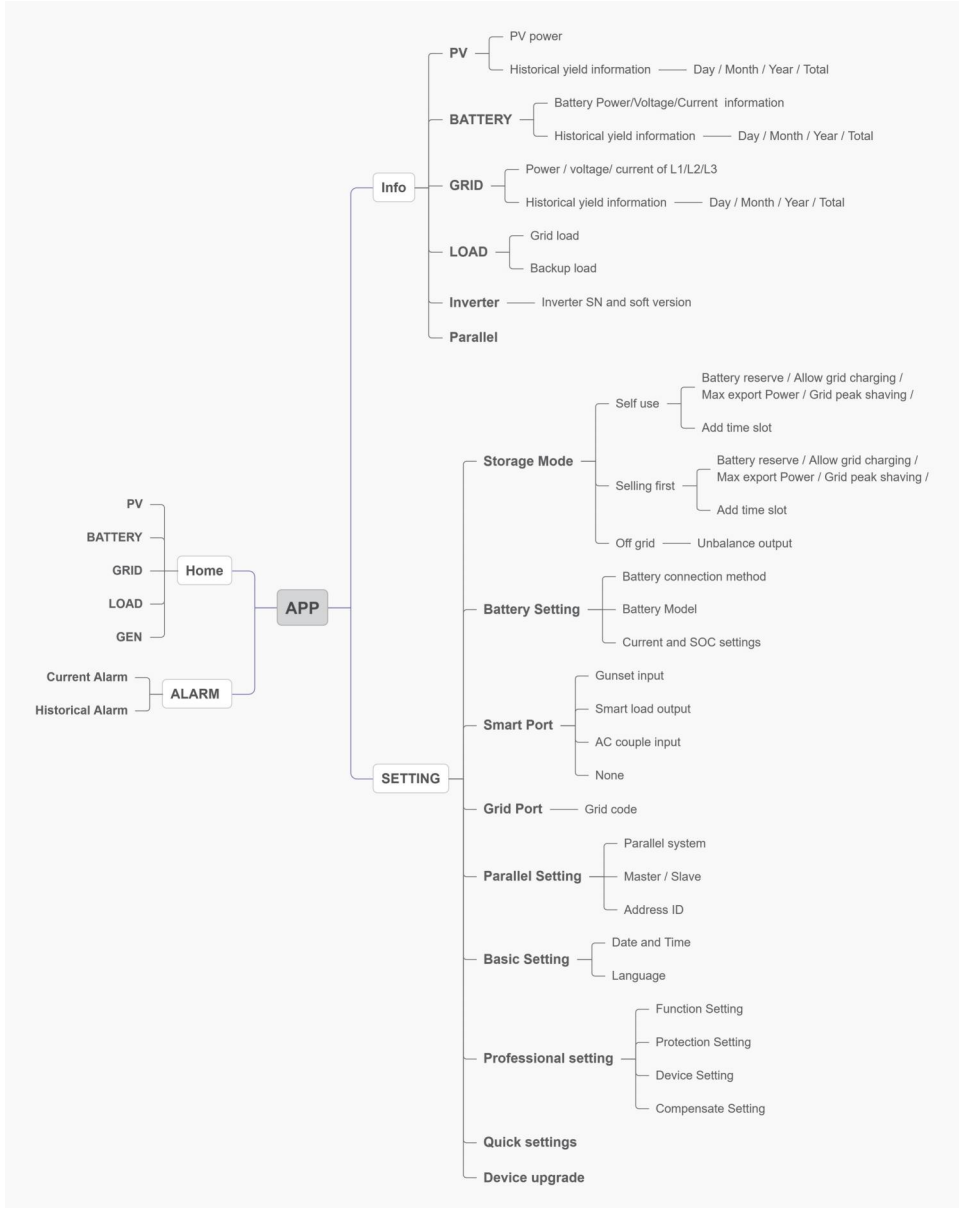

## 5.5.1 Self-Use mode

Load priority: load>battery>grid

Power supply priority: PV>battery>grid>DG

This mode applies to the area that has low feed-in tariff and high energy price.

The PV power will prioritize supplying energy to the load and charging the battery, with any surplus power being fed into the grid. During periods without PV power at night or when the PV power is insufficient, the battery will discharge to support the load.

- Supports TOU settings in this mode.
- Supports Battery Reserve function in this mode.

### How to set Self-Use mode?

APP: setting--storage mode-self use

A. Self-Use Mode is activated without any specific times set for the battery to be charged/discharged, and the battery reserve is not switched on.

Note: Solis recommends activating the 'Allow Grid Charge' option. Once the battery reaches the Forcecharge SOC, it will use the grid to charge the battery, preventing it from being deep discharged.

B. The Self-Use Mode provides you with the option to set a Battery reserve value. Please toggle the switch to activate the battery reserve mode.

C. The Self-Use Mode provides you with the option to set whether allow power output to the grid and the max value.

D. If there is an error with your meter or CTs, open "Export power calibration" to calibration; In addition, you can set a small negative value (like: -50W) to ensure that no power is sent to the grid to achieve Zero export Power.

E. When your load is unbalanced in the three-phase distribution, turn on unbalanced output. Supports 150% Unbalanced Loads on both the Grid and Backup Port, single-phase load 1/2 rated power.

F. You can set the value of Grid peak shaving, Limit the power that inverters can obtain from the grid to prevent exceeding regulatory requirements or the power line capacity due to excessive power. G. With the Add time slot, you can customize 6 stages of charging and 6 stages of discharging in one day.



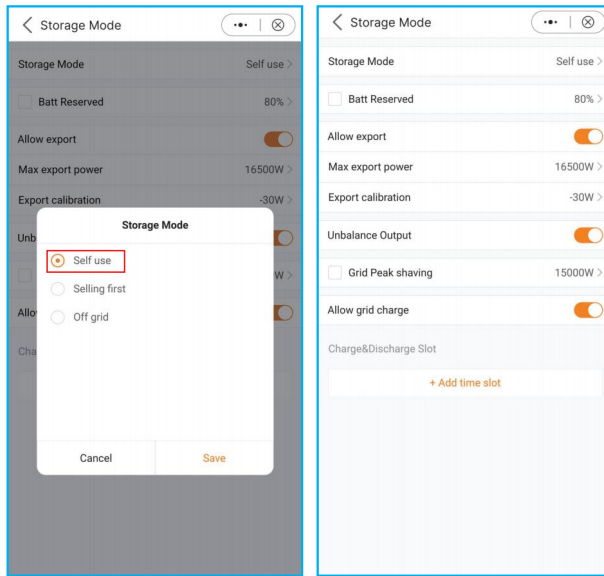

**Batt reserved:** Lithium battery: default 80%, adjustable range (the recommended value is more than 80%, to ensure that the battery has enough energy to supply the load after the grid is off ;

**Lead acid battery:** Default 100%, cannot be set.

**Allow export:** Allow power output to the grid in Self-use mode. If you do not want to send power to the grid, do not turn it on.

**Max export power:** Limit the maximum power sold to the grid.

**Export power calibration:** As some CTs/meters may have errors in practical applications, this setting value can be used for compensation. The range is "-500w ~ +500w"

**Unbalanced output:** Allow three-phase output imbalance, single-phase maximum load 50% of rated power. For example: 15kW inverter, single-phase maximum load 7.5kW.

**Grid peak shaving:** Limit the power that inverters can obtain from the grid to prevent exceeding regulatory requirements or the power line capacity due to excessive power. When the grid supplies power to the load while charging the battery, it will limit the power used to charge the battery, so that the total power does not exceed the set value. If the grid only supplies power to the load and does not charging the battery, it is not limited by the setting value.

**Allow grid charging:** Allow the battery to be charged by the grid.

**Charge/Discharge Slot:** When the time is between Start and Stop, the system will charge/discharge the battery according to the set Current until the set "SOC/voltage" is reached.

## 5.5.2 Selling first mode

Load priority: load>grid>battery

Power supply priority: PV>battery>grid>DG

This mode applies to the area that has high feed-in tariff and export control.

The PV power will prioritize supplying energy to the load. Then any surplus is directed into the grid.

If there is a feed-in limitation, the excess power will charge the battery.

- Supports TOU setting in this mode.
- Supports Battery Reserve function in this mode.

How to set selling first mode?

APP: setting--storage mode--selling first

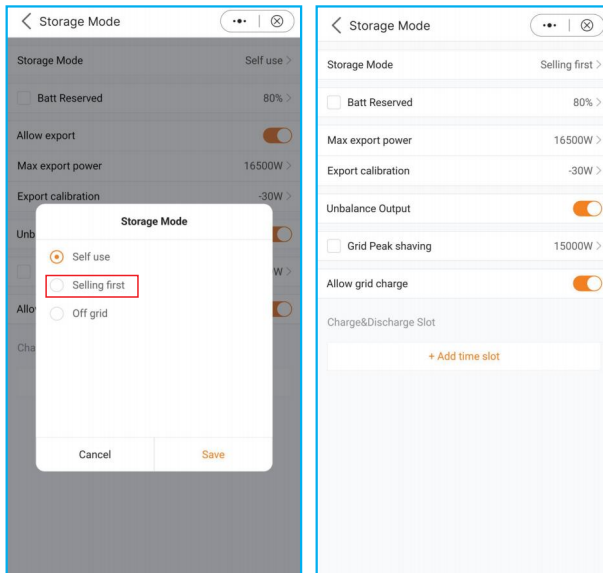

## 5.5.3 Off-Grid mode

Load priority : load>battery

Power supply priority: PV>battery>DG

- This mode applies to the area not covered by the grid or when the system is not connected to the grid.
- When a power outage is detected in a grid-tied system, the system will automatically will automatically enter in the off-grid, supplying only the backup load.
- The user can also manually set this mode, supplying only the backup load.

How to set Off-Grid mode?

APP: setting--storage mode--off-grid

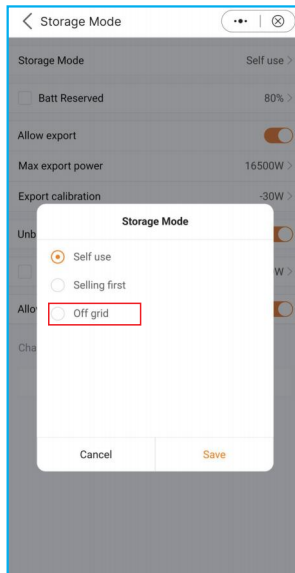

## 5.6 TOU Function Settings

This function applies to the area with peak-valley price. Set the system to charge the battery in valley price and discharge in peak price to improve benefits.

Supports 6 customizable charge/discharge time settings, while the battery will charge/discharge at a set current.

Supports TOU function settings in self-use mode, feed in priority mode.

There are 6 customizable charging settings and 6 customizable discharging settings.

How to set TOU Function?

Press "+Add Time Slot" to add a charging/discharging time period.

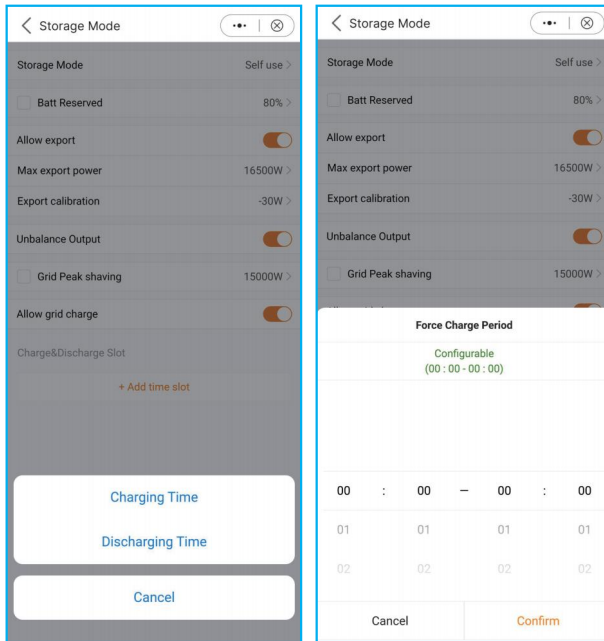

## 5.7 Battery Settings

The battery section of the app offers numerous options to customize the interaction between the inverter and the battery. Here, we provide explanations for the functions and features available in this section, allowing users to tailor the inverter's behavior to their specific preferences and requirements.

**Battery Type:** Please select the correct Type of the battery. Lead-acid battery and lithium battery.

**Battery Mode:** Please select the correct model of the battery. If you don't have a battery, choose "No battery" to ensure accurate configuration.

**Max Charging/Discharging Current:** Choose the maximum charge/discharge current that you wish to. This selection allows you to customize the charging and discharging parameters based on your preferences and requirements.

**Overdischarge SOC:** The Overdischarge SOC (State of Charge) is the minimum battery charge level to which the inverter will discharge. It acts as a safeguard to prevent the battery from discharging beyond this specified threshold, ensuring its longevity and health.

**Recovery:** The battery can discharge when the SOC/Voltage reaches the set value.

**Forcecharge:** The Forcecharge SOC for the battery is the minimum state of charge(SOC) at which the inverter initiates charging the battery from the grid. It specifies the threshold below which the inverter actively engages in recharging the battery to maintain optimal performance.

**Battery saving:** Reduce battery loss. The necessary power for the operation of the inverter preferentially obtains from the grid, not from the battery.

**Max charge SOC:** The maximum SOC/Voltage that the battery can be charged to. Default 100%. Some batteries may alarm overvoltage when fully charged, and limiting protection will not be triggered if not fully charged.

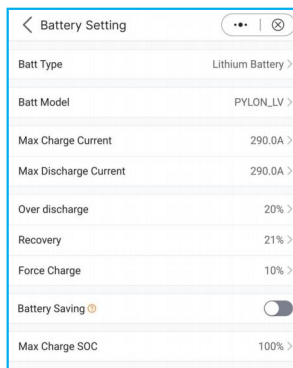

## 5.8 Battery Functions setting

If you need more Function Settings for the battery, you can go to Setting--Professional Setting--Function Setting.

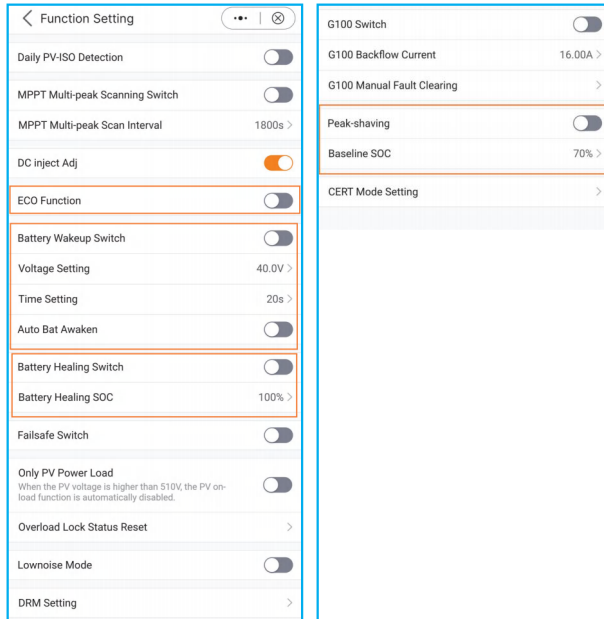

**ECO function:** To protect the battery, If PV power is lower than 100W and SOC below overdischarge SOC, The inverter will take power from the grid instead of battery, to maintain standby state, indicator and communication.

**Battery Wakeup Switch:** Battery wake-up can be supported in case of only PV or only Grid. This function supports manual and automatic operation, the battery can be awakened from the dormant state and charged above the overdischarge SOC.

Wake up voltage&time can be set:

Voltage: default 120V, range :120-600V;

Time: default 180s, range :20s-300s;

The wake up current depends on the battery, up to 6A.

**Battery Healing Switch:** When the lithium battery maintains low power for a long time, the battery SOC measurement is not accurate, It is necessary to charge the battery to 100 % from low power level to ensure the healthy and stable operation of the battery. Working logic: PV+grid charge the battery from Forcecharge SOC to overdischarge SOC , then grid stops charging, PV gives priority to charging the battery to Battery Healing SOC. And the battery does not discharge before reaching the set Battery Healing SOC.

**Battery Peak shaving:** In this function, the force charge power will be dynamically adjusted and not exceed the set value minus the load power when force charging.

## 5.9 Smart port settings

### 5.9.1 Generator setting

APP: setting--Smart Port

In single system, Diesel Generator can be connected via GEN port or ATS on Grid side. If though GEN port, it will only supply power to the Backup load. It is recommended that the power be greater than the backup load power.

If it is necessary to supply power to the grid side load, it is recommended that the generator be connected through ATS on grid side;

In parallel-system scenarios, connecting DG via ATS is recommended, Gen port is also supported;

When the generator is connected to the system, it is necessary to correctly select the location of the generator to avoid system failure or generator damage.

A. Select Genset input

B. Set the Genset rated power.

C. When you want to manually control the start and stop of the generator, enable needs to be selected.

D. When you want the generator to automatically start and stop according to the battery SOC, please select the Automatic.

The generator will start when the battery SOC drops to the ON SOC, and stop when the SOC reaches the OFF value.

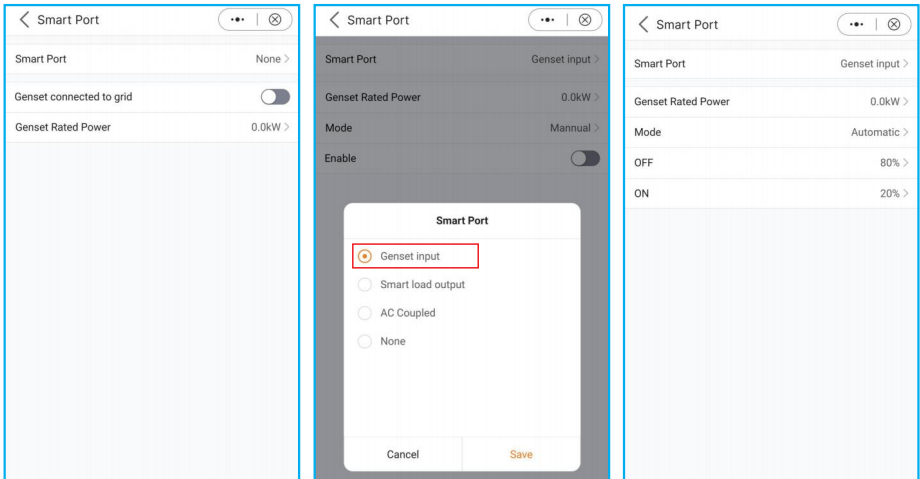

## 5.9.2 AC coupled setting

APP: setting--Smart Port

With an existing PV plant connected to the system, it is recommended that:

Grid-tied inverter power < rated AC power of S6 inverter.

In an on-grid scenario, when the third-party grid-connected inverter is connected, the system cannot control the output power of the third-party grid-tied inverter, so feed-in limitation cannot be achieved;

When connected in off-grid scenario, the third-party grid-tied inverter needs to set the correct grid code, and has the function of over-frequency load shedding & under-frequency load rising, so that the system can adjust the frequency to control the output power of the grid-tied inverter.

When the system is connected to the generator, it cannot be connected to the grid-tied inverter, as there's a risk of damaging the generator.

A. Select the AC couple input.

B. Set the Max frequency according to the specification of the PV inverter.

The hybrid uses Freq-Watt to control the output of the PV inverter. Please consult with the PV inverter's manufacturer to confirm the correct setting procedures of its Freq-Watt response first.

When  $SOC \leq 70\%$ , start inverter, when  $SOC \geq 85\%$ , Hybrid raises the frequency to the set value, stop inverter.

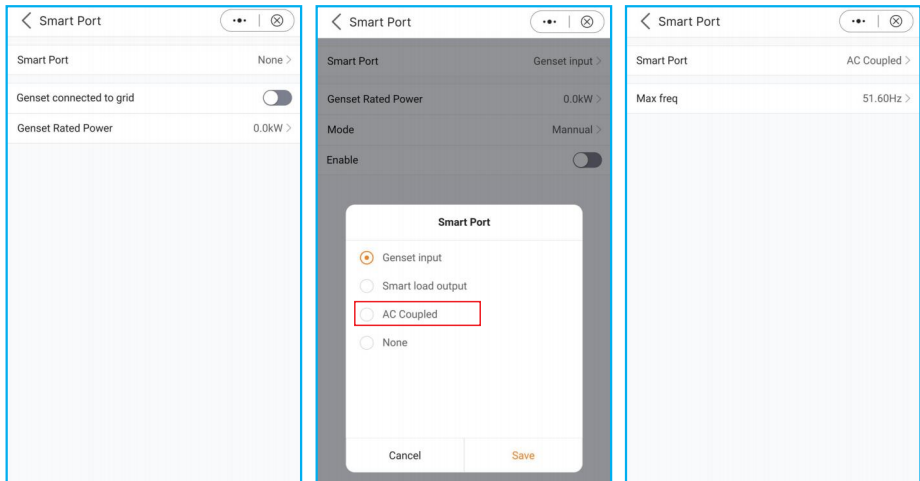



## 5.9.3 Smartload setting

APP: setting--Smart Port

The Gen port has extended power, which can be used as Smart load output. When the battery SOC/Volt reach the ON set value, the smart port will supply power to the load. When the battery SOC/Volt drops to OFF SOC/Volt, it will cut off the power of the load.

A. Select Smart load output.

B. Select On grid always on or Off grid always off

On grid always on: smart port will always supply power to smart load when the grid is available.

Off grid always off: smart port will cut off power supply to smart load when the grid is off.

C. Set the OFF value and ON value to control the on/off of the load based on the battery level.

When the battery SOC/Volt drops to the OFF SOC/Volt, the system will cut off the power of smart load to ensure sufficient power for Backup load. When the battery SOC/Volt reaches the ON SOC/Volt, the smart port will supply power to smart load.

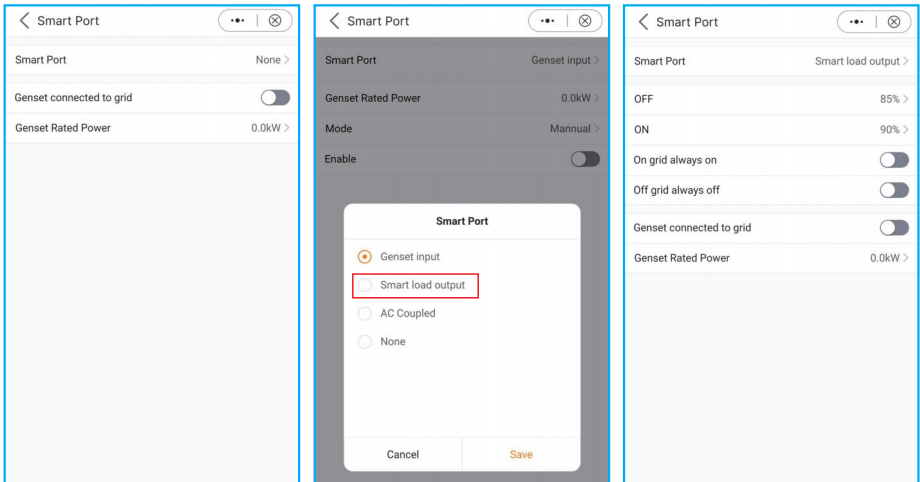

## 5.10 Grid port settings

APP: setting--Grid Port

Select grid code that meet the local regulations; If the grid is three-phase and three-line, choose Disconnected the N-line.

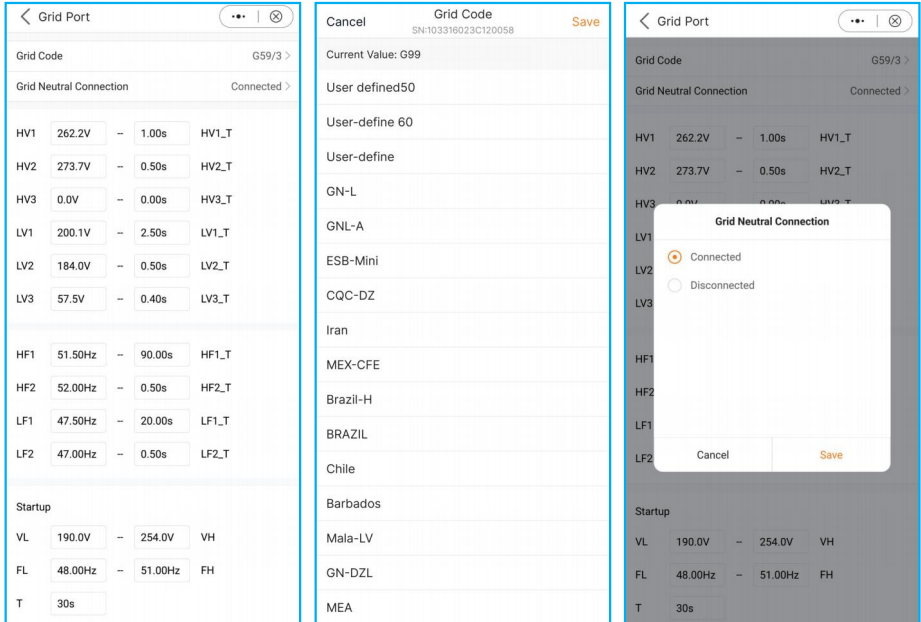

## 5.11 Parallel Settings

APP: setting--Parallel setting

The first inverter must be set as the Master.

The first inverter address is set to 1, the second to 2, and so on

(Note: that the address cannot be set to 0 and the physical address of the master must be 1)

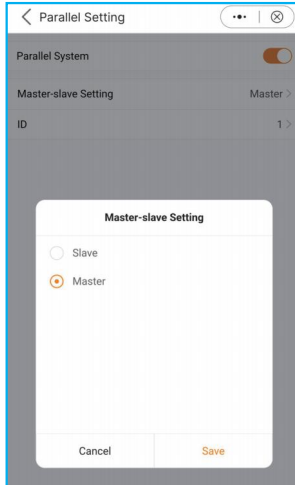

## 5.12 Only PV power load function

### 1. Function Definition

For PV generation is not stable, the default setting of S6 energy storage machine don't support only PV power the load.

But for meeting the some customers' special requirements, we develop the **Only PV Power Load** function, when the PV power > the load power, you can use this function.

Because the PV power is not stable and the load is also not always stable, it is possible to happen that PV power < load power, when it occurred, the load will shut down and **after 3 minutes**, the inverter tries to restart the load for the first time, **after 5 minutes**, the second time, and **after 10 minutes**, the third time. If the third attempt to restart the load is still not successful, the inverter will not try to restart, and it needs to be manually reset and restarted.



### NOTE:

1. Only PV Power Load function is closed by default. If you need to use it, you need to open it by yourself.
2. Software: Ensure that the current DSP and HMI software is the latest version.

## 2. Solis APP Setting

### Setting--Professional Setting--function Setting

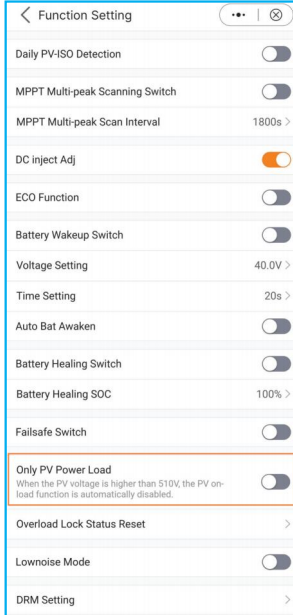

## 5.13 HMI Screen Setting

### 5.13.1 HMI Quick Setting

If this is the first time the inverter has been commissioned, you will need to first go through the Quick Settings. Once this has been done, these settings can be changed later.

**Inverter Time -> Meter Setting -> Grid Code -> Storage mode -> Battery Model**

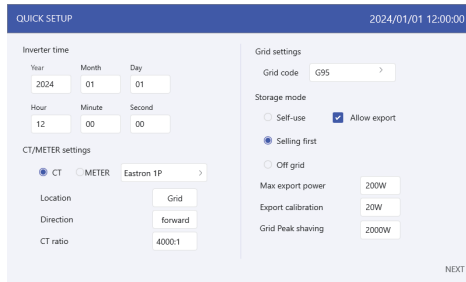

#### 1. Inverter time:

Set inverter time and date, default follow the phone.

#### 2. CT/Meter setting:

Select the CT or Meter, Solis provide Eastron 3 phase meter, it is self-identifiable.

Set installation location: Grid side / Load side / Grid+PV inverter;

CT direction: When CT installed correctly, select "Forward"; when CT installed direction wrong, the sampling current of CT will be reversed when calculating the power, select "Reversal" to correct it.

Set CT ratio: default 3000 (Solis provide ESCT-T50-120A/40mA CT), if the user install their own CT, then need to set the CT ratio manually. If the system connected to Meter, then CT ratio need to be set on Meter.

#### 3. Grid code:

Select grid code that meet the local regulations.

#### 4. Storage mode:

ALL modes first priority is to use the available PV power to support loads. The different modes determine what the second priority, or use of the excess PV power, will be.

Self-use / Selling first / Off-grid are exclusive, the user could select only one mode.

Mode	Description
Self-use	<p>PV power flow priority sequence: loads &gt; battery &gt; grid. In this mode, the system stores excess PV power into the battery after the loads are supplied.</p> <p>If "Allow export" turned on, when the battery is charged full, or there is no battery, the excess PV power will be exported(sold)back to the grid.</p> <p>If the system is set to not export any power, then the inverter will curtail the PV power (derate the inverter output power).</p>
Selling first	<p>PV power flow priority sequence: loads &gt; grid &gt; battery. In this mode, the system exports any excess PV power after the loads are supplied. If the export power quota has been met, then the remaining PV power will be stored in the battery.</p> <p>Notice: This mode should not be used if export power set to zero.</p>
Off grid	<p>PV power flow priority sequence: loads &gt; battery. This mode only used when the system are not electrically connected to the grid at all. This mode is like Self-Use Mode, but the PV power will be curtailed if the PV power output is &gt; battery power + load power</p>

Table 1 Description of modes

Under each mode, user could set other functions based on their requirements.

Settings	Description
Max export power	<p>Default: 1.1 times of rated power. Notice: if feed-in is not allowed, set Max export power to 0.</p>
Export calibration	<p>Range : -500w-500w, default 20w, settable. To compensate the deviation of CT/Meter in practical application.</p>
Grid peak shaving	<p>Default enable, default 2 times of rated power. Limit the power drawn from the grid to prevent from exceeding regulatory requirements or the power line capacity. It works only when the "battery reserve" turned on.</p>

Table 2 Description of mode settings

## 5. Battery setting:

Select battery brand.

Set Max charging/discharging current.

The screenshot displays the 'BATTERY SETTING' configuration screen. At the top, the title 'BATTERY SETTING' and the timestamp '2024/01/01 12:00:00' are visible. The interface is divided into two main sections. The left section, titled 'Batt type', contains a dropdown menu currently set to 'PYLON\_HV' and a list of radio button options: 'Lithium Battery' (selected), '48.0V Lithium Battery (Without COMM)', '51.2V Lithium Battery (Without COMM)', 'Lead-acid Battery', and 'No Battery'. The right section contains several adjustable parameters, each with a corresponding input field: 'Max charge current' (100A), 'Max discharge current' (100A), 'Over discharge' (80%), 'Recovery' (80%), 'Force charge' (80%), and 'Max charge SOC' (80%). At the bottom of this section, there is a checked checkbox for 'Battery saving'. A '1/2' indicator is located in the bottom right corner of the settings panel.

## 5.13.2 HMI screen operation system overview

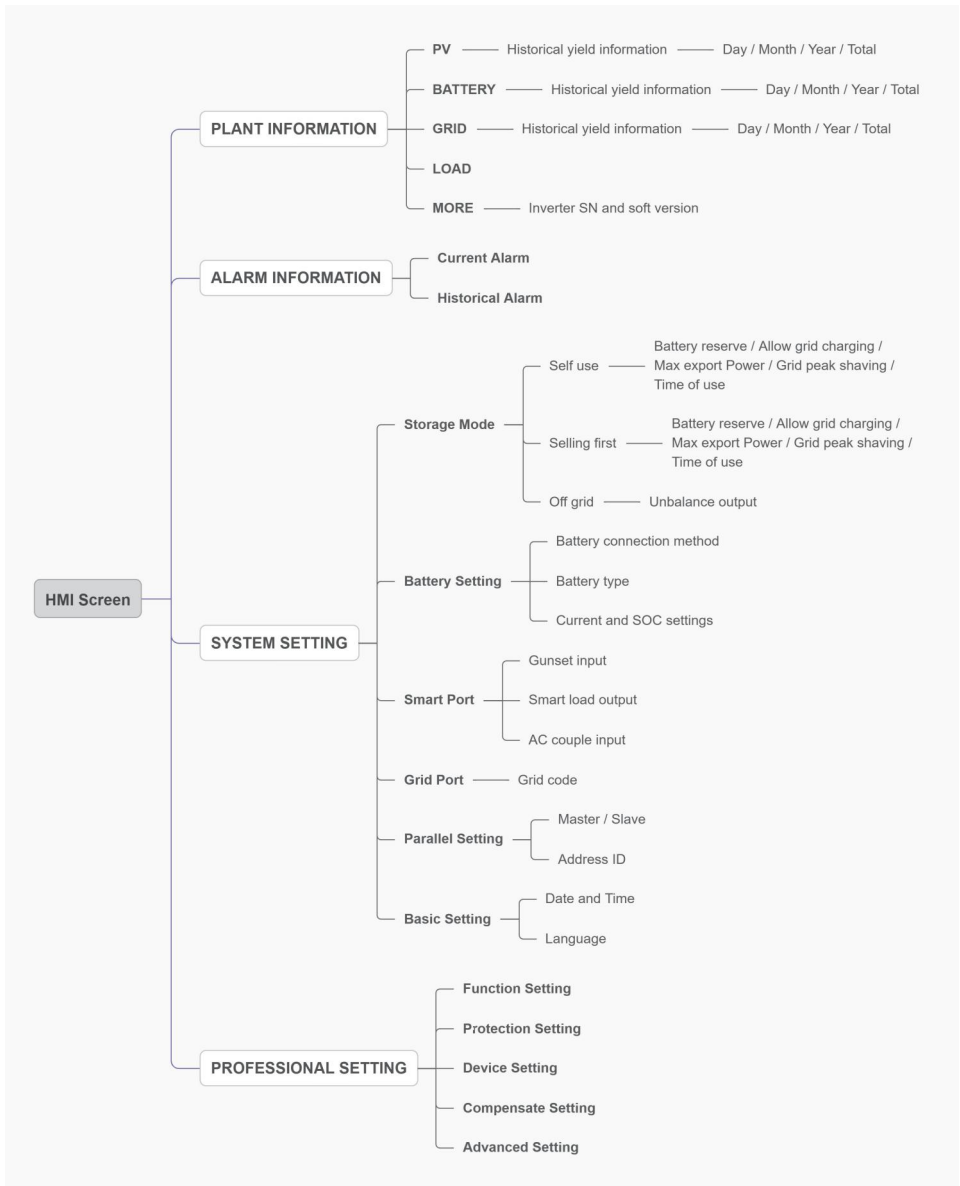



## 5.13.3 Detailed HMI Setting

### Step 1: Enter Home page

After quick setting, press “ENTER”, the screen displays the home page.

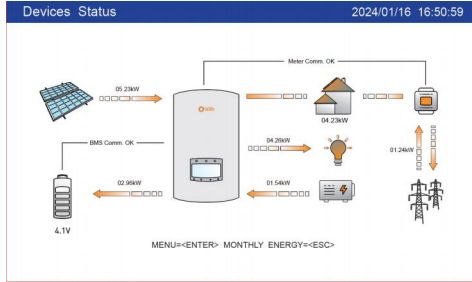

The screen will be automatically turn off after being idle for a few minutes to save power, click any operation button (“ESC”/”UP”/”DOWN”/ “ENTER”) to restart the screen, then press “Enter” into the main operation interface.

### Step 2: Enter “SYSTEM SETTING” interface

Press “Down” button, then press “ENTER” into the “SYSTEM SETTING” interface.

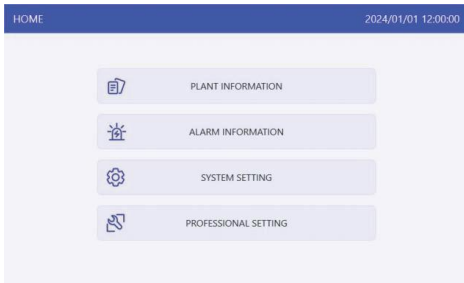

### Step 3: Set “Storage Mode”

Use “UP” or “DOWN” key to select the desired mode, then press “ENTER”.

The Mode description please refer to 5.4.1.

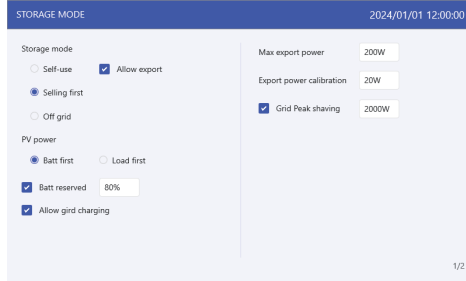

Settings	Description
Battery reserve	Range: 5~95%, default: 80%, settable. When battery SOC < set battery reserve SOC, battery will stop discharging.
Allow grid charging	Allow grid charging the battery when it enables.  Notice: if “Allow Grid Charging” is turned on, the inverter will use grid power to charge the battery only under two circumstances: The battery drains to the Force Charge SOC. When PV power output can’t meet the set current value during the charge periods.
Max export power	Default: 1.1 times of rated power. Notice: if feed-in is not allowed, set Max export power to 0.
Export calibration	Range : -500w-500w, default 20w, settable. To compensate the deviation of CT/Meter in practical application.
Grid peak shaving	Default enable, default 2 times of rated power. Limit the power drawn from the grid to prevent from exceeding regulatory requirements or the power line capacity. It works only when the “battery reserve” turned on.

Table 3 Description of storage mode settings

### Step 4: Set “Time of use” under each mode (Skip this step if no need)

Time of Use is for manual control of the battery charging/discharging. It is for customizing when the battery is allowed to charge and discharge power and at what rate, established by a current(amperage)setting.

1. Charge period: battery charges with set current value until the charging cut-off voltage (settable), checking the box to control whether enable this charging period.
2. Discharge period: battery discharges with set current value until the discharging cut-off voltage (settable), checking the box to control whether enable this discharging period.

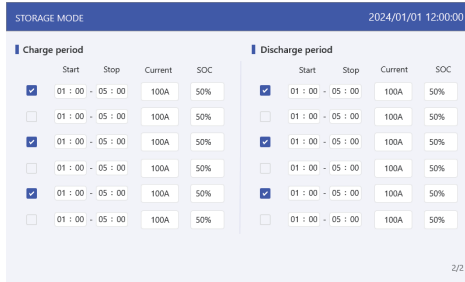

## Step 5: Set “Battery Setting”

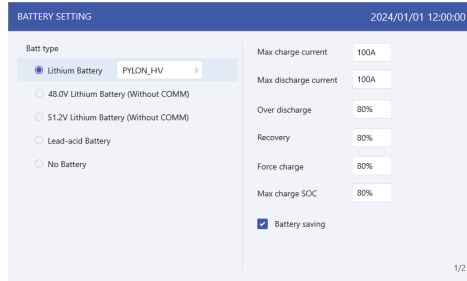

Settings	Description
Max charge current	Max charge current, settable.
Max discharge current	Max discharge current, settable.
Over discharge	Range: 5~40%, default 20%, when battery SOC < over discharge, it will stop discharging.
Recovery	Range: set Over discharge value +1% ~ set Over discharge value +20%; when battery SOC > Recovery SOC, it will start charging, reserve the return difference value to avoid the battery repeatedly cross jump between charging and discharging.
Force charge	Range: set Over discharge value +1% ~ set Over discharge value +20%; when battery SOC > Recovery SOC, it will start charging, reserve the return difference value to avoid the battery repeatedly cross jump between charging and discharging.
Max charge SOC	Charge cut-off SOC, battery stops charging when reach the Max. Charge SOC.

Table 4 Description of battery mode settings



**NOTICE:**

Force charge SOC < Over discharge SOC < Recovery SOC, otherwise the setting might be error.

### Step 6: Set “Grid Port”

(Skip this step if grid code is already set in quick setting)

Select grid code that meet the local regulations.

Three level of Over-voltage / under-voltage / Over-frequency / under-frequency are default based on grid code, there is no need to set the parameters in manual.

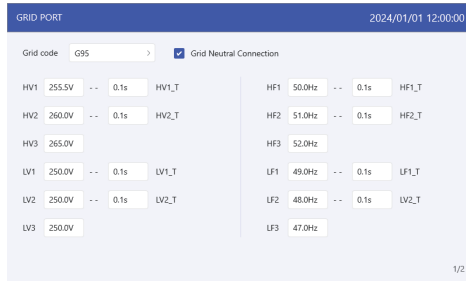

### Step 7: Set “Smart Port”

(Skip this step if the system is not connected to generators)

When it is connected to Generator, select “Gunset input”;

When it is connected to smart load like heat pump, select “Smart load output”

When it is connected to Grid-tied inverter, select “AC coupled”

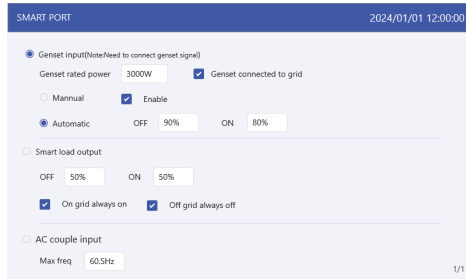

#### Genset

The user need to input the “Genset rated power” by manual.

OFF: Generator stops charging SOC, settable, range:35~100%;

ON: Generator start charging SOC; settable, range:1~95%;

#### AC coupled:

OFF: Grid-tied inverter stops charging SOC, settable, range:35~100%;

ON: Grid-tied inverter start charging SOC; settable, range:1~95%;

### Step 8: Set parallel system

Set Master and Slave machine,

Set Master ID as: 1

Slave machine ID as: 2

.Slave machine ID as: 3

..... and so on.



Solis S6 Series inverter does not require any regular maintenance. However, cleaning the heatsink will help inverter dissipating heat and increase the lifetime of inverter. The dirt on the inverter can be cleaned with a soft brush.



**CAUTION:**

Do not touch the surface when the inverter is operating. Some parts may be hot and cause burns. Turn OFF the inverter and let it cool down before you do any maintenance or cleaning of inverter.

The Intelligent LCD indicators can be cleaned with cloth if they are too dirty.



**NOTE:**

Never use any solvents, abrasives or corrosive materials to clean the inverter.

Message Name	Information Description	Troubleshooting Suggestion
Off	Control device to shutdown	1. Turn on the device in the ON/OFF Setting.
LmtByEPM	The device's output is under controlled	<ol style="list-style-type: none"> <li>1. Confirm whether the inverter is connected to an external EPM/meter to prevent reverse current.</li> <li>2. Confirm whether the inverter is controlled by an external third-party device.</li> <li>3. Confirm whether the power setting of the inverter power control is limited.</li> <li>4. Verify settings in section 6.6.7 and check your meter readings.</li> </ol>
LmtByDRM	DRM Function ON	1. No need to deal with it.
LmtByTemp	Over temperature power limited	1. No need to deal with it, the device is in normal operation.
LmtByFreq	Frequency power limited	
LmtByVg	The device is in the Volt-Watt mode	<ol style="list-style-type: none"> <li>1. Due to the requirements of local safety regulations, when the grid voltage is high, the Volt-watt working mode is triggered, which generally does not need to be dealt with.</li> <li>2. This mode is enabled by default.</li> </ol>
LmtByVar	The device is in the Volt-Var mode of operation	<ol style="list-style-type: none"> <li>1. Due to the requirements of local safety regulations, when the grid voltage is high, the Volt-watt working mode is triggered, which generally does not need to be dealt with.</li> <li>2. This mode is enabled by default.</li> </ol>
LmtByUnFr	Under frequency limit	1. No need to deal with it.
Standby	Bypass run	
StandbySynoch	Off grid status to On grid status	
GridToLoad	Grid to load	



Message Name	Information Description	Troubleshooting Suggestion
Surge Alarm	On-site grid surge	1. Grid side fault, restart the device. If it is still not eliminated, please contact the manufacturer's customer service.
OV-G-V01	Grid voltage exceeds the upper voltage range	1. Confirm whether the power grid is abnormal. 2. Confirm that the AC cable is properly connected. 3. Restart the system and check if the fault persists.
UN-G-V01	Grid voltage exceeds the lower voltage range	
OV-G-F01	Grid frequency exceeds the upper frequency range	
UN-G-F01	Grid frequency exceeds the lower frequency range	
G-PHASE	Unbalanced grid voltage	
G-F-GLU	Grid voltage frequency fluctuation	
NO-Grid	No grid	
OV-G-V02	Grid transient overvoltage	
OV-G-V03	Grid transient overvoltage	1. Restart the system, confirm if that the fault continues.
IGFOL-F	Grid current tracking failure	1. Confirm whether the power grid is abnormal. 2. Confirm that the AC cable is properly connected. 3. Restart the system and check if the fault persists.
OV-G-V05	Grid voltage RMS instantaneous overvoltage fault	
OV-G-V04	Grid voltage exceeds the upper voltage range	
UN-G-V02	Grid voltage exceeds the lower voltage range	
OV-G-F02	Grid frequency exceeds the upper frequency range	
UN-G-F02	Grid frequency exceeds the lower frequency range	
NO-Battery	Battery is not connected	1. Check on information page 1 – Verify the battery voltage is within standards. 2. Measure battery voltage at plug.
OV-Vbackup	Inverting overvoltage	1. Check whether the backup port wiring is normal 2. Restart the system, confirm that the fault continues.
Over-Load	Load overload fault	1. Backup load power is too large, or some inductive load startup power is too large, need to remove some backup load, or remove the inductive load on the backup.

Message Name	Information Description	Troubleshooting Suggestion
BatName-FAIL	Wrong battery brand selection	1. Confirm whether the battery model selection is consistent with the actual one.
CAN Fail	CAN Fail	1. Can failure is a failure of communication between inverter and battery. Check cable conditions. Check to ensure you have it plugged in on the CAN port of the battery and inverter. Check that you are using the right cable. Some batteries require a special battery from the battery manufacturer.
OV-Vbatt	Battery overvoltage detected	1. Verify battery voltage is within standards. Measure battery voltage at inverter connection point. Contact your battery manufacturer for further service.
UN-Vbatt	Battery undervoltage detected	1. Restart the system and check if the fault persists. If it is still not eliminated, please contact the manufacturer's customer service.
Fan Alarm	Fan alarm	1. Check if the internal fan is working correctly or jammed.
OV-DC01 (1020 DATA:0001)	DC 1 input overvoltage	1. Check if the PV voltage is abnormal 2. Restart the system, confirm that the fault continues
OV-DC02 (1020 DATA:0002)	DC 2 input overvoltage	
OV-BUS (1021 DATA:0000)	DC bus overvoltage	1. Restart the system, confirm that the fault continues.
UN-BUS01 (1023 DATA:0001)	DC bus undervoltage	
UNB-BUS (1022 DATA:0000)	DC bus unbalanced voltage	
UN-BUS02 (1023 DATA:0002)	Abnormal detection of DC bus voltage	
DC-INTF. (1027 DATA:0000)	DC hardware overcurrent (1, 2, 3, 4)	1. Check if the DC wires are connected correctly without loose connection.
OV-G-I (1018 DATA:0000)	Aphase RMS value overcurrent	1. Confirm that the grid is abnormal. 2. Confirm that the AC cable connection is not abnormal. 3. Restart the system, confirm that the fault continues.
OV-DCA-I (1025 DATA:0000)	DC 1 average overcurrent	1. Restart the system, confirm that the fault continues.
OV-DCB-I (1026 DATA:0000)	DC 2 average overcurrent	
GRID-INTF. (1030 DATA:0000)	AC hardware overcurrent (abc phase)	

Message Name	Information Description	Troubleshooting Suggestion
DCInj-FAULT (1037 DATA:0000)	The current DC component exceeds the limit	<ol style="list-style-type: none"> <li>1. Confirm that the grid is abnormal.</li> <li>2. Confirm that the AC cable connection is not abnormal.</li> <li>3. Restart the system, confirm that the fault continues.</li> </ol>
IGBT-OV-I (1048 DATA:0000)	IGBT overcurrent	<ol style="list-style-type: none"> <li>1. Restart the system, confirm that the fault continues.</li> </ol>
OV-TEM (1032 DATA:0000)	Module over temperature	<ol style="list-style-type: none"> <li>1. Check whether the surrounding environment of the inverter has poor heat dissipation.</li> <li>2. Confirm whether the product installation meets the requirements.</li> </ol>
RelayChk-FAIL (1035 DATA:0000)	Relay failure	<ol style="list-style-type: none"> <li>1. Restart the system, confirm that the fault continues.</li> </ol>
UN-TEM (103A DATA:0000)	Low temperature protection	<ol style="list-style-type: none"> <li>1. Check the working environment temperature of the inverter.</li> <li>2. Restart the system to confirm if the fault continues.</li> </ol>
PV ISO-PRO01 (1033 DATA:0001)	PV negative ground fault	<ol style="list-style-type: none"> <li>1. Check whether the PV strings have insulation problems.</li> <li>2. Check whether the PV cable is damaged.</li> </ol>
PV ISO-PRO02 (1033 DATA:0002)	PV positive ground fault	
12Power-FAULT (1038 DATA:0000)	12V undervoltage failure	<ol style="list-style-type: none"> <li>1. Check current leakage to ground. Verify your grounding. Verify all wires are in good condition and not leaking current to ground.</li> </ol>
ILeak-PRO01 (1034 DATA:0001)	Leakage current failure 01 (30mA)	
ILeak-PRO02 (1034 DATA:0002)	Leakage current failure 02 (60mA)	
ILeak-PRO03 (1034 DATA:0003)	Leakage current failure 03 (150mA)	
ILeak-PRO04 (1034 DATA:0004)	Leakage current failure 04	
ILeak_Check (1039 DATA:0000)	Leakage current sensor failure	
GRID-INTF02 (1046 DATA:0000)	Power grid disturbance 02	<ol style="list-style-type: none"> <li>1. Confirm whether the grid is seriously distorted.</li> <li>2. Check whether the AC cable is connected reliably.</li> </ol>
OV-Vbatt-H/ OV-BUS-H (1051 DATA:0000)	Battery overvoltage hardware failure / VBUS	<ol style="list-style-type: none"> <li>1. Check if the battery circuit breaker is tripping.</li> <li>2. Check if the battery is damaged.</li> </ol>

Message Name	Information Description	Troubleshooting Suggestion
OV-ILLC (1052 DATA:0000)	LLC hardware overcurrent	1. Check whether the backup load is overloaded. 2. Restart the system, confirm that the fault continues.
INI-FAULT (1031 DATA:0000)	AD zero drift overlink	1. Restart the system, confirm that the fault continues.
DSP-B-FAULT (1036 DATA:0000)	The master-slave DSP communication is abnormal	
AFCI-Check (1040 DATA:0000)	AFCI self-test failure	
ARC- FAULT (1041 DATA:0000)	AFCI failure	1. Verify connections are tight within your PV system. Arc fault settings can be changed in advanced settings if further adjustment is necessary.

Table 7.1 Fault message and description



**NOTE:**

If the inverter displays any alarm message as listed in Table 7.1; please turn off the inverter and wait for 5 minutes before restarting it .  
If the failure persists, please contact your local distributor or the service center.

Please keep ready with you the following information before contacting us.

1. Serial number of Solis three phase inverter;
2. The distributor/dealer of Solis three phase inverter (if available);
3. Installation date.
4. The description of the problem together with necessary information, pictures, attachment.
5. The PV array configuration (e.g. number of panels, capacity of panels, number of strings, etc.);
6. Battery details (brand, model, capacity, data connection, etc.).
7. Your contact details.

# 8. Specifications

Technical Data	S6-EH3P12K-H
<b>Input DC (PV side)</b>	
Max Usable PV Input Power	19200W
Max. input voltage	1000V
Rated voltage	600V
Start-up voltage	160V
MPPT voltage range	200-850V
Full load MPPT voltage range	300-850V
Max. input current	4*20A
Max. short circuit current	4*30A
MPPT number/Max input strings number	4/4
<b>Battery</b>	
Battery Type	Li-ion
Battery Voltage range	120 - 800Vdc
Maximum charging Power	12kW
Maximum Charge/discharge current	50A
Communication	CAN/RS485
<b>Output AC(Grid-side)</b>	
Rated output power	12kW
Max. apparent output power	12kVA
Rated grid voltage	3/N/PE, 220V/380V, 230V/400V
The grid voltage range	320-460V
Rating grid frequency	50 Hz/60 Hz
AC grid frequency range	45-55 Hz/ 55-65Hz
Rating grid output current	18.2A/17.3A
Max. output current	18.2A/17.3A
Power factor	> 0.99 ( 0.8 leading to 0.8 lagging)
THDi	< 3%
<b>Input AC(Grid-side)</b>	
Max. input power	18kW
Rated input current	27.3A/26.0A
Rated input voltage	3/N/PE, 220V/380V, 230V/400V
Rated input frequency	50 Hz/60 Hz

# 8. Specifications

Technical Data	S6-EH3P12K-H
<b>Input Generator</b>	
Max. input power	12kW
Rated input current	18.2A/17.3A
Rated input frequency	50 Hz/60 Hz
<b>Output AC(Back-up)</b>	
Rated output power	12kW
Peak apparent output power	2 time of rated power, 10 S
Back-up switch time	< 10ms
Rated output voltage	3/N/PE, 220V/380V, 230V/400V
Rated frequency	50 Hz/60 Hz
Rated output current	18.2A/17.3A
THDv(@linear load)	<3%
<b>Efficiency</b>	
Max. efficiency	97.70%
EU efficiency	97.50%
BAT charged by PV Max. efficiency	98.50%
BAT charged/discharged to AC Max. efficiency	97.20%
MPPT efficiency	99.90%
<b>Protection</b>	
Anti-islanding protection	Yes
Output over voltage protection	Yes
Insulation resistance monitoring	Yes
Residual current detection	Yes
Output over current protection	Yes
Short circuit protection	Yes
Integrated AFCI 2.0	Optional
Integrated DC switch	Yes
DC reverse polarity protection	Yes
PV overvoltage protection	Yes
Battery reverse protection	Yes

# 8. Specifications

Technical Data	S6-EH3P12K-H
<b>General data</b>	
Max. allowable phase imbalance (grid & back up)	100%
Max. power per phase (grid & back up)	50% rated power
Dimensions(W/H/D)	563*546*250mm
Weight	35.2kg
Topology	Transformerless
Self consumption (Night)	<25 W
Operation temperature range	-25°C ~ +60°C
Relative humidity	0-95%
Ingress protection	IP66
Noise emission (typical)	<65 dB(A)
Cooling concept	Smart cooling
Max.operation altitude	2000m
Grid connection standard	EN 50549-1, VDE4105 CEI 0-21, CEI 0-16, NC-RFG TypeB, NRS 097-2-1 ED 2.1
Safety/EMC standard	IEC/EN 62109-1/-2, IEC/EN 61000-6-1/-3, IEC 61000-2
<b>Features</b>	
PV connection	MC4 connector
Battery connection	OT terminal
AC connection	OT terminal
Display	7.0" LCD display & Bluetooth+APP
Communication	CAN, RS485, Ethernet, optional:Wi-Fi, Cellular, LAN
Warranty	5 years (extendable to 20 years)

# 8. Specifications

Technical Data	S6-EH3P15K-H
<b>Input DC (PV side)</b>	
Max Usable PV Input Power	24000W
Max. input voltage	1000V
Rated voltage	600V
Start-up voltage	160V
MPPT voltage range	200-850V
Full load MPPT voltage range	300-850V
Max. input current	4*20A
Max. short circuit current	4*30A
MPPT number/Max input strings number	4/4
<b>Battery</b>	
Battery Type	Li-ion
Battery Voltage range	120 - 800Vdc
Maximum charging Power	15kW
Maximum Charge/discharge current	50A
Communication	CAN/RS485
<b>Output AC(Grid-side)</b>	
Rated output power	15kW
Max. apparent output power	15kVA
Rated grid voltage	3/N/PE, 220V/380V, 230V/400V
The grid voltage range	320-460V
Rating grid frequency	50 Hz/60 Hz
AC grid frequency range	45-55 Hz/ 55-65Hz
Rating grid output current	22.8A/21.7A
Max. output current	22.8A/21.7A
Power factor	> 0.99 ( 0.8 leading to 0.8 lagging)
THDi	< 3%
<b>Input AC(Grid-side)</b>	
Max. input power	22.5kW
Rated input current	34.2A/32.5A
Rated input voltage	3/N/PE, 220V/380V, 230V/400V
Rated input frequency	50 Hz/60 Hz



# 8. Specifications

Technical Data	S6-EH3P15K-H
<b>Input Generator</b>	
Max. input power	15kW
Rated input current	22.8A/21.7A
Rated input frequency	50 Hz/60 Hz
<b>Output AC(Back-up)</b>	
Rated output power	15kW
Peak apparent output power	2 time of rated power, 10 S
Back-up switch time	< 10ms
Rated output voltage	3/N/PE, 220V/380V, 230V/400V
Rated frequency	50 Hz/60 Hz
Rated output current	22.8A/21.7A
THDv(@linear load)	<3%
<b>Efficiency</b>	
Max. efficiency	97.70%
EU efficiency	97.50%
BAT charged by PV Max. efficiency	98.50%
BAT charged/discharged to AC Max. efficiency	97.20%
MPPT efficiency	99.90%
<b>Protection</b>	
Anti-islanding protection	Yes
Output over voltage protection	Yes
Insulation resistance monitoring	Yes
Residual current detection	Yes
Output over current protection	Yes
Short circuit protection	Yes
Integrated AFCI 2.0	Optional
Integrated DC switch	Yes
DC reverse polarity protection	Yes
PV overvoltage protection	Yes
Battery reverse protection	Yes

# 8. Specifications

Technical Data	S6-EH3P15K-H
<b>General data</b>	
Max. allowable phase imbalance (grid & back up)	100%
Max. power per phase (grid & back up)	50% rated power
Dimensions(W/H/D)	563*546*250mm
Weight	35.2kg
Topology	Transformerless
Self consumption (Night)	<25 W
Operation temperature range	-25°C ~ +60°C
Relative humidity	0-95%
Ingress protection	IP66
Noise emission (typical)	<65 dB(A)
Cooling concept	Smart cooling
Max.operation altitude	2000m
Grid connection standard	EN 50549-1, VDE4105 CEI 0-21, CEI 0-16, NC-RFG TypeB, NRS 097-2-1 ED 2.1
Safety/EMC standard	IEC/EN 62109-1/-2, IEC/EN 61000-6-1/-3, IEC 61000-2
<b>Features</b>	
PV connection	MC4 connector
Battery connection	OT terminal
AC connection	OT terminal
Display	7.0" LCD display & Bluetooth+APP
Communication	CAN, RS485, Ethernet, optional:Wi-Fi, Cellular, LAN
Warranty	5 years (extendable to 20 years)

# 8. Specifications

Technical Data	S6-EH3P20K-H
<b>Input DC (PV side)</b>	
Max Usable PV Input Power	32000W
Max. input voltage	1000V
Rated voltage	600V
Start-up voltage	160V
MPPT voltage range	200-850V
Full load MPPT voltage range	300-850V
Max. input current	4*20A
Max. short circuit current	4*30A
MPPT number/Max input strings number	4/4
<b>Battery</b>	
Battery Type	Li-ion
Battery Voltage range	120 - 800Vdc
Maximum charging Power	20kW
Maximum Charge/discharge current	50A
Communication	CAN/RS485
<b>Output AC(Grid-side)</b>	
Rated output power	20kW
Max. apparent output power	20kVA
Rated grid voltage	3/N/PE, 220V/380V, 230V/400V
The grid voltage range	320-460V
Rating grid frequency	50 Hz/60 Hz
AC grid frequency range	45-55 Hz/ 55-65Hz
Rating grid output current	30.4A/28.9A
Max. output current	30.4A/28.9A
Power factor	> 0.99 ( 0.8 leading to 0.8 lagging)
THDi	< 3%
<b>Input AC(Grid-side)</b>	
Max. input power	30kW
Rated input current	45.6A/43.3A
Rated input voltage	3/N/PE, 220V/380V, 230V/400V
Rated input frequency	50 Hz/60 Hz

# 8. Specifications

Technical Data	S6-EH3P20K-H
<b>Input Generator</b>	
Max. input power	20kW
Rated input current	30.4A/28.9A
Rated input frequency	50 Hz/60 Hz
<b>Output AC(Back-up)</b>	
Rated output power	20kW
Peak apparent output power	1.6 time of rated power, 10 S
Back-up switch time	< 10ms
Rated output voltage	3/N/PE, 220V/380V, 230V/400V
Rated frequency	50 Hz/60 Hz
Rated output current	30.4A/28.9A
THDv(@linear load)	<3%
<b>Efficiency</b>	
Max. efficiency	97.70%
EU efficiency	97.50%
BAT charged by PV Max. efficiency	98.50%
BAT charged/discharged to AC Max. efficiency	97.20%
MPPT efficiency	99.90%
<b>Protection</b>	
Anti-islanding protection	Yes
Output over voltage protection	Yes
Insulation resistance monitoring	Yes
Residual current detection	Yes
Output over current protection	Yes
Short circuit protection	Yes
Integrated AFCI 2.0	Optional
Integrated DC switch	Yes
DC reverse polarity protection	Yes
PV overvoltage protection	Yes
Battery reverse protection	Yes

# 8. Specifications

Technical Data	S6-EH3P20K-H
<b>General data</b>	
Max. allowable phase imbalance (grid & back up)	100%
Max. power per phase (grid & back up)	40% rated power
Dimensions(W/H/D)	563*546*250mm
Weight	35.2kg
Topology	Transformerless
Self consumption (Night)	<25 W
Operation temperature range	-25°C ~ +60°C
Relative humidity	0-95%
Ingress protection	IP66
Noise emission (typical)	<65 dB(A)
Cooling concept	Smart cooling
Max.operation altitude	2000m
Grid connection standard	EN 50549-1, VDE4105 CEI 0-21, CEI 0-16, NC-RFG TypeB, NRS 097-2-1 ED 2.1
Safety/EMC standard	IEC/EN 62109-1/-2, IEC/EN 61000-6-1/-3, IEC 61000-2
<b>Features</b>	
PV connection	MC4 connector
Battery connection	OT terminal
AC connection	OT terminal
Display	7.0" LCD display & Bluetooth+APP
Communication	CAN, RS485, Ethernet, optional:Wi-Fi, Cellular, LAN
Warranty	5 years (extendable to 20 years)

# 8. Specifications

Technical Data	S6-EH3P8K-LV-H
<b>Input DC (PV side)</b>	
Max Usable PV Input Power	12800W
Max. input voltage	1000V
Rated voltage	600V
Start-up voltage	160V
MPPT voltage range	200-850V
Full load MPPT voltage range	300-850V
Max. input current	4*16A
Max. short circuit current	4*24A
MPPT number/Max input strings number	4/4
<b>Battery</b>	
Battery Type	Li-ion
Battery Voltage range	120 - 800Vdc
Maximum charging Power	8kW
Maximum Charge/discharge current	50A
Communication	CAN/RS485
<b>Output AC(Grid-side)</b>	
Rated output power	8kW
Max. apparent output power	8kVA
Rated grid voltage	3/(N)/PE, 127V/220V, 133V/230V
The grid voltage range	195-265V
Rating grid frequency	50 Hz/60 Hz
AC grid frequency range	45-55 Hz/ 55-65Hz
Rating grid output current	20.1A
Max. output current	20.1A
Power factor	> 0.99 ( 0.8 leading to 0.8 lagging)
THDi	< 3%
<b>Input AC(Grid-side)</b>	
Max. input power	12kW
Rated input current	30.1A
Rated input voltage	3/(N)/PE, 127V/220V, 133V/230V
Rated input frequency	50 Hz/60 Hz

# 8. Specifications

Technical Data	S6-EH3P8K-LV-H
<b>Input Generator</b>	
Max. input power	8kW
Rated input current	20.1A
Rated input frequency	50 Hz/60 Hz
<b>Output AC(Back-up)</b>	
Rated output power	8kW
Peak apparent output power	2 time of rated power, 10 S
Back-up switch time	< 10ms
Rated output voltage	3/(N)/PE, 127V/220V, 133V/230V
Rated frequency	50 Hz/60 Hz
Rated output current	20.1A
THDv(@linear load)	<2%
<b>Efficiency</b>	
Max. efficiency	97.70%
EU efficiency	97.50%
BAT charged by PV Max. efficiency	98.50%
BAT charged/discharged to AC Max. efficiency	97.20%
MPPT efficiency	99.90%
<b>Protection</b>	
Anti-islanding protection	Yes
Output over voltage protection	Yes
Insulation resistance monitoring	Yes
Residual current detection	Yes
Output over current protection	Yes
Short circuit protection	Yes
Integrated AFCI 2.0	Optional
Integrated DC switch	Yes
DC reverse polarity protection	Yes
PV overvoltage protection	Yes
Battery reverse protection	Yes

# 8. Specifications

Technical Data	S6-EH3P8K-LV-H
<b>General data</b>	
Max. allowable phase imbalance (grid & back up)	100%
Max. power per phase (grid & back up)	50% rated power
Dimensions(W/H/D)	563*546*250mm
Weight	35.2kg
Topology	Transformerless
Self consumption (Night)	<25 W
Operation temperature range	-25°C ~ +60°C
Relative humidity	0-95%
Ingress protection	IP66
Noise emission (typical)	<65 dB(A)
Cooling concept	Smart cooling
Max.operation altitude	2000m
Grid connection standard	VDE4105, REN342, EN5049, C10/11
Safety/EMC standard	IEC/EN 62109-1/-2, IEC/EN 61000-6-1/-3
<b>Features</b>	
PV connection	MC4 connector
Battery connection	Latched type plug
AC connection	Latched type plug
Display	7.0" LCD display & Bluetooth+APP
Communication	CAN, RS485, Ethernet, optional:Wi-Fi, Cellular, LAN
Warranty	5 years (extendable to 20 years)



# 8. Specifications

Technical Data	S6-EH3P10K-LV-H
<b>Input DC (PV side)</b>	
Max Usable PV Input Power	16000W
Max. input voltage	1000V
Rated voltage	600V
Start-up voltage	160V
MPPT voltage range	200-850V
Full load MPPT voltage range	300-850V
Max. input current	4*16A
Max. short circuit current	4*24A
MPPT number/Max input strings number	4/4
<b>Battery</b>	
Battery Type	Li-ion
Battery Voltage range	120 - 800Vdc
Maximum charging Power	10kW
Maximum Charge/discharge current	50A
Communication	CAN/RS485
<b>Output AC(Grid-side)</b>	
Rated output power	10kW
Max. apparent output power	10kVA
Rated grid voltage	3/(N)/PE, 127V/220V, 133V/230V
The grid voltage range	195-265V
Rating grid frequency	50 Hz/60 Hz
AC grid frequency range	45-55 Hz/ 55-65Hz
Rating grid output current	25.1A
Max. output current	25.1A
Power factor	> 0.99 ( 0.8 leading to 0.8 lagging)
THDi	< 3%
<b>Input AC(Grid-side)</b>	
Max. input power	15kW
Rated input current	37.7A
Rated input voltage	3/(N)/PE, 127V/220V, 133V/230V
Rated input frequency	50 Hz/60 Hz

# 8. Specifications

Technical Data	S6-EH3P10K-LV-H
<b>Input Generator</b>	
Max. input power	10kW
Rated input current	25.1A
Rated input frequency	50 Hz/60 Hz
<b>Output AC(Back-up)</b>	
Rated output power	10kW
Peak apparent output power	2 time of rated power, 10 S
Back-up switch time	< 10ms
Rated output voltage	3/(N)/PE, 127V/220V, 133V/230V
Rated frequency	50 Hz/60 Hz
Rated output current	25.1A
THDv(@linear load)	<2%
<b>Efficiency</b>	
Max. efficiency	97.70%
EU efficiency	97.50%
BAT charged by PV Max. efficiency	98.50%
BAT charged/discharged to AC Max. efficiency	97.20%
MPPT efficiency	99.90%
<b>Protection</b>	
Anti-islanding protection	Yes
Output over voltage protection	Yes
Insulation resistance monitoring	Yes
Residual current detection	Yes
Output over current protection	Yes
Short circuit protection	Yes
Integrated AFCI 2.0	Optional
Integrated DC switch	Yes
DC reverse polarity protection	Yes
PV overvoltage protection	Yes
Battery reverse protection	Yes

# 8. Specifications

Technical Data	S6-EH3P10K-LV-H
<b>General data</b>	
Max. allowable phase imbalance (grid & back up)	100%
Max. power per phase (grid & back up)	50% rated power
Dimensions(W/H/D)	563*546*250mm
Weight	35.2kg
Topology	Transformerless
Self consumption (Night)	<25 W
Operation temperature range	-25°C ~ +60°C
Relative humidity	0-95%
Ingress protection	IP66
Noise emission (typical)	<65 dB(A)
Cooling concept	Smart cooling
Max.operation altitude	2000m
Grid connection standard	VDE4105, REN342, EN5049, C10/11
Safety/EMC standard	IEC/EN 62109-1/-2, IEC/EN 61000-6-1/-3
<b>Features</b>	
PV connection	MC4 connector
Battery connection	Latched type plug
AC connection	Latched type plug
Display	7.0" LCD display & Bluetooth+APP
Communication	CAN, RS485, Ethernet, optional:Wi-Fi, Cellular, LAN
Warranty	5 years (extendable to 20 years)

# 8. Specifications

Technical Data	S6-EH3P12K-LV-H
<b>Input DC (PV side)</b>	
Max Usable PV Input Power	19200W
Max. input voltage	1000V
Rated voltage	600V
Start-up voltage	160V
MPPT voltage range	200-850V
Full load MPPT voltage range	300-850V
Max. input current	4*20A
Max. short circuit current	4*30A
MPPT number/Max input strings number	4/4
<b>Battery</b>	
Battery Type	Li-ion
Battery Voltage range	120 - 800Vdc
Maximum charging Power	12kW
Maximum Charge/discharge current	50A
Communication	CAN/RS485
<b>Output AC(Grid-side)</b>	
Rated output power	12kW
Max. apparent output power	12kVA
Rated grid voltage	3/(N)/PE, 127V/220V, 133V/230V
The grid voltage range	195-265V
Rating grid frequency	50 Hz/60 Hz
AC grid frequency range	45-55 Hz/ 55-65Hz
Rating grid output current	30.1A
Max. output current	30.1A
Power factor	> 0.99 ( 0.8 leading to 0.8 lagging)
THDi	< 3%
<b>Input AC(Grid-side)</b>	
Max. input power	18kW
Rated input current	45.2A
Rated input voltage	3/(N)/PE, 127V/220V, 133V/230V
Rated input frequency	50 Hz/60 Hz

# 8. Specifications

Technical Data	S6-EH3P12K-LV-H
<b>Input Generator</b>	
Max. input power	12kW
Rated input current	30.1A
Rated input frequency	50 Hz/60 Hz
<b>Output AC(Back-up)</b>	
Rated output power	12kW
Peak apparent output power	1.6 time of rated power, 10 S
Back-up switch time	< 10ms
Rated output voltage	3/(N)/PE, 127V/220V, 133V/230V
Rated frequency	50 Hz/60 Hz
Rated output current	30.1A
THDv(@linear load)	<2%
<b>Efficiency</b>	
Max. efficiency	97.70%
EU efficiency	97.50%
BAT charged by PV Max. efficiency	98.50%
BAT charged/discharged to AC Max. efficiency	97.20%
MPPT efficiency	99.90%
<b>Protection</b>	
Anti-islanding protection	Yes
Output over voltage protection	Yes
Insulation resistance monitoring	Yes
Residual current detection	Yes
Output over current protection	Yes
Short circuit protection	Yes
Integrated AFCI 2.0	Optional
Integrated DC switch	Yes
DC reverse polarity protection	Yes
PV overvoltage protection	Yes
Battery reverse protection	Yes

# 8. Specifications

Technical Data	S6-EH3P12K-LV-H
<b>General data</b>	
Max. allowable phase imbalance (grid & back up)	100%
Max. power per phase (grid & back up)	40% rated power
Dimensions(W/H/D)	563*546*250mm
Weight	35.2kg
Topology	Transformerless
Self consumption (Night)	<25 W
Operation temperature range	-25°C ~ +60°C
Relative humidity	0-95%
Ingress protection	IP66
Noise emission (typical)	<65 dB(A)
Cooling concept	Smart cooling
Max.operation altitude	2000m
Grid connection standard	VDE4105, REN342, EN5049, C10/11
Safety/EMC standard	IEC/EN 62109-1/-2, IEC/EN 61000-6-1/-3
<b>Features</b>	
PV connection	MC4 connector
Battery connection	Latched type plug
AC connection	Latched type plug
Display	7.0" LCD display & Bluetooth+APP
Communication	CAN, RS485, Ethernet, optional:Wi-Fi, Cellular, LAN
Warranty	5 years (extendable to 20 years)

Ginlong Technologies Co., Ltd.

No. 57 Jintong Road, Binhai Industrial Park, Xiangshan, Ningbo,  
Zhejiang, 315712, P.R.China.

Tel: +86 (0)574 6578 1806

Email: [info@ginlong.com](mailto:info@ginlong.com)

Web: [www.solisinverters.com](http://www.solisinverters.com)

Please adhere to the actual products in case of any discrepancies in this user manual.

If you encounter any problem on the inverter, please find out the inverter S/N and contact us, we will try to respond to your question ASAP.