



# User Manual

for S6 Series Hybrid Inverter



## Applicable models

S6-EH3P12K-ND-H

S6-EH3P15K-ND-H

S6-EH3P20K-ND-H

S6-EH3P8K-LV-ND-H

S6-EH3P10K-LV-ND-H

S6-EH3P12K-LV-ND-H

## Applicable System

Three phase system

---

<b>1. Introduction</b>	02
1.1 Product Description	02
1.2 Packaging	03
1.3 Inverter Circuit Diagram	04
1.4 Tools Required for Installation	04
<b>2. Safety &amp; Warning</b>	05
2.1 Safety	05
2.2 General Safety Instructions	05
2.3 Notice For Use	07
2.4 Notice for Disposal	07
<b>3. Overview</b>	08
3.1 Screen	08
3.2 Keypad	08
3.3 LCD Indicators	08
3.4 System Description	09
<b>4. Installation</b>	16
4.1 Select a Location for the Inverter	16
4.2 Mounting the Inverter	18
4.3 PE Cable Installation	19
4.4 PV Input Cable Installation	20
4.5 Battery Cable Installation	23
4.6 AC Wiring	24
4.7 CT Connection	25
4.8 Inverter Communication	26
4.9 Inverter Remote Monitoring Connection	33
<b>5. Commissioning &amp; Shutdown</b>	34
5.1 Preparation of Commissioning	34
5.2 Commissioning Procedure	34
5.3 Quick Settings	35
5.4 Shutdown procedure	37
5.5 Work Mode and Settings	38
5.6 TOU Function Settings	43
5.7 Battery Settings	44
5.8 Battery Healing Switch	46
5.9 Battery Reserve Function Settings	47
5.10 Feed in power limit function	48
5.11 Parallel Settings	50
5.12 Smart port settings	51
5.13 CT Detection function	53
5.14 Only PV power load function	53
<b>6. Maintenance</b>	55
<b>7. Troubleshooting</b>	56
<b>8. Specifications</b>	61

## 1.1 Product Description

The Solis S6 Series is designed for residential hybrid systems, which can work with batteries to optimize self-consumption. The unit can operate in both off- and on-grid modes.

This manual covers the Solis S6 Series inverter model listed below:

S6-EH3P12K-ND-H, S6-EH3P15K-ND-H, S6-EH3P20K-ND-H, S6-EH3P8K-LV-ND-H, S6-EH3P10K-LV-ND-H, S6-EH3P12K-LV-ND-H

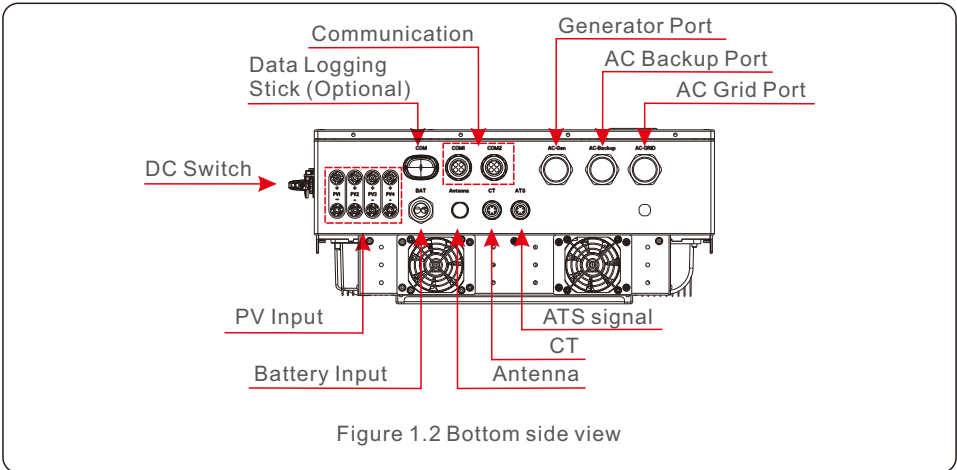
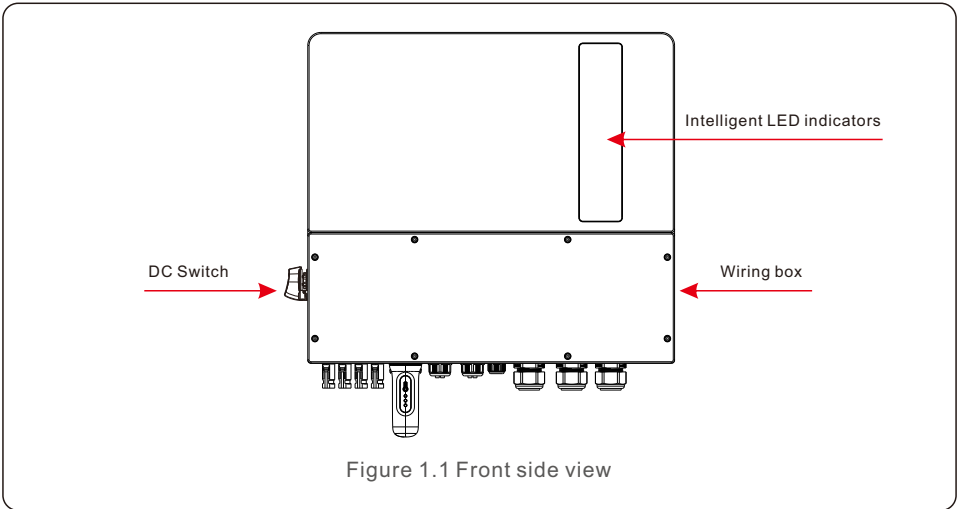

## 1.2 Packaging

Please ensure that the following items are included in the packaging with your machine:

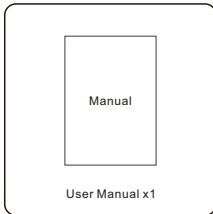
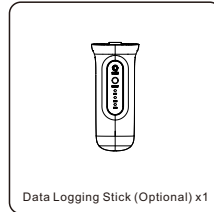
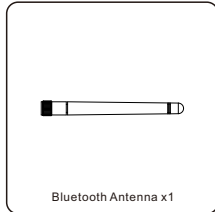
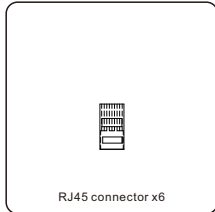
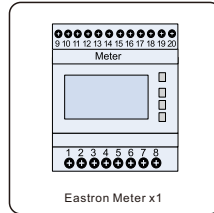
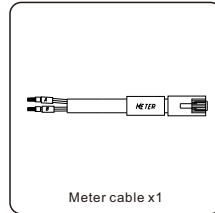
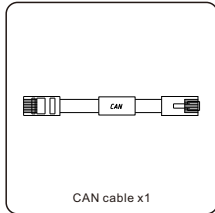
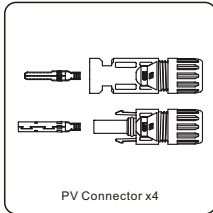
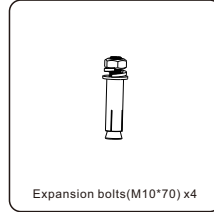
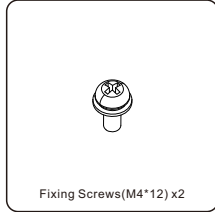
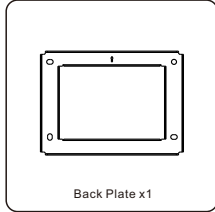
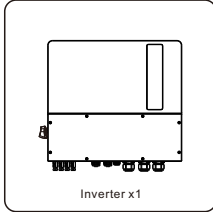

 **NOTE:** If customer purchases the CT configuration scheme, the attachment only contains CT.  
If the meter configuration plan is purchased, the accessories include CT, the meter, and the meter communication cable.

If anything is missing, please contact your local Solis distributor.

## 1.3 Inverter Circuit Diagram

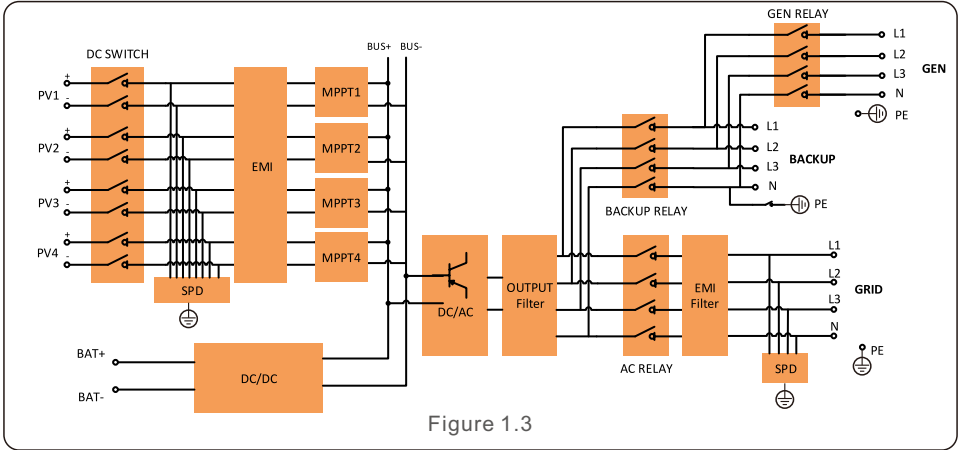

## 1.4 Tools Required for Installation



## 2.1 Safety

The following types of safety instructions and general information appear in this document as described below:



**DANGER:**

“Danger” indicates a hazardous situation which if not avoided, will result in death or serious injury.



**WARNING:**

“Warning” indicates a hazardous situation which if not avoided, could result in death or serious injury.



**CAUTION:**

“Caution” indicates a hazardous situation which if not avoided, could result in minor or moderate injury.



**NOTE:**

“Note” provides tips that are valuable for the optimal operation of your product.



**WARNING: Risk of fire**

Despite careful construction, electrical devices can cause fires.

- Do not install the inverter in areas containing highly flammable materials or gases.
- Do not install the inverter in potentially explosive atmospheres.

## 2.2 General Safety Instructions



**WARNING:**

Only devices in compliance with SELV (EN 69050) may be connected to the RS485 and USB interfaces.



**WARNING:**

Please don't connect PV array positive (+) or negative (-) to ground, it could cause serious damage to the inverter.



**WARNING:**

Electrical installations must be done in accordance with the local and national electrical safety standards.



**WARNING:**

Do not touch any inner live parts until 5 minutes after disconnection from the utility grid and the PV input.



**WARNING:**

To reduce the risk of fire, over-current protective devices (OCPD) are required for circuits connected to the inverter.

The DC OCPD shall be installed per local requirements. All photovoltaic source and output circuit conductors shall have isolators that comply with the NEC Article 690, Part II.



**CAUTION:**

Risk of electric shock, do not remove cover. There is no user serviceable parts inside, refer servicing to qualified and accredited service technicians.



**CAUTION:**

The PV array supplies a DC voltage when they are exposed to sunlight.



**CAUTION:**

The surface temperature of the inverter can reach up to 75°C (167°F). To avoid risk of burns, do not touch the surface of the inverter while it's operating. Inverter must be installed out of the reach of children.



**NOTE:**

PV module used with inverter must have an IEC 61730 Class A rating.



**WARNING:**

Operations below must be accomplished by licensed technician or Solis authorized person.



**WARNING:**

Operator must put on the technicians' gloves during the whole process in case of any electrical hazards.



**WARNING:**

AC BACKUP Port of S6 Series is not allowed to connect to the grid.



**WARNING:**

Please refer to the specification of the battery before configuration.

### 2.3 Notice for Use

The inverter has been constructed according to the applicable safety and technical guidelines. Use the inverter in installations that meet the following specifications ONLY:

1. Permanent installation is required.
2. The electrical installation must meet all the applicable regulations and standards.
3. The inverter must be installed according to the instructions stated in this manual.
4. The inverter must be installed according to the correct technical specifications.

### 2.4 Notice for Disposal

This product shall not be disposed of with household waste.

They should be segregated and brought to an appropriate collection point to enable recycling and avoid potential impacts on the environment and human health.

Local rules in waste management shall be respected .









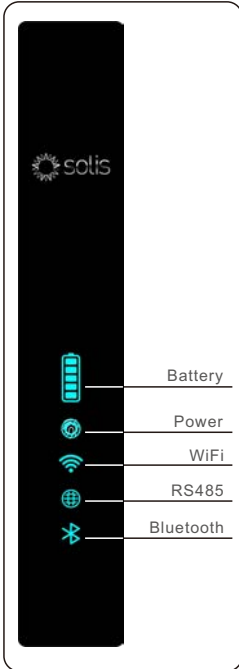

## 3.1 Intelligent LED Indicators

There are five indicators on the The Solis S6 Series Inverter (Battery, Power, WiFi, Ethernet and Bluetooth) which indicate the working status of the inverter.

The Bluetooth antenna or WiFi datalogger shall be installed at the Antenna/COM port of the hybrid inverter before local debugging.



Light	Status	Description
 Battery	Blue flashing every 3s	Battery discharging.
	Blue flashing every 1.5s	Battery charging.
	Blue solid ON	Idle.
	OFF	No battery or not working.
 Power	Blue solid ON	Normally operating.
	Yellow solid ON	Warning.
	RedSolid ON or flashing every 3s	Alarm.
	OFF	No battery or not working.
 WiFi	Blue solid ON	COM port is being used.
	OFF	COM port is not used.
 RS485	Blue solid ON	RS485 port is being used.
	OFF	RS485 port is not used.
 Bluetooth	Blue solid ON	Bluetooth port is being used.
	OFF	Bluetooth port is not used.

### Turning On the LED Indicator Lights

After a few minutes, the LED indicator lights will turn off to save power. To turn the lights back on, short-press the inverter LED light.



### Alarm State

When the inverter has an alarm, the inverter LED light turns red and starts flashing. It is recommended to connect to the inverter with the Bluetooth tool. Then you can determine what the alarm code is.



### NOTE:

Battery/WiFi/Ethernet/Bluetooth indicators will automatically turn off after 1 minute. The Power indicator will remain on with lower brightness. Short press the Power indicator will wake up all indicators.

## 3.2 System Description

### 3.2.1 Single system

The single system consists of PV module, battery, hybrid inverter, CT or smart meter. The PV Module converts solar energy into electric energy, which is then converted by the inverter to charge the battery or power loads or feed into the grid.

User can connect heat pump, existing PV plant, generator and ATS according to the actual scenario.

The system has four working modes: self-use mode, feed in priority mode, off-grid mode and peak-shaving mode. (For settings ,see 5.5 work modes and settings)

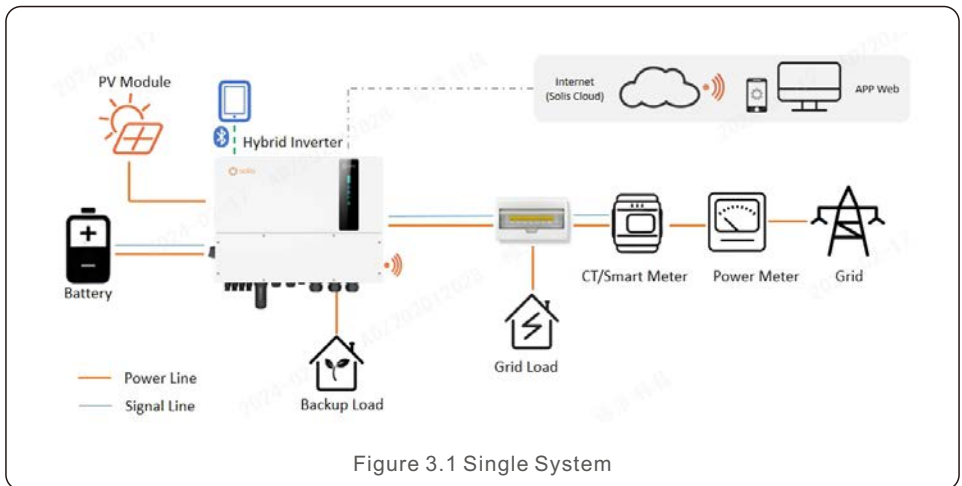

Figure 3.1 Single System



**NOTE:**

- If the CTs are connected, the Smart meter is not essential.
- you can choose CT scheme or Meter scheme deliver with inverter.
- In the event of a power outage on the grid, the system will seamlessly transition into off-grid mode, providing power exclusively to essential backup loads.
- When the grid recovers, the system switches back to the on-grid operation.
- Supports heat pump start-stop and power control, only when it has a SG Ready label.

## 3.2.2 Parallel System

User can add inverters and batteries to increase capacity. The system supports up to 6 inverters in parallel. Each battery connects to the inverter with an independent CAN line and is managed by the inverter connected to it.

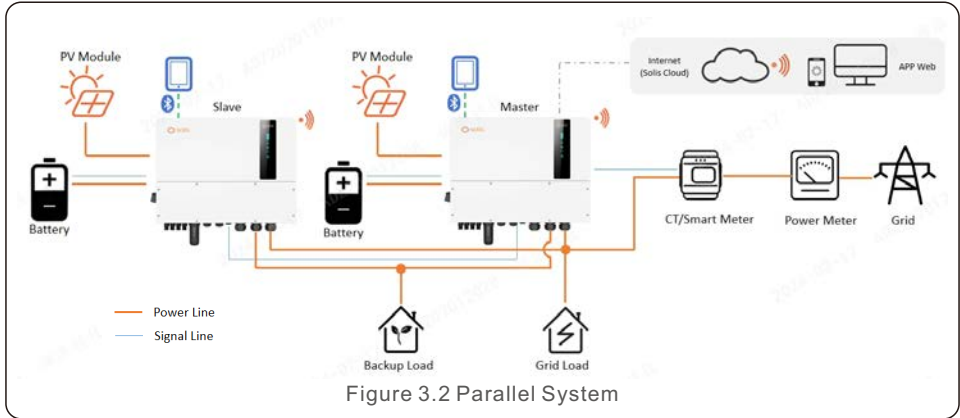

**NOTE:**

- CTs or Smart meter, Control signal of Heat Pump, Control signal of Generator or ATS should be connected to the master inverter.
- CTs delivered with the device can only support a system of up to 60 KW. If a higher power parallel system is required, you need to purchase additional Cts.
- Parallel connection of different models is not supported. (For example 12K and 15K can't be connected in parallel)
- Parallel connection of battery input port is not supported.
- The AC backup port can be connected in parallel, and the single-phase output power is 1/2 of the total rated power.
- The length and specification of the cable connecting the backup load to each inverter needs to be the same to ensure that the current is evenly distributed and prevents one of the inverters from being damaged by excessive current.
- In parallel-system scenarios, it is advisable to ensure uniform specifications and capacities for batteries on both the master and slave inverters. In cases where there is a disparity, it is recommended to connect the battery with a larger capacity to the master inverter. Connecting a higher-capacity battery to a slave inverter may result in incomplete discharge during high-load scenarios.



**NOTE:**

Single inverter noise is less than 65 dB (A), When using multiple inverters to combine, pay attention to noise protection.

Scenarios	12K	15K	20K	8K-LV	10K-LV	12K-LV	Backup single-phase output power (For example 12K)	Recommended Battery Capacity (For example, 12K&Backup 2h)
	AC capacity							
1 single	12K	15K	20K	8K	10K	12K	6K	24KWh
2 in parallel	24K	30K	40K	16K	20K	24K	12K	24KWh*2
3 in parallel	36K	45K	60K	24K	30K	36K	18K	24KWh*3
4 in parallel	48K	60K	80K	32K	40K	48K	24K	24KWh*4
5 in parallel	60K	75K	100K	40K	50K	60K	30K	24KWh*5
6 in parallel	72K	90K	120K	48K	60K	72K	36K	24KWh*6

For parallel system settings ,see 5.9 parallel settings .

For the details of electrical connections ,see 4 Installtion .

### 3.2.3 System with generator

The access of Diesel Generator is in the off-grid scenario.

The system stores PV energy in batteries during daytime, provided that there is energy surplus and supplies power to loads when the PV energy is insufficient or there is no PV energy at night.

When the battery power drops to a certain value, and a power outage occurs in the grid, the system will start the generator to power the load and charge the battery.

Generator's work logic is as follows:

**(i)**when the grid is not available and the battery is discharged to GEN\_Start\_SOC, the generator starts to power the load and charges the battery to GEN\_Exit\_SOC, then the generator stops.

**(ii)**If the load power > the generator rated power in (i), the battery will be discharged to power the load until Overdischarge\_SOC, then generator may shutdown due to overload and the load will be powered off.

**(iii)**If the generator fail to start in (i), the battery will be discharge to Overdischarge\_SOC, then the load power off.

**(iv)**If the system goes into the end of (iii), the battery will not discharge before it is charged to Overdischarge\_SOC+ Overdischarge\_Hysteresis\_SOC (set by user).

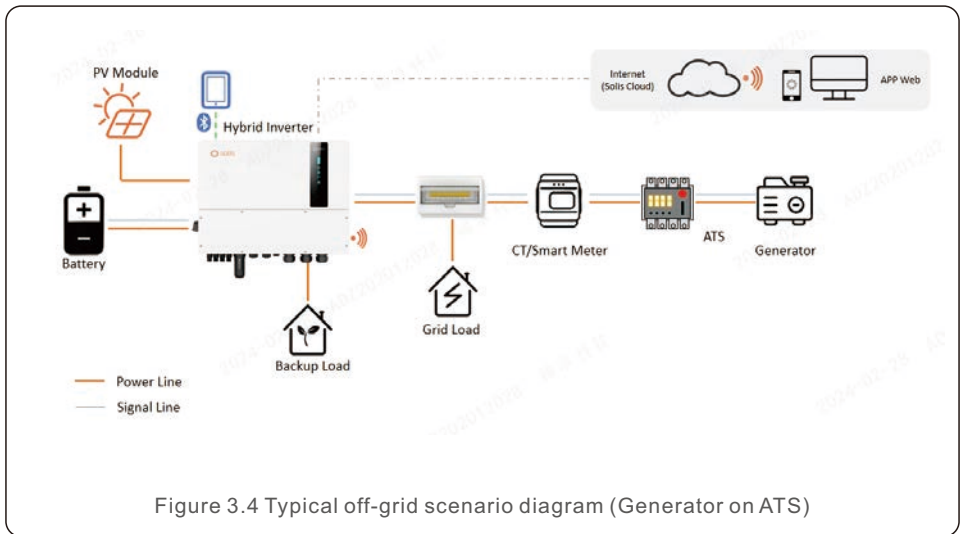
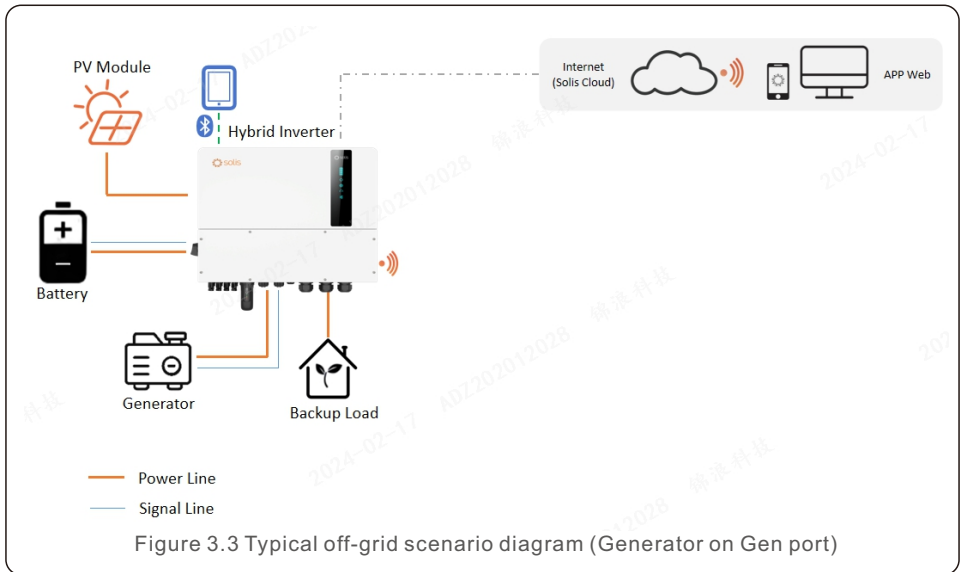

**CAUTION:** When the generator is connected, it is essential to correctly select the generator position on the APP, otherwise it may cause system failure or damage to the generator.



**NOTE:**

- In single system, a diesel generator can be connected via both AC-Gen port and ATS. If via AC-Gen port, it will only supply power to the backup load ; if it is necessary to supply power to the grid side, it is recommended that the generator be connected through ATS.
- In parallel-system scenarios, connecting a diesel generator via ATS is recommended.
- When the system is connected to the generator, it cannot be connected to a grid-tied inverter, because of a risk of damaging the generator.
- Whether CT or smart meter is required depends on the access position of the generator.
- If the generator is connected through an ATS on the grid side(Figure 3.4), then CT or smart meter is required.

### 3.2.4 System with grid-tied inverter

Generally, the access of grid-tied inverter is for the retrofit of a existing PV plant. The S6 hybrid inverter support access of both Solis grid-tied inverter and third-party grid-tied inverter.

#### 3.2.4.1 Access of third-party grid-tied inverter

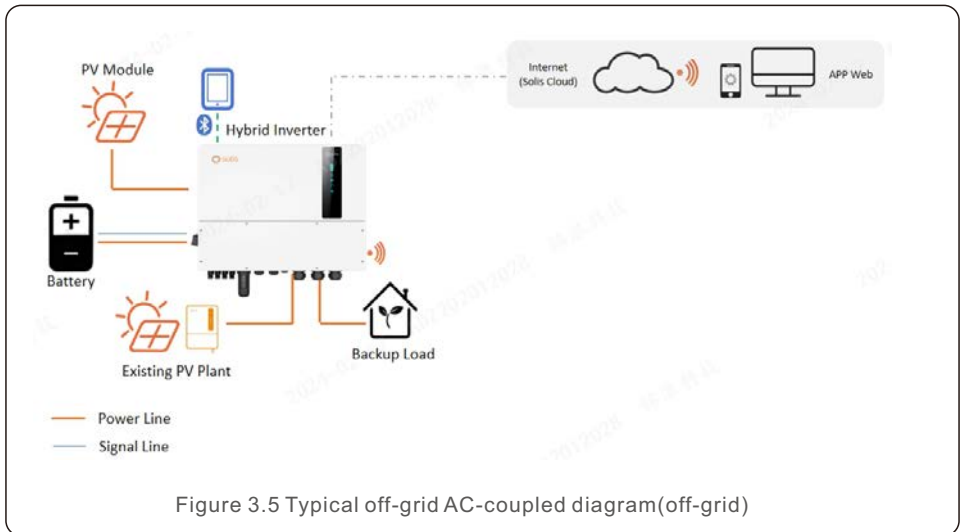
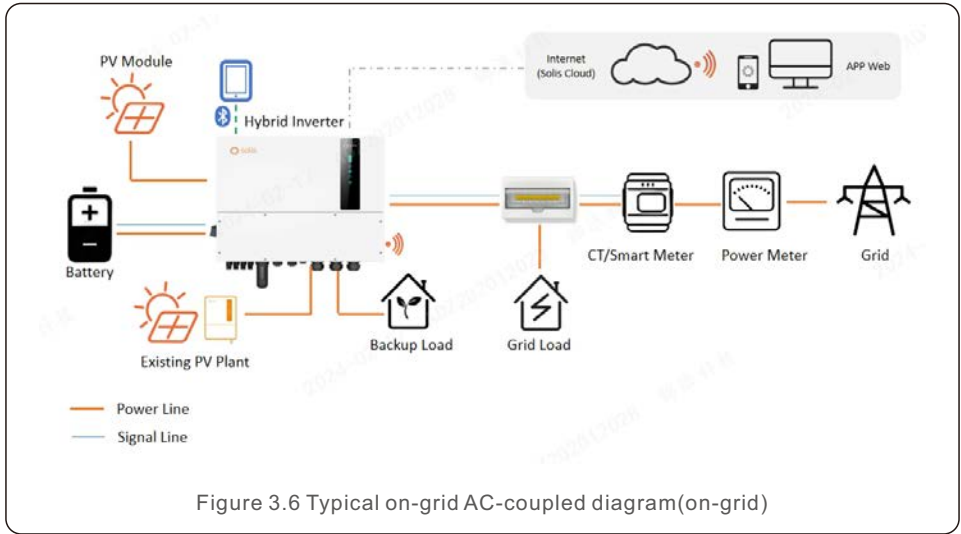
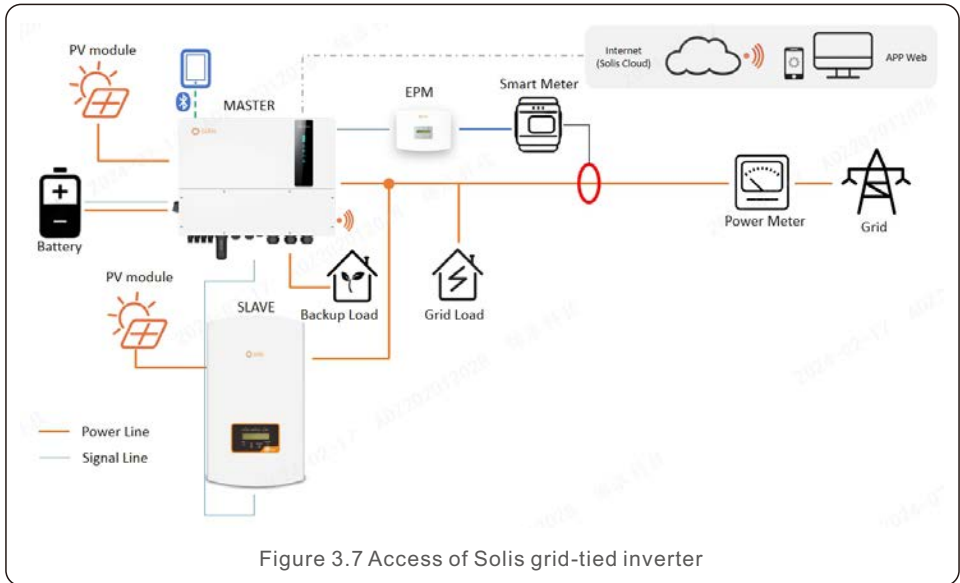

Figure 3.5 Typical off-grid AC-coupled diagram(off-grid)



- Third-party grid-tied inverter can be connected via AC-Gen port and AC-Backup port.
- With third-party grid-tied inverter connected to the system, it is recommended that:  
Grid-tied inverter power < rated AC power of S6 inverter.
- In on-grid scenario, when the third-party grid-tied inverter is connected, the system cannot control the output power of the third-party grid-tied inverter, so Feed-in limitation cannot be realized.
- In off-grid scenario, the third-party grid-tied inverter must be configured with the correct grid code and equipped with over-frequency load shedding and under-frequency load rising functionalities. These features allow the system to dynamically adjust the frequency, effectively controlling the output power of the grid-tied inverter.

## 3.2.4.2 Access of Solis grid-tied inverter



**NOTE:**

A Solis grid-tied inverter can be connected with the hybrid inverter in parallel. In order to realize feed-in limitation, it is necessary to add EPM or S3-Logger devices.



## 4.1 Select a Location for the Inverter

To select a location for the inverter, the following criteria should be considered:

- Exposure to direct sunlight may cause output power derating. It is recommended to avoid installing the inverter in direct sunlight.
- It is recommended that the inverter is installed in a cooler ambient which doesn't exceed 104°F/40°C.
- To select a location for the battery, please follow the battery manual specifications.

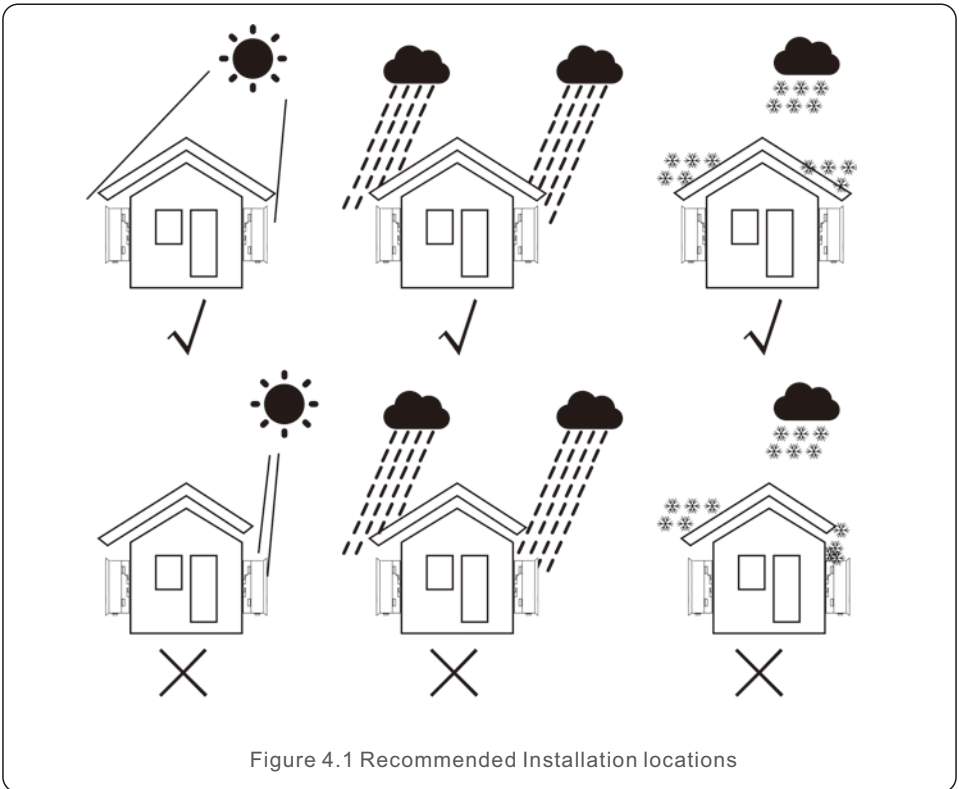

Figure 4.1 Recommended Installation locations



**WARNING: Risk of fire**

Despite careful construction, electrical devices can cause fires.

- Do not install the inverter in areas containing highly flammable materials or gases.
- Do not install the inverter in potentially explosive atmospheres.
- The mounting structure where the inverter is installed must be fireproof.

- Install on a wall or strong structure capable of bearing the weight of the machine (33.4kg).
- Install vertically with a maximum incline of +/- 5 degrees, exceeding this may cause output power derating.
- To avoid overheating, always make sure the flow of air around the inverter is not blocked. A minimum clearance of 500mm should be kept between inverters or objects and 1000mm clearance between the bottom of the machine and the ground.

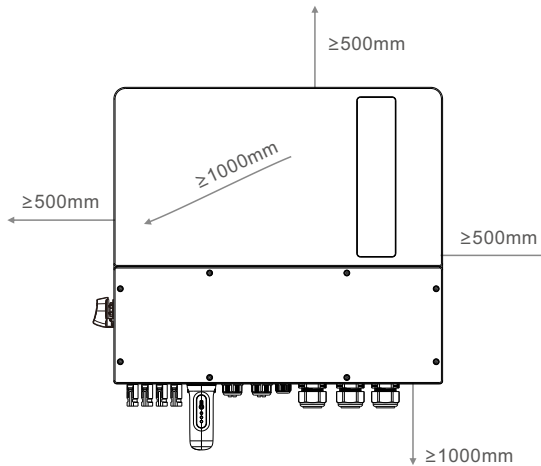

Figure 4.2 Inverter Mounting clearance

- Adequate ventilation must be provided.



**NOTE:**

Nothing should be stored on or placed against the inverter.



**NOTE**

If the inverter is installed in areas with high wind and sand, it is recommended to install a windproof and sand barrier above the inverter.

## 4.2 Mounting the Inverter

Dimensions of mounting bracket:

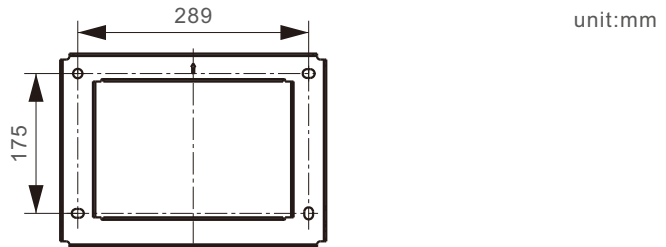

Figure 4.3 Inverter wall mounting

Once a suitable location has been found according to Section 4.1 and using Figure 4.3 as a guide, firmly attach the wall bracket to the wall.

The inverter shall be mounted vertically.

The steps to mount the inverter are listed below:

1. Select the mounting height of the bracket and mark the mounting holes.  
For brick walls, the position of the holes should be suitable for the expansion bolts.
2. Lift up the inverter (be careful to avoid body strain), and align the back bracket on the inverter with the convex section of the mounting bracket. Hang the inverter on the mounting bracket and make sure the inverter is secure (see Figure 4.4)

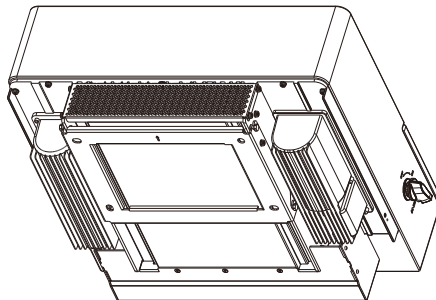

Figure 4.4 Wall Mount Bracket



**WARNING:**

The inverter must be mounted vertically.

## 4.3 PE Cable Installation

An external ground connection is provided at the right side of inverter.

Prepare OT terminals: M4. Use proper tooling to crimp the lug to the terminal.

Connect the OT terminal with ground cable to the both sides of inveter. The torque is 2N.m.

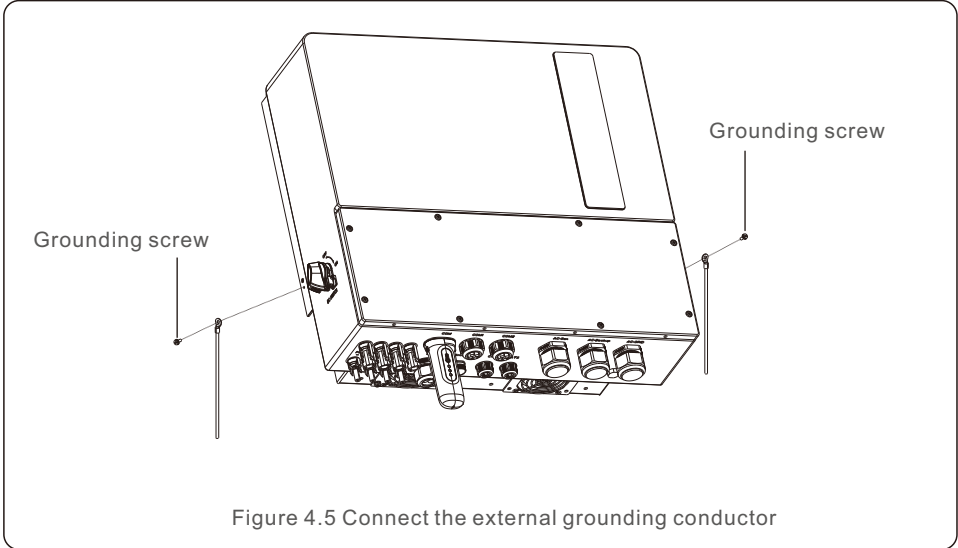

Figure 4.5 Connect the external grounding conductor

## 4.4 PV Input Cable Installation



Before connecting inverter, please make sure the PV array open circuit voltage is within the limit of the inverter.



Before connection, please make sure the polarity of the output voltage of PV array matches the "DC+" and "DC-" symbols.



Please use approved DC cable for PV system.

1. Select a suitable DC cable and strip the wires out by  $7\pm 0.5\text{mm}$ . Please refer to the table below for specific specifications.

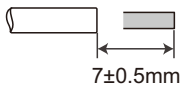

Cable type	Cross section (mm <sup>2</sup> )	
	Range	Recommended value
Industry generic PV cable	4.0~6.0 (10~8AWG)	4.0 (10AWG)

Figure 4.6

2. Take the DC terminal out of the accessory bag, turn the screw cap to disassemble it, and take out the waterproof rubber ring.

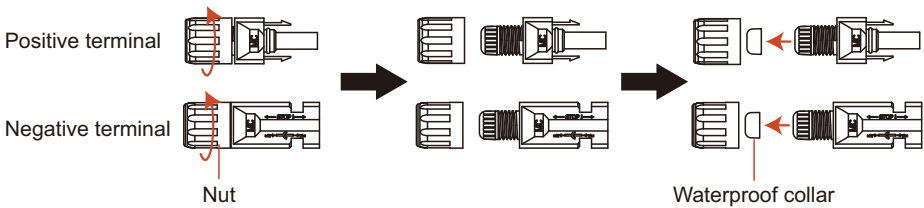
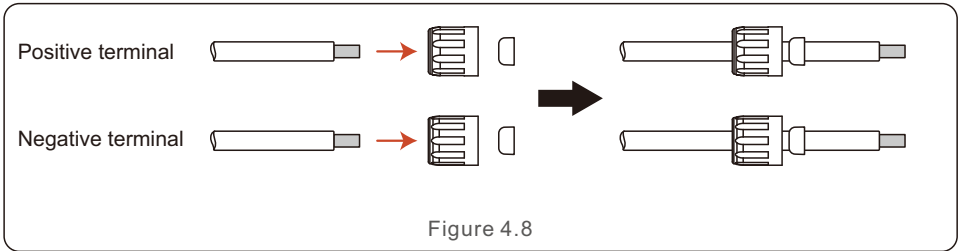
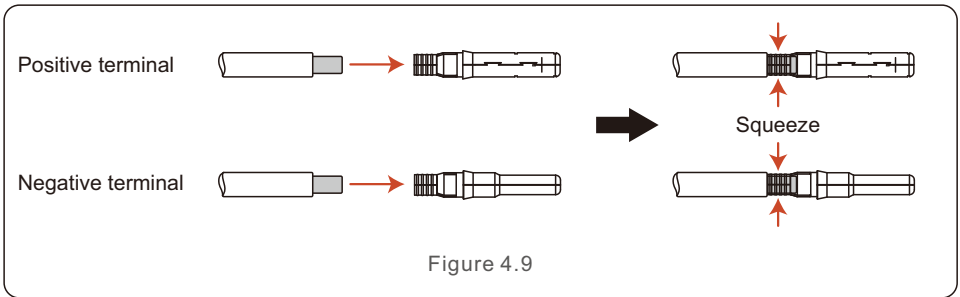

Figure 4.7

3. Pass the stripped DC cable through the nut and waterproof rubber ring.



4. Connect the wire part of the DC cable to the metal DC terminal and crimp it with the MC4 crimping tool.



5. Insert the crimped DC cable into the DC terminal firmly, then insert the waterproof rubber ring into the DC terminal and tighten the nut.

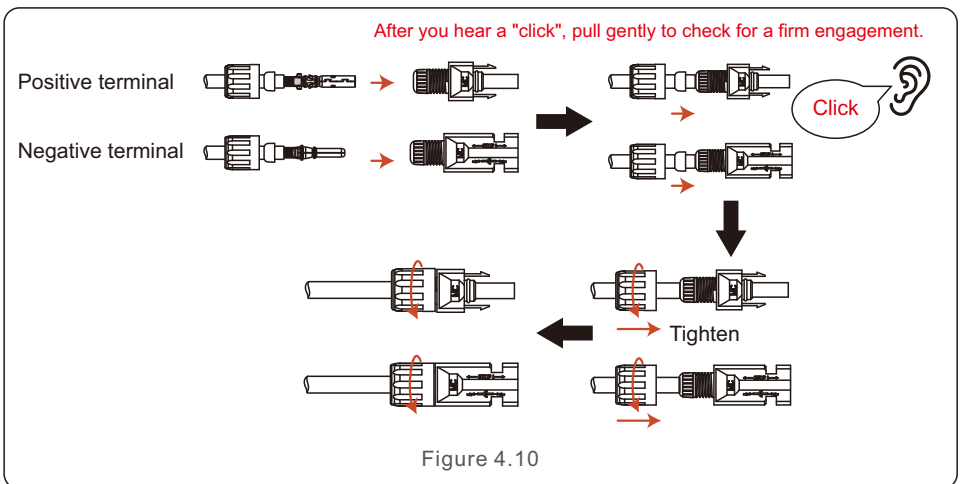

6. Measure PV voltage of DC input with multimeter, verify DC input cable polarity.

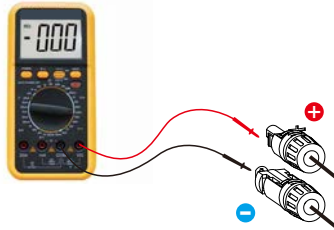

Figure 4.11

7. Connect the wired DC terminal to the inverter as shown in the Figure 4.12, and a slight "click" is heard to prove the connection is correct.

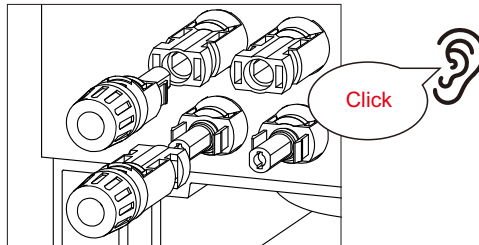

Figure 4.12



**CAUTION:**

If DC inputs are accidentally reversely connected or inverter is faulty or not working properly, it is NOT allowed to turn off the DC switch. Otherwise it may cause DC arc and damage the inverter or even lead to a fire disaster. The correct actions are:

\*Use a clip-on ammeter to measure the DC string current.

\*If it is above 0.5A, please wait for the solar irradiance to get reduced until the current decreases to below 0.5A.

\*Only after the current is below 0.5A, you are allowed to turn off the DC switches and disconnect the PV strings.

\* In order to completely eliminate the possibility of failure, please disconnect the PV strings after turning off the DC switch to avoid secondary failures due to continuous PV energy on the next day.

**Please note that any damages due to wrong operations are not covered in the device warranty.**

## 4.5 Battery Cable Installation



**DANGER:**

Before installing the battery cables, be sure that the battery is turned off. Use a multimeter to verify that the battery voltage is 0Vdc before proceeding. Consult the battery product manual for instructions on how to turn it off.

1. The battery (+) and (-) cables shall only be connected to the inverter BAT terminals.
2. Run the cables into the wire box. Strip 13mm off the ends of each cable.
3. Crimp the R-type connectors onto the cables. Do not over crimp the connectors.
4. Remove the terminal bolts and then insert them through the connector holes.
5. Put each bolt back into the proper place, be sure to not reverse the polarity.
6. Tighten the bolts with a torque wrench screwdriver following the torque specs.
7. Battery Breaker recommended size: two-pole, 63A, leakage current protector recommended Type C,  $I_{cc} \geq 20KA$ ,  $I_{cp}$ ,  $m \geq 350A$  fault current interrupting capacity at 800V/pole.

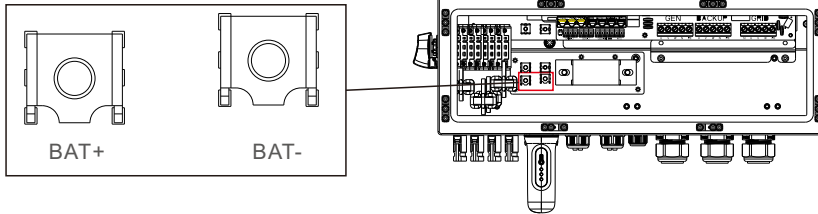

OT Terminal: R60-8, Recommended cable diameter: 8AWG(8.37mm<sup>2</sup>)

Figure 4.13 Battery cable connection



**NOTE:**

The battery fuse in the inverter wire box is replaceable. The replacement can only be done by a technician authorized by Solis. Fuse specification: 1000V/100A. The Max.temperature for connecting battery terminals is 105°C.



**NOTE:**

Before connecting the battery, please carefully read the product manual of the battery and perform the installation exactly as the battery manufacturer specifies in the manual.



## 4.6 AC Wiring



**DANGER:**

Before installing the AC cables, be sure that the OCPDs (breakers) are turned off.

Use a multimeter to verify that the AC voltages are 0Vac before proceeding.

There are three sets of AC output terminals and the installation steps for both are the same.

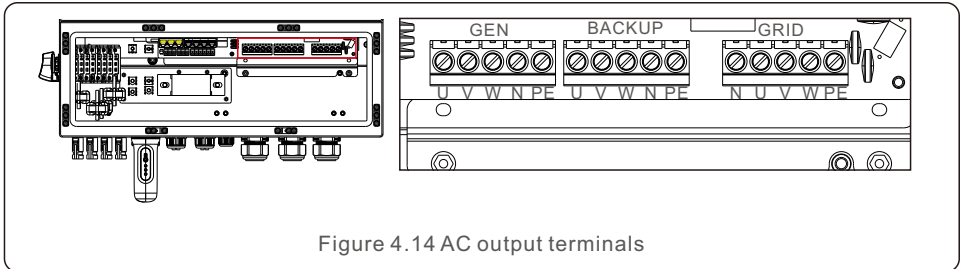

Figure 4.14 AC output terminals

Model	AC Grid	AC Backup/AC Gen	PE
Terminal	C10-12	C6-12	/
Torque	4-5N.m	4-5N.m	4-5N.m
Recommend cross section	8-6AWG (6mm <sup>2</sup> ~10mm <sup>2</sup> )	10-6AWG (4mm <sup>2</sup> ~10mm <sup>2</sup> )	6AWG

1. Bring the AC cables for the backup loads panel (backup) and the main service panel (grid) into the inverter wire box. The backup loads panel should not be electrically connected to the main service panel.
2. Strip 13mm from the ends of each cable. Crimp the R-type connectors onto the ends.
3. Remove the terminal bolts, insert them into the connectors, then use a torque wrench to tighten the bolts down.
4. Please refer to the terminal labels to connect the AC wires to the correct terminals.
5. The grid inrush current is 8.5A and the duration is less than 5ms.
6. AC Breaker recommended size: four-pole, 63A, leakage current protector recommended Type C, Icc≥20KA, Icp, mr≥350A fault current interrupting capacity at 230V/pole.
7. Cable Gland are recommended torque for installation is 4-5Nm. In order to ensure waterproof effect, the operator regularly checks whether the installation is tight.



**NOTE:**

The Max.temperature for connecting AC terminals is 105°C.

## 4.7 CT Connection



**CAUTION:**

Make sure the AC cable is totally isolated from AC power before connecting the smart meter or CT.

The CT provided in the product box is compulsory for hybrid system installation. It can be used to detect the grid current direction and provide the system operating condition to hybrid inverter.

CT Model: 120A/40mA\_0.5%, ESCT-TA16 120A/40mA

CT Cable: Size – 2.3mm<sup>2</sup>, Length - 1m

Please install the CT on the phase lines at the system grid connection point and the arrow on the CT needs to point to the grid direction.

Lead the CT wires through the CT port at the bottom of the inverter and connect the CT wires to the 6 pin communication terminal block.

CT Wire	6 PIN Communication Terminal Block
White	Pin 1 (From Left to Right)
Black	Pin 2 (From Left to Right)

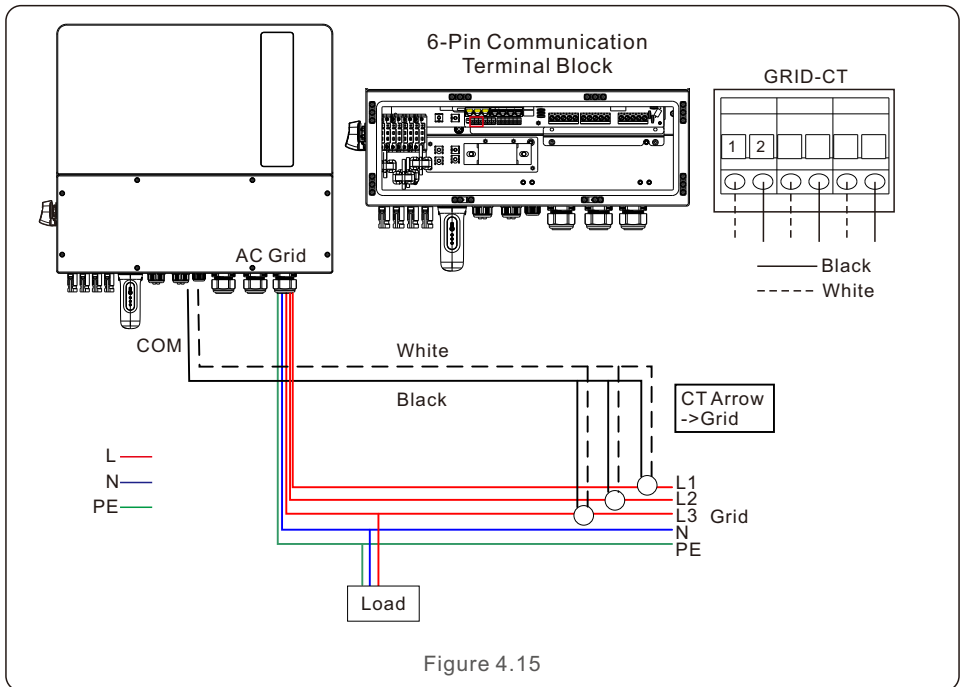
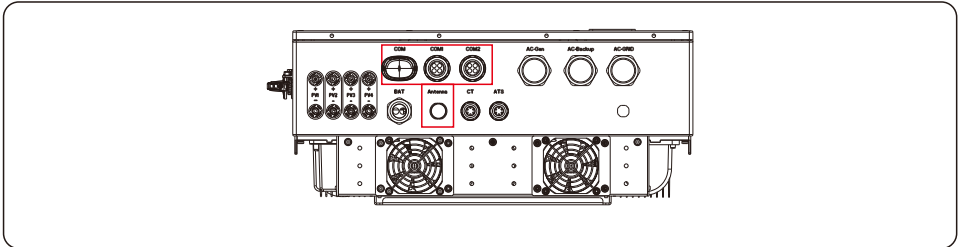

Figure 4.15

## 4.8 Inverter Communication

### 4.8.1 Communication Ports



Port	Port Type	Description
COM	USB	Used for Solis data logger connection
ANTENNA	Antenna	Used for antenna connection for built in Bluetooth signal
COM1	4 hole watertight cable gland	Used for RJ45 connection inside wiring box
COM2	4 hole watertight cable gland	Used for RJ45 connection inside wiring box

Wiring steps for COM1-COM2:

- Step 1. Loose the cable gland and remove the watertight caps inside the cable gland based on the number of the cables and keep the unused holes with watertight cap.
- Step 2. Lead the cable into the holes in the cable gland.  
(COM1-COM2 Hole Diameter: 6mm)
- Step 3. Connect the cable to the corresponding terminals inside the wiring box.
- Step 4. Reassemble the cable gland and ensure there is no bending or stretching of the cables inside the wiring box.



**NOTE:**

The 4-hole fastening rings inside the cable gland for COM1 and COM2 are with openings on the side.

Please separate the gap with hand and squeeze the cables into the holes from the side openings.

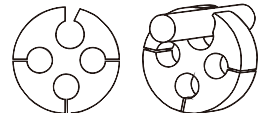

## 4.8.2 Communication Terminals

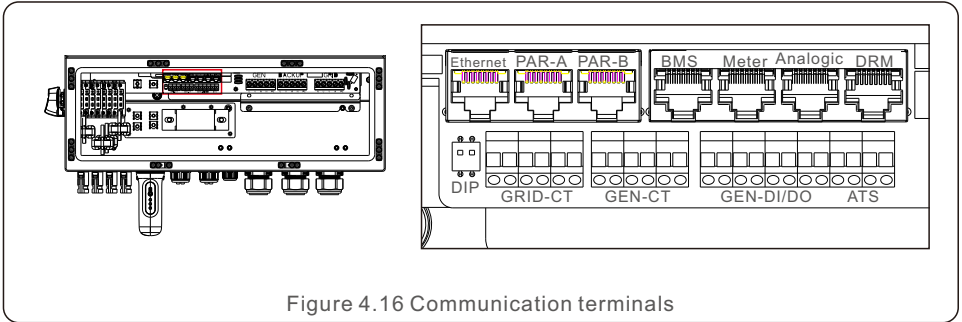

Figure 4.16 Communication terminals

Terminal	Type	Description
Ethernet	RJ45	Used for Ethernet communication.
PAR-A	RJ45	(Optional) Parallel operation communication port.
PAR-B	RJ45	(Optional) Parallel operation communication port.
BMS	RJ45	Used for CAN communication between inverter and Lithium battery BMS.
Meter	RJ45	(Optional)Used for RS485 communication between inverter and the smart meter.
Analogic	RJ45	Used for output analogic signal.
DRM	RJ45	(Optional) To realize demand response or logic interface function, this function may be required in UK and Australia.
DIP Switch (2-1)	-	When a single inverter is running, DIP switch 1 and 2 shall be both at the bottom position. When multiple inverters are paralleled, DIP switch: Option 1: Both the first and last inverter (INV1 & INV3) have 1 of the DIP switch enabled (Either Pin1 or Pin2). Option 2: One of the first and the last inverter (INV1 or INV3) has 2 DIP switches enabled (Both Pin1 & Pin2)

## 4.8.3 BMS terminal connection

### 4.8.3.1 With lithium battery

CAN communication is supported between inverter and compatible battery models. Please lead the CAN cable through the COM1 or COM2 port of the inverter and connect to the BMS terminal with RJ45 connector.

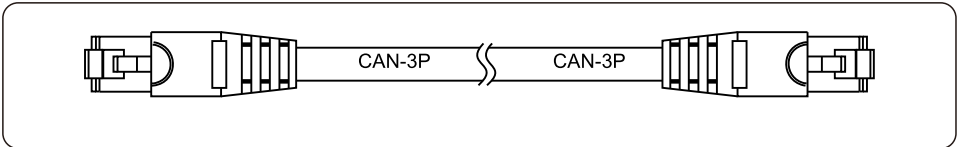

#### NOTE:

Before connecting CAN cable with the battery, please check whether the communication pin sequence of the inverter and the battery match; If it does not match, you need to cut off the RJ45 connector at one end of the CAN cable and adjust the pin sequence according to the pin definitions of both inverter and battery.

Pin definition of the inverter BMS port is following EIA/TIA 568B.

CAN-H on Pin 4: blue

CAN-L on Pin 5: blue/white

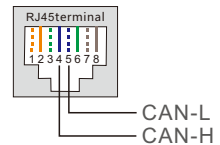

## 4.8.5 DRM port connection (Optional)

### 4.8.5.1 For remote shutdown function

Solis inverters support remote shutdown function to remotely control the inverter to power on and off through logic signals.

The DRM port is provided with an RJ45 terminal and its Pin5 and Pin6 can be used for remote shutdown function.

Signal	Function
Short Pin5 and Pin6	Inverter generates
Open Pin5 and Pin6	Inverter shutdown in 5s

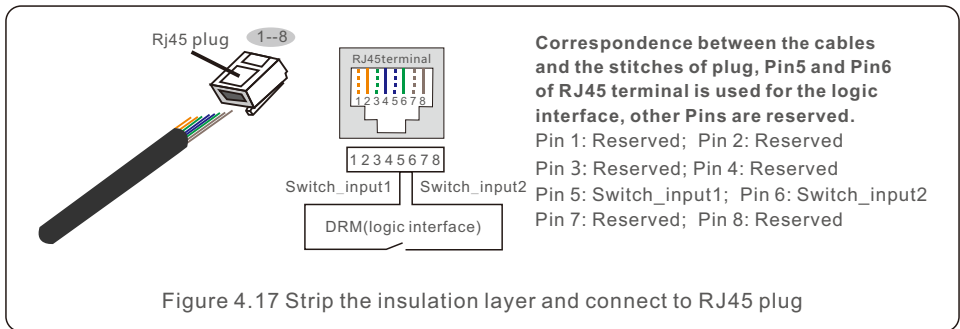

### 4.8.5.2 For DRED Control Function (For AU and NZ Only)

DRED means demand response enable device. The AS/NZS 4777.2:2020 required inverter need to support demand response mode(DRM).

This function is for inverter that comply with AS/NZS 4777.2:2020 standard.

A RJ45 terminal is used for DRM connection.

Pin	Assignment for inverters capable of both charging and discharging	Pin	Assignment for inverters capable of both charging and discharging
1	DRM 1/5	5	RefGen
2	DRM 2/6	6	Com/DRM0
3	DRM 3/7	7	V+
4	DRM 4/8	8	V-



**NOTE:**

Solis hybrid inverter is designed to provide 12V power for DRED.

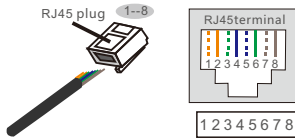

**Correspondence between the cables and the stitches of plug**  
 Pin 1: white and orange; Pin 2: orange  
 Pin 3: white and green; Pin 4: blue  
 Pin 5: white and blue; Pin 6: green  
 Pin 7: white and brown; Pin 8: brown

Figure 4.18 Strip the insulation layer and connect to RJ45 plug

### 4.8.6 RS485 Port connection (Optional)

If a 3rd party external device or controller needs to communicate with the inverter, the RS485 port can be used. Modbus RTU protocol is supported by Solis inverters.

To acquire latest protocol document, please contact Solis local service team or Solis sales.



**NOTE:**  
 Pin definition of the RS485 Port is following EIA/TIA 568B.  
 RS485A on Pin 5: blue/white  
 RS485B on Pin 4: blue

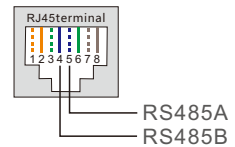

### 4.8.7 Parallel Inverter Connection (Optional)

Up to 6 units of the inverter can be connected in parallel.

Please connect the paralleled inverters by using P-A and P-B terminals.

Standard CAT5 with shielding layers internet cable can be used.

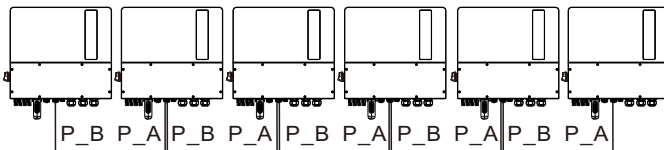

Figure 4.19 Parallel Terminal Connection



**NOTE:**  
 Please upgrade the latest software version before you want use the inverter in parallel mode.

## 4.8.8 12-pin Communication Terminal Block

Terminal Block Connection Steps:

Step 1. Lead the wires through the hole in COM1 or COM2 port (Hole Diameter: 2 mm)

Step 2. Strip the wires for 9mm length

Step 3. Use slot type screwdriver to press the block on the top

Step 4. Insert the exposed copper part of the cable into the terminal.

Step 5. Remove the screwdriver and the terminal will clamp down on the exposed copper part.

Step 6. Give the cable a gentle tug to ensure that it is firmly secured.

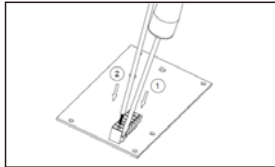

### 4.8.8.1 Heat Pump Control Signal Connection

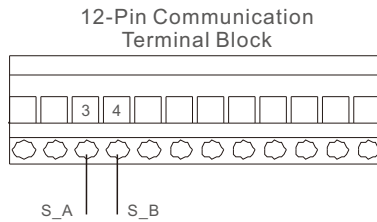

Figure 4.20



### 4.8.8.2 G-V Terminal Connection

The G-V terminal is a voltage-free dry contact signal for connecting with generator's NO relay to start up the generator when necessary.

When generator operation is not needed, Pin3 and Pin4 is in open circuit.

When generator operation is needed, Pin3 and Pin4 is in short circuit.

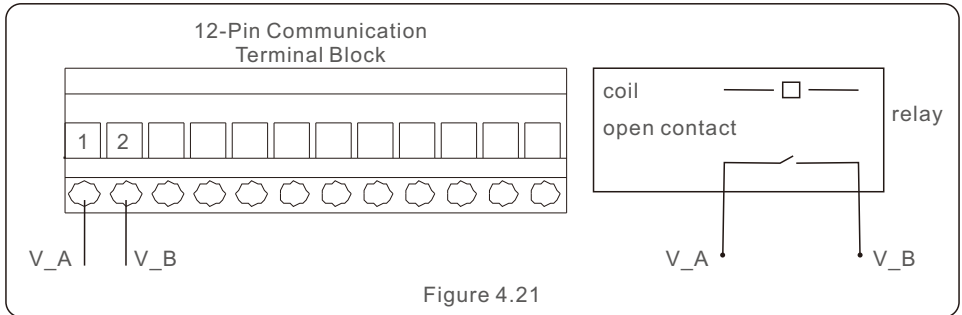

Figure 4.21

### 4.8.8.3 ATS240V Terminal Connection

The ATS240V terminal will output 230V AC voltage when inverter is connected to the grid, when the grid is not available, it will output 0V, then the ATS will transfer to generator.

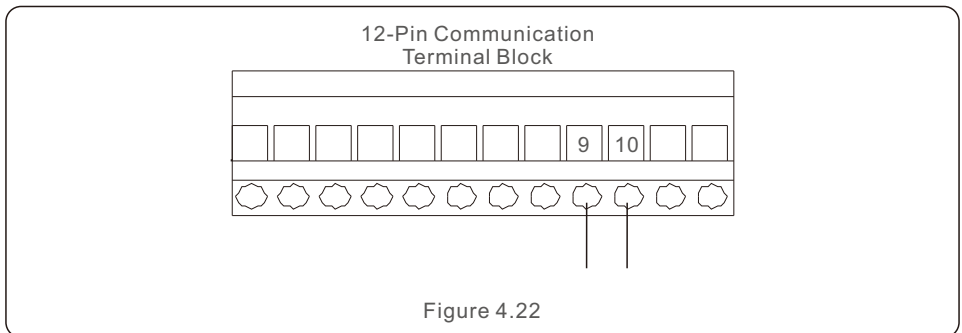

Figure 4.22

## 4.9 Inverter Remote Monitoring Connection

The inverter can be remotely monitored via WiFi, LAN or 4G.

The USB type COM port at the bottom of the inverter can connect to different kinds of Solis dataloggers, enabling remote monitoring through the SolisCloud platform.

To install Solis data loggers, please refer to the corresponding user manuals of Solis data loggers.

The Solis data loggers are optional and can be purchased separately.

Dust cover is provided in the inverter package in case the port is not used.



**WARNING:**

The USB type COM port only supports Solis dataloggers. It is forbidden to be used for other purposes.

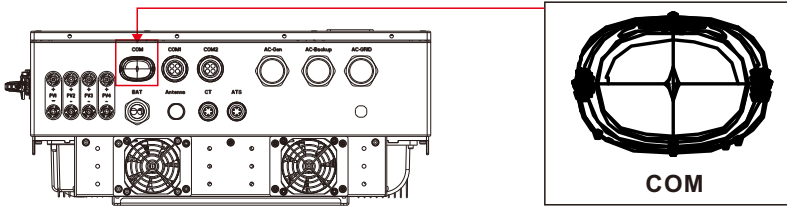

Figure 4.23

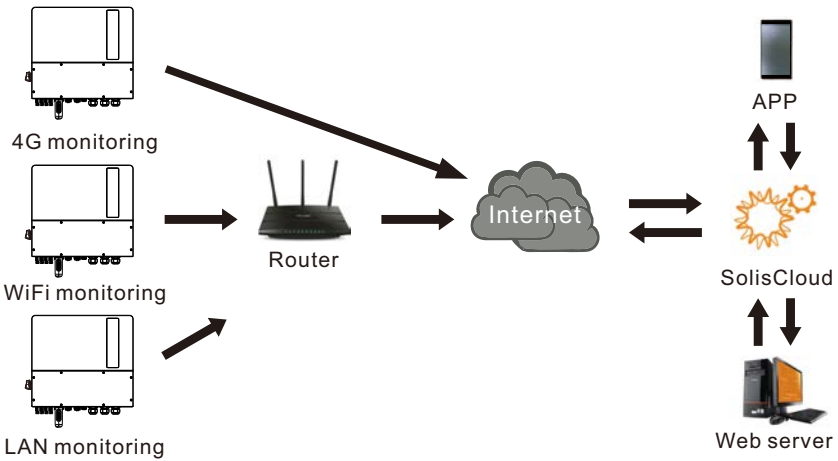

Figure 4.24 Wireless communication function

## 5.1 Preparation of Commissioning

- Ensure that all the devices are accessible for operation, maintenance and service.
- Check and confirm that the inverter is firmly installed.
- Space for ventilation is sufficient for one inverter or multiple inverters.
- Nothing is left on the top of the inverter or battery module.
- Inverter and accessories are correctly connected.
- Cables are routed in safe place or protected against mechanical damage.
- Warning signs and labels are suitably affixed and durable.
- Bluetooth Antenna has been connected to the Antenna port of the inverter.
- An Android or IOS mobile phone with Bluetooth function is available.
- SolisCloud APP is installed on the mobile phone.

There are three ways to download and install the latest APP:

1. You can visit [www.soliscloud.com](http://www.soliscloud.com) to download the latest version APP.
2. You can search “**SolisCloud**” in Google Play or App Store.
3. You can scan this QR code below to download “**SolisCloud**”.



## 5.2 Commissioning Procedure

Step 1: Measure DC voltage of PV strings and battery and ensure the polarity is correct.

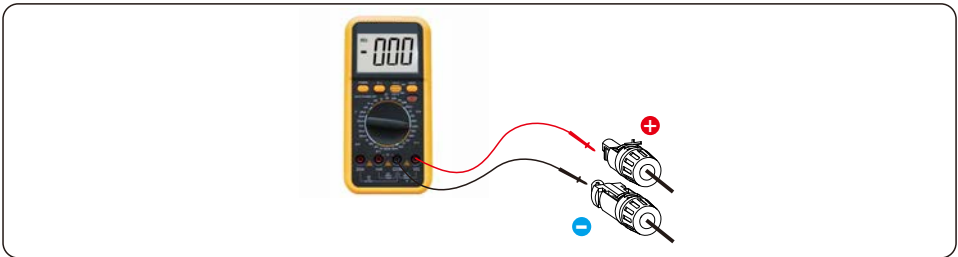

Step 2: Measure AC voltage and frequency and ensure they are within local standard.

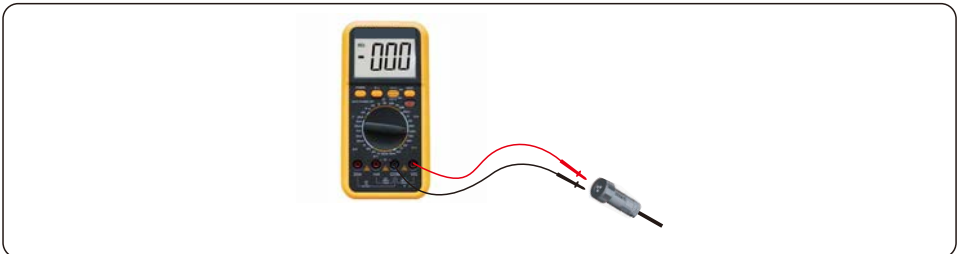

Step 3: Switch on the external AC breaker to power on the inverter control board.  
(Bluetooth signal available)

## 5.3 Quick Settings

### Step 1: **Connect with Bluetooth.**

Turn on Bluetooth switch on your mobile phone and then open the SolisCloud APP. Click "More Tools"->"Local Operation"->"Connect with Bluetooth"

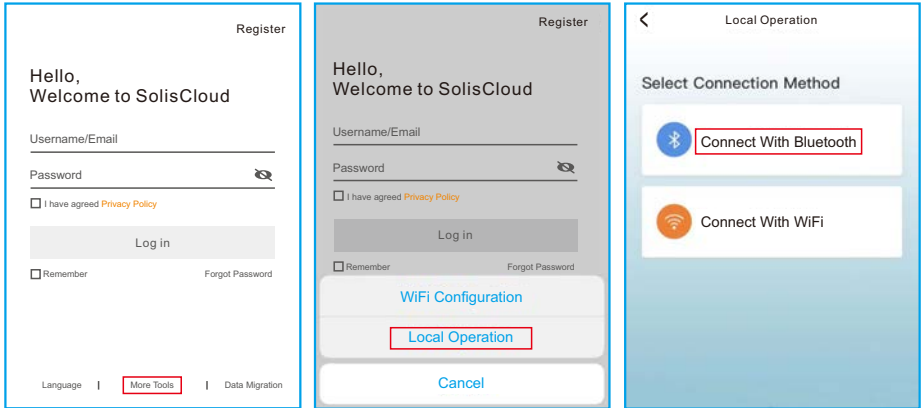

Step 2: Select the Bluetooth signal from the inverter. (Bluetooth Name: Inverter SN)



### Step 3: **Login account.**

If you are the installer, please select the account type as Installer. If you are the plant owner, please select the account type as Owner. Then set your own initial password for control verification. (The first log-in must be finished by an installer in order to do the initial set up)

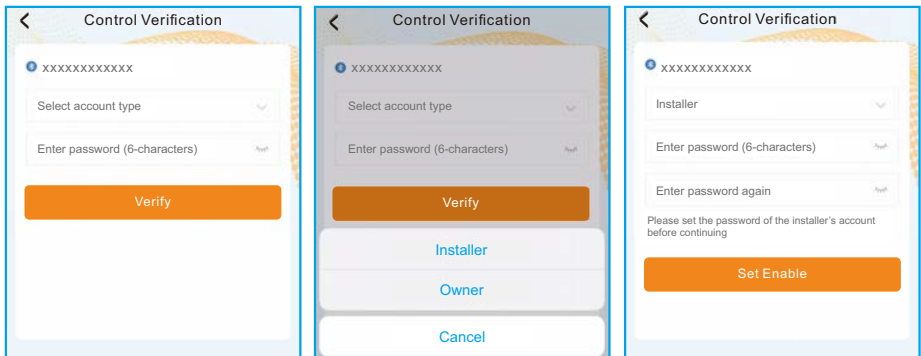

Step 4: After the log in for the first time, initial settings are required.

**Step 4.1: Set the inverter date and time.**

You can set to follow the time on your mobile phone.

**Step 4.2: Set the battery model.**

It must be based on the battery model that is actually connected to the inverter.

If there is no battery connected for the moment, please select “No Battery” to avoid alarms.

The default setting for battery over discharge SOC is 20%, force charge SOC is 10%.

**Step 4.3: Set the meter setting.**

It must be based on the meter type that is actually connected to the inverter.

If there is no meter connected for the moment, please select “No Meter” to avoid alarms.

It is suggested to install the meter at the system grid connection point and select “Meter in Grid”.

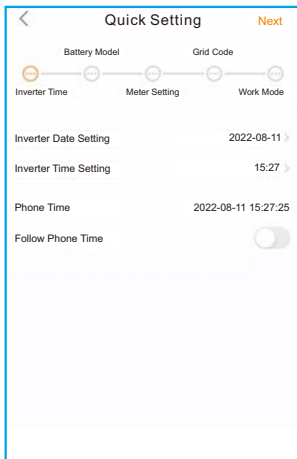

Step 4.1

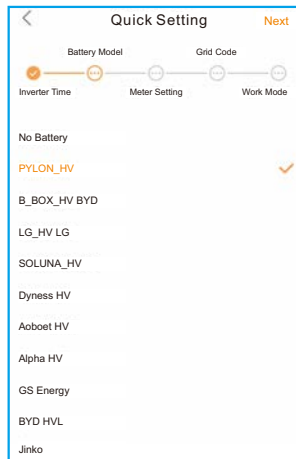

Step 4.2

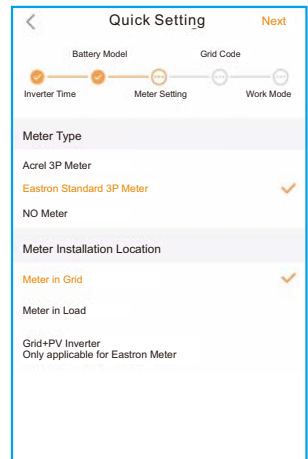

Step 4.3

**Step 4.4: Set the grid code setting.**

Please select the grid code based on the local grid network requirements.

**Step 4.5: Set the work mode setting.**

Recommended setting is Self-Use Mode. This mode will maximize the use of PV power generation for household electricity, or store it in batteries and use it for household electricity. If need manually control the battery charging and discharging with respect to time, please use the Time of Use switch and the following set points. The “Allow Grid Charging” is recommended to be turned on (If turned off, the inverter will not force charge the battery and battery could potentially go to sleep).

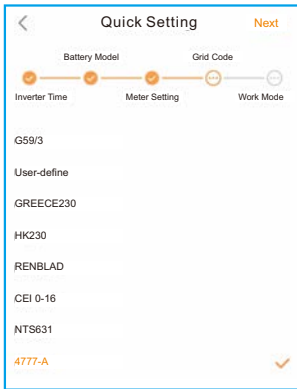

Step 4.4

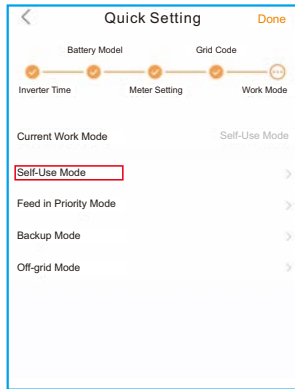

Step 4.5(1)

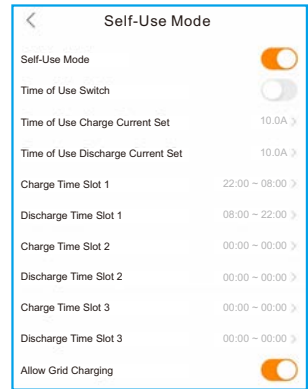

Step 4.5(2)

## Step 5: **Setup complete.**

Now the initial settings on the inverter have been set and you can switch on the inverter's DC switch and switch on battery breaker to start up the system. You can also explore in the APP to check the operating data, alarm message or other advanced settings.

## Step 6: **Change password.**

If the owner forgot the password, please contact the installer. Installer log in and go to "Setting"->"More"->"Change Password" to reset the password for owner's account.

If the installer forgot the password, please contact Solis service team.

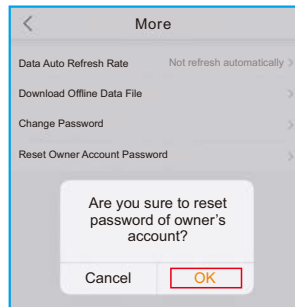
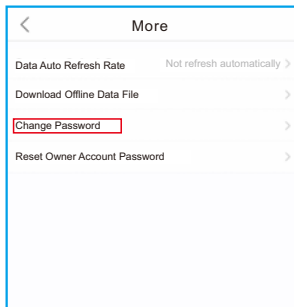

## 5.4 Shutdown procedure

Step 1. Turn off the AC breaker at the grid connection point.

Step 2. Turn off the DC switch of the inverter.

Step 3. Turn off the battery breaker.

Step 4. Wait until the device is powered off, and the system shutdown is complete.

## 5.5 Work Mode and Settings

### 5.5.1 Self-Use mode

Load priority: load>battery>grid

Power supply priority: PV>battery>grid>DG

This mode applies to the area that has low feed-in tariff and high energy price.

The PV power will prioritize supplying energy to the load and charging the battery, with any surplus power being fed into the grid. During periods without PV power at night or when the PV power is insufficient, the battery will discharge to support the load.

- Supports TOU settings in this mode.
- Supports Battery Reserve function in this mode.

### How to set Self-Use mode?

A. Self-Use Mode is activated without any specific times set for the battery to be charged/discharged, and the battery reserve is not switched on.

Note: Solis recommends activating the 'Allow Charging from Grid' option. Once the battery reaches the Forcecharge SOC, it will use the grid to charge the battery, preventing it from being deep discharged.

B. Activating the 'Time of Use Switch' will provide customers with several options to set charging/discharging times and current.

C. Setting the charge or discharge current within the range of 0-50A.

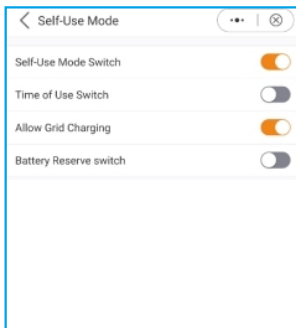

A

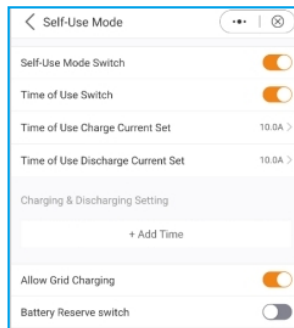

B

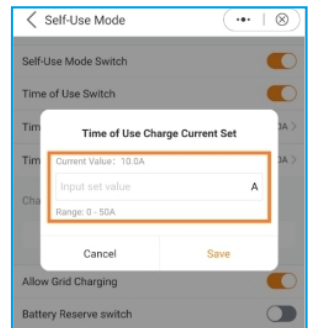

C

D. If you want to set a specific charging or discharging value on your inverter, please first press "Add time" and then choose accordingly – Charging or Discharging Times.

E. In the next step, please choose the actual time range for either Force Charge or Discharge.

F. Once the Charge/Force charge period has been set, you will see the details on the screen.

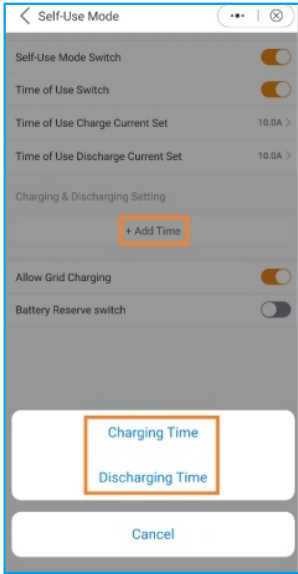

D

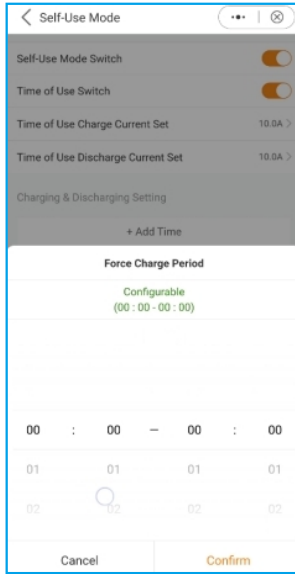

E

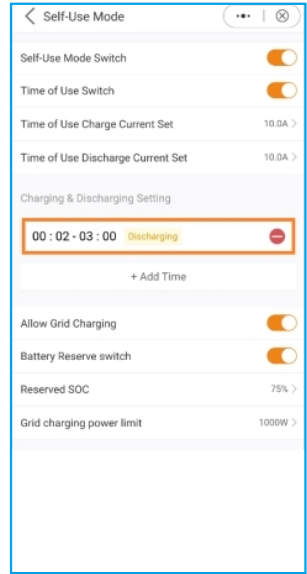

F



G. The Self-Use Mode provides you with the option to set a Battery reserve value.

Please toggle the switch to activate the battery reserve mode.

H. You can set a range between 20% and 100% of the battery SOC. The inverter will strive to maintain the battery at the chosen set level.

I. Finally, you have the option to establish a power limit that can be drawn from the grid side.

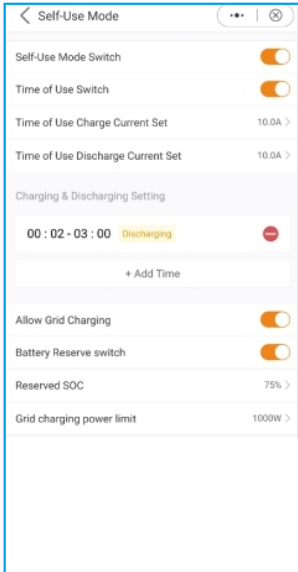

G

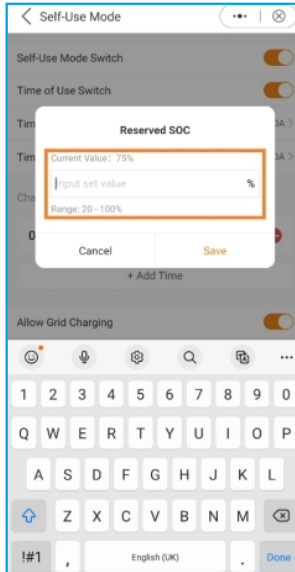

H

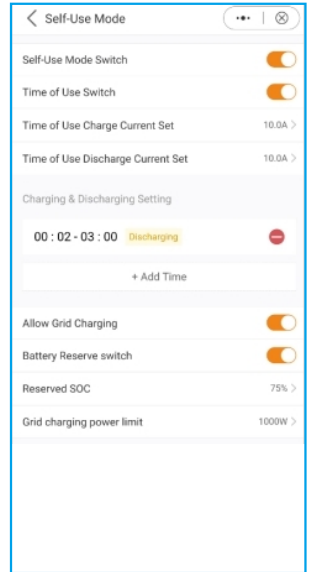

I

## 5.5.2 Feed in Priority Mode

Load priority : load>grid>battery

Power supply priority: PV>battery>grid>DG

This mode applies to the area that has high feed-in tariff and export control.

The PV power will prioritize supplying energy to the load. Then any surplus is directed into the grid.

If there is a feed-in limitation, the excess power will charge the battery.

- Supports TOU setting in this mode.
- Supports Battery Reserve function in this mode.

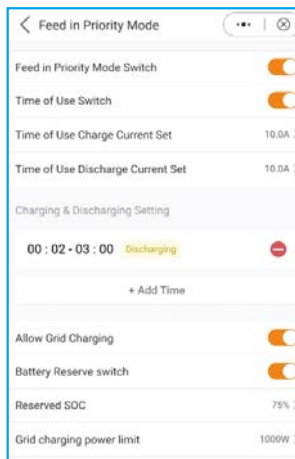

## 5.5.3 Peak-Shaving Mode

Load priority: load>battery>grid

Power supply priority: PV > grid> battery >DG

Supports TOU settings in this mode.

This mode applies to the area where the electricity tariff is calculated according to the maximum power per unit time.

In this mode, on the premise that the power supplied by the grid does not exceed the set value Max. usable Grid Power, the system will strive to charge the battery to Baseline SOC. If “ PV + P-discharge + Max. usable Grid Power < P-load ”, it will exceed the set value (Max. usable Grid Power), by using the stored energy from the battery to power the loads.

### How to set Peak-shaving mode?

A. Peak Shaving Mode App View

B. Define the maximum usable power drawn from the grid.

C. Setting a baseline State of Charge (SOC) for the battery.

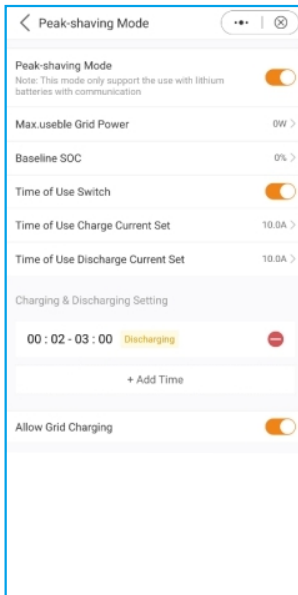

A

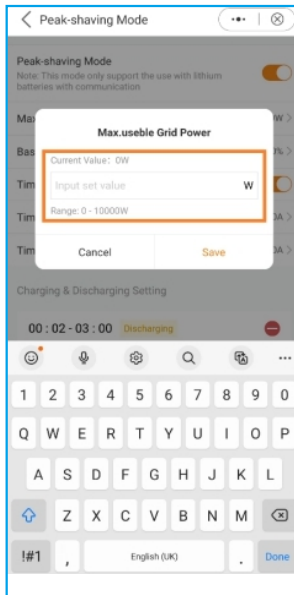

B

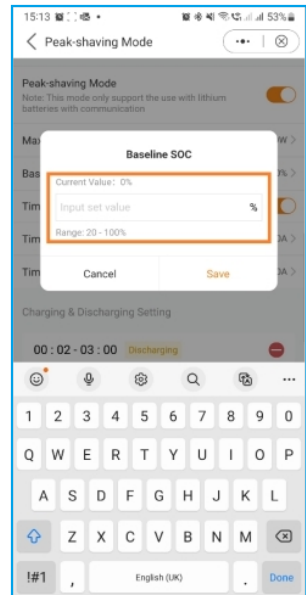

C

As evident in the screenshots, you have the option to configure the charge/discharge current and set charging times when activating the "Time of Use Switch."

## 5.5.4 Off-Grid Mode

Load priority : load>battery

Power supply priority: PV>battery>DG

- This mode applies to the area not covered by the grid or when the system is not connected to the grid.
- When a power outage is detected in a grid-tied system, the system will automatically will automatically enter in the off-grid, supplying only the backup load.
- The user can also manually set this mode, supplying only the backup load.

### How to set Off-Grid mode?

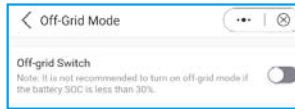

## 5.6 TOU Function Settings

This function applies to the area with peak-valley price. Set the system to charge the battery in valley price and discharge in peak price to improve benefits.

Supports 6 customizable charge/discharge time settings, while the battery will charge/ discharge at a set current.

Supports TOU function settings in self-use mode, feed in priority mode, peak-shaving mode.

There are 6 customizable charging settings and 6 customizable discharging settings.

How to set TOU Function?

- Set a charging/discharging time period.
- Set a SOC(1~6) value for the battery. This is the cut-off SOC for charging or discharging.
- Set a charge/discharge current(1~6),this is the maximum charging and discharging current.
- Press“+Add Time”to add a charging/discharging time period.

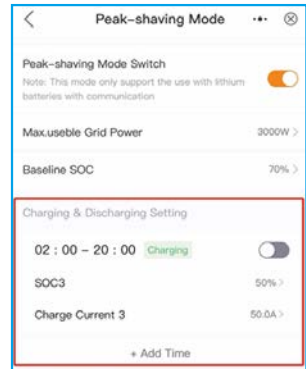
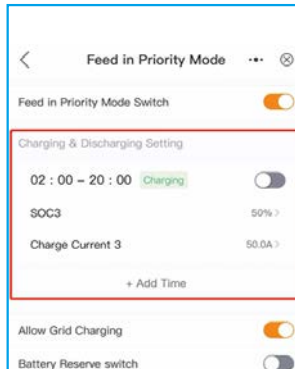

## 5.7 Battery Settings

The battery section of the app offers numerous options to customize the interaction between the inverter and the battery. Here, we provide explanations for the functions and features available in this section, allowing users to tailor the inverter's behavior to their specific preferences and requirements.

**Battery Mode:** Please select the correct model of the battery. If you don't have a battery, choose "No battery" to ensure accurate configuration.

**Max Charging/Discharging Current:** Choose the maximum charge/discharge current that you wish to. This selection allows you to customize the charging and discharging parameters based on your preferences and requirements.

**Overdischarge SOC:** The Overdischarge SOC (State of Charge) is the minimum battery charge level to which the inverter will discharge. It acts as a safeguard to prevent the battery from discharging beyond this specified threshold, ensuring its longevity and health.

**Overdischarge Hysteresis SOC:** The Overdischarge Hysteresis SOC is a hysteresis threshold that prevents the battery from frequently switching between charging and discharging nearby the Overdischarge SOC.

**Forcecharge SOC:** The Forcecharge SOC for the battery is the minimum state of charge (SOC) at which the inverter initiates charging the battery from the grid. It specifies the threshold below which the inverter actively engages in recharging the battery to maintain optimal performance.

**Peak-shaving setting:** If the switch is enable, the power of force charging will be dynamically adjusted. (see below for example)

**Max Grid power when Force charging:** During Forcecharge activation, users have the option to set the maximum power utilized by the grid. This feature allows for customization of the power limit, ensuring control over the amount of energy drawn from the grid during the charging process. (Peak-shaving needs to be activated)

**ECO Function:** If PV power is lower than 100W and SOC falls below overdischarge SOC, the inverter will turn off the grid relays and IGBT switching. If forcecharge SOC is reached, it will connect back to grid and charge battery back to overdischarge SOC, then turn off again.

**Battery Wakeup Switch:** After Battery wake up command, the inverter powers the DC battery port using Battery Wakeup Voltage and low AMP till BMS communication of battery will be restored and within awaken time.

**Auto Bat Awaken:** Automatically trigger the battery wake up every time in the morning when inverter starts up.

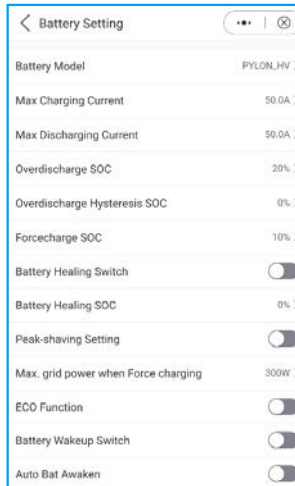

Example Peak Shaving setting:

If the switch is enable, the power of force charging will be dynamically adjusted.

Few samples to be clear: (Forcecharge Limited Power Setting=4kW)

If the load=3kW,PV=0kW, $P_{forcecharge}=P_{Grid}(4kW)-P_{Load}(3kW)=1kW$ .

If the load=10kW,PV=0kW, $P_{forcecharge}=0kW,P_{Grid}=P_{Load}=10kW$ .

## 5.8 Battery Healing Switch

When the lithium battery maintains low power for a long time, the battery SOC measurement is not accurate. Battery healing function will charge the battery from low power level to battery healing SOC to ensure the healthy and stable operation of the battery.

A Enable Battery Healing Switch

B Set Battery Healing SOC

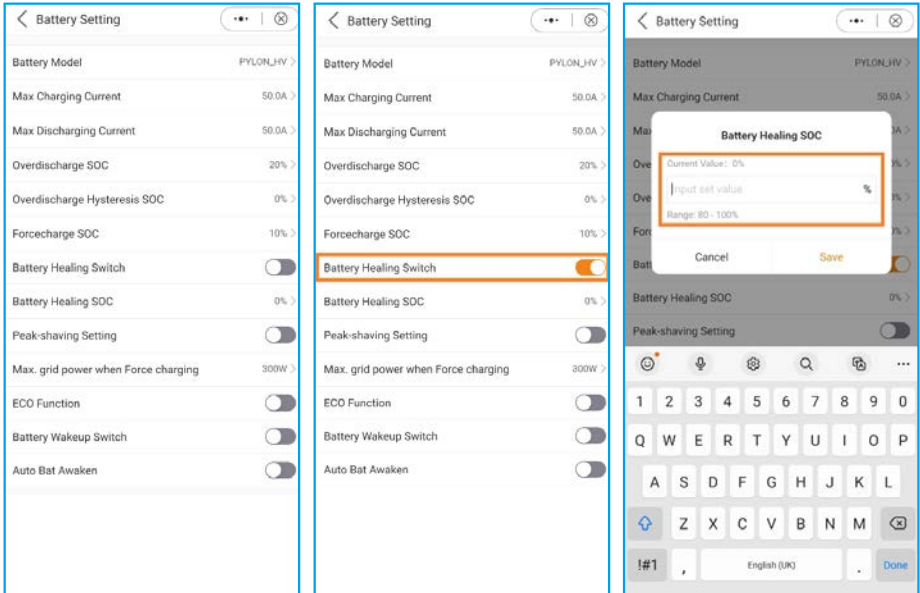

## 5.9 Battery Reserve Function Settings

This function applies to the area that has frequent power outages, to ensure that the battery has enough energy to supply the loads when the grid is not available.

How to set Battery Reserve Function?

Supports Battery Reserve Function settings in self-use mode, feed in priority mode.

A Enable "Battery Reserve switch".

B Set "Reserved SOC" value ,the system will charge the battery to "Reserved SOC".

C Set "Grid Charging Power Limit" value, the charge power from grid will not exceed this value.

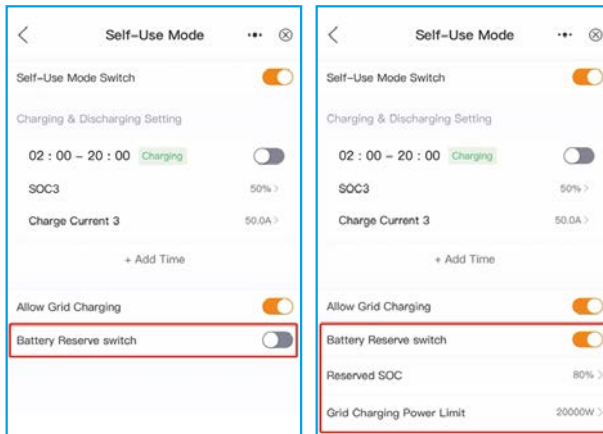



## 5.10 Feed in power limit function

This mode applies to the area that has export control.

To restrict the export of power from the inverter, customers can utilize the internal EPM (Export Power Limit) function. Through the app, users have the flexibility to easily adjust various settings, enabling them to control the amount of power exported to the grid. This feature provides a convenient way for users to manage and limit the exported power based on their preferences and requirements.

Grid Feed in Power Limit view: You have the flexibility to limit the feed-in of either power or current.

Unbalanced Output: If this is set to "On," it will support different power feed-in power limitation on each phase line.

If it's set to "Off," it will equalize on all three phases. (Feed in power only).

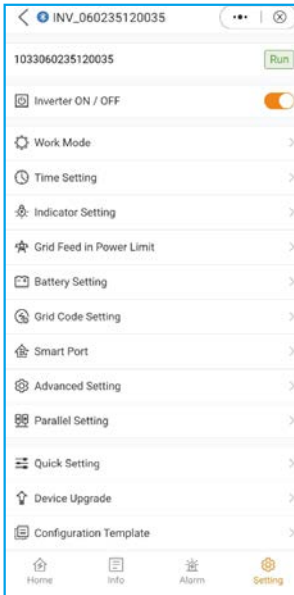

General Settings view

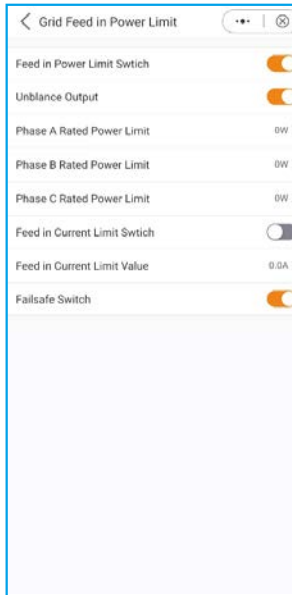

Grid Feed in Power Limit view

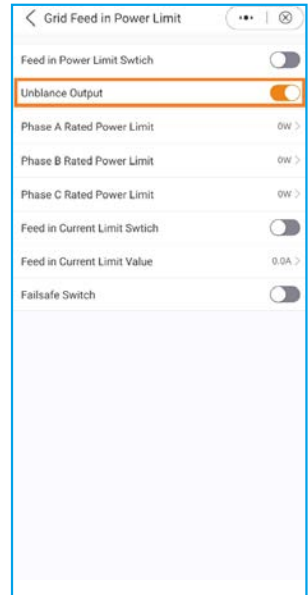

Unbalanced Output

Once you activate the Feed in Power limit switch, you have the possibility to set the power limit for each phase individually.

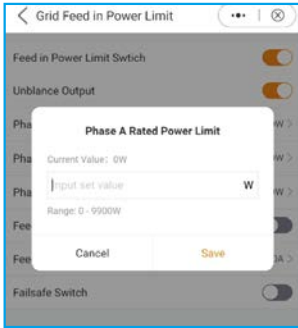

Phase A

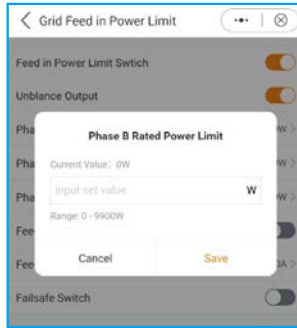

Phase B

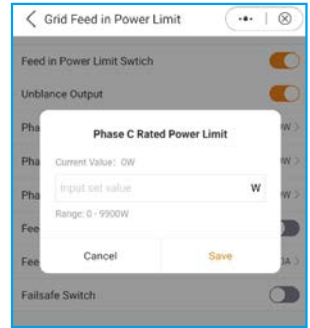

Phase C

### Feed in Current Limiting:

In addition to limiting the power, you have also the option to limit the current only.

### Failsafe Switch:

When this setting is enabled, the inverter will discontinue power generation if it loses communication with the external meter. In such instances, an alarm code will be displayed on the screen, and if a logger is installed, the information will be logged on SolisCloud. Enabling the failsafe ensures that no power is exported to the grid, providing an additional layer of control and safety in case of communication interruptions.

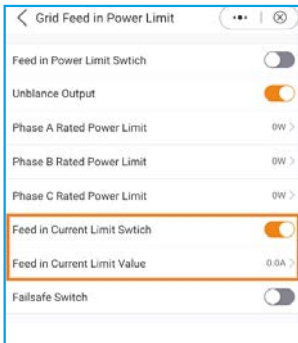

Feed in Current Limit settings

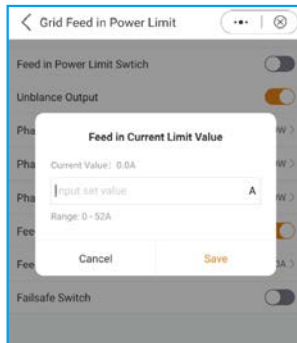

Feed in Current Limit Value

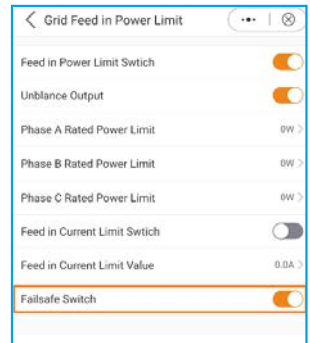

Failsafe Switch

## 5.11 Parallel Settings

Set up a parallel system according to the following steps :

- A. Set the parallel mode as “Parallel”.
- B. Set the master inverter address ID to 1, the other slaves to 2~6.  
(Note: the address ID cannot be set to 0, and the physical address of the master must be 1 )
- C. Choose “master” or “slave” for each inverter.
- D. Choose the number of inverters in parallel, the range is 2~6.
- E. Enable “Parallel Sync” , parameters of the main inverter will be synchronized to the slaves.
- F. DIP Switch:

Option 1: Both the first and the last inverter(INV1 & INV3) have 1 of the DIP switch enabled.

(Either Pin1 & Pin2)

Option 2: One of the first and the last inverter (INV1 or INV3) has 2 DIP switches enabled.

(Both Pin1 or Pin2)

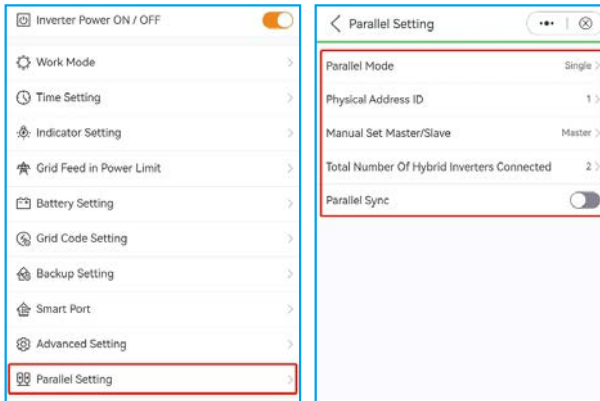

## 5.12 Smart port settings

### 5.12.1 AC Coupling setting

- A. Enable the "AC Coupling Switch".
- B. Choose the actual position of grid-tied inverter , "Backup port" or "Generator port".
- C. Set "AC Coupling\_ON\_SOC" , the range is "0%~100%" , when the battery SOC drops to the set value, the grid-tied inverter start output.
- D. Set "Start Frequency" , the default value is local standard frequency.
- E. Set "AC Coupling\_OFF\_SOC" , the range is "0%~100%" , when the battery SOC reaches the set value, the system will restrict the output power of grid-tied inverter to 0.
- F. Set "AC Coupling Max.fre" , the default value is the local standard over\_frequency  $\pm 0.1\text{HZ}$ , which does not need to be changed.



**NOTE:**

Step C ~Step F are only effective in pure off- grid without generator scenario.



## 5.12.2 Generator setting

- A. Enable "With Generator".
- B. Set "GEN Rated power".
- C. Set "GEN max charge power".
- D. Select the actual position of generator, "Grid port" or "Generator port".
- E. Set "GEN\_Start\_SOC" and "GEN\_Exit\_SOC" for lithium battery. ("GEN\_Start\_Volt" and "GEN\_Exit\_Volt" for lead-acid battery)
- F. Enable "Gen signal" the generator is controlled by the inverter to start and stop, do not enable this option, the start and stop of generator will require manual operation.
- G. Enable "Gen Force" means remote forced start of generator.
- H. Enable "Gen Stop" means remote forced stop of generator.



**NOTE:**

For remote control of the generator, it is necessary to correctly connect the control signal cable, and the generator needs to support the control logic of the inverter.



## 5.13 CT Detection function

Before the customers operate CT detection function, they should make sure the pre-condition is ready for the detection

1. No PV connected with inverter, you can choose disconnect all DC wire or turn off the DC switch of the machine.
2. No load, No load connected with inverter or all load connected with inverter have been offline.
3. You can connect the battery with inverter, but the power of discharging to grid or charging by grid MUST less than or equal to 3KW.
4. The inverter is running with grid without any fault.
5. You should install the meter on the grid side.
6. According to the CT installation situation on site, the default direction for it is toward power grid, if you put it on reversed direction. Just choose the configuration parameter: backward on the APP interface.

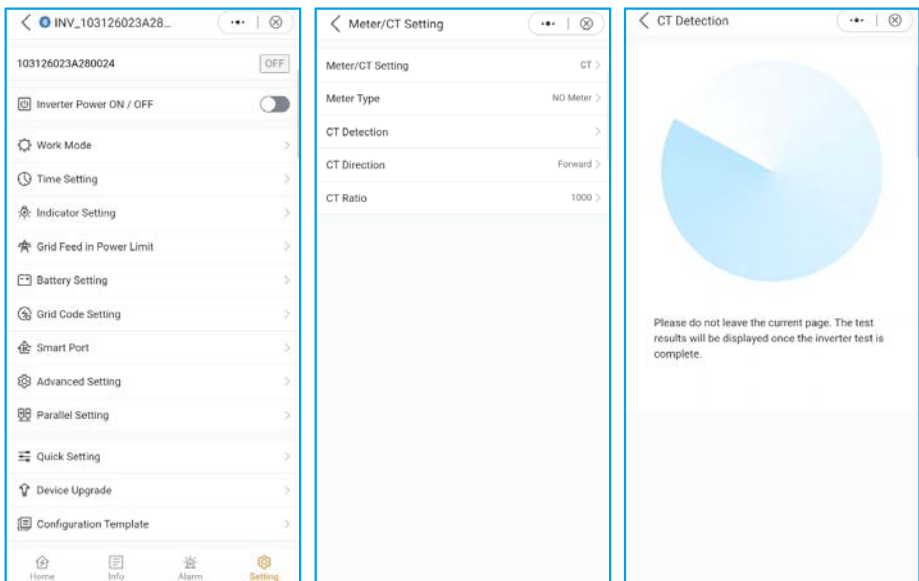

The results of CT Detection function:

- Unable Check (The onsite condition does not meet the CT detection conditions, you should check the above condition)
- CT Normal (CT detection is normal)
- CT Fault (CT detection is abnormal, you should check CT itself or other things)

## 5.14 Only PV power load function

### 1. Function Definition

For PV generation is not stable, the default setting of S6 energy storage machine don't support only PV power the load.

But for meeting the some customers' special requirements, we develop the **Only PV Power Load** function, when the PV power > the load power, you can use this function.

Because the PV power is not stable and the load is also not always stable, it is possible to happen that PV power < load power, when it occurred, the load will shut down and **after 3 minutes**, the inverter tries to restart the load for the first time, **after 5 minutes**, the second time, and **after 10 minutes**, the third time. If the third attempt to restart the load is still not successful, the inverter will not try to restart, and it needs to be manually reset and restarted.



#### NOTE:

1. Only PV Power Load function is closed by default. If you need to use it, you need to open it by yourself.
2. Software: Ensure that the current DSP and HMI software is the latest version, ensure that the version is the following version and higher version:  
S6-EH3P (5-10)K-H: DSP:V02B70 , ARM: V0E-02  
S6-EH3P (12-20)K-H: The official software has not been released yet.

### 2. Solis APP Setting

1. Open your Solis APP, and go to the Setting->Advanced Setting->**Only PV power Load**
2. Manually reset the switch after the load is turned off: APP-> Settings -> Advanced Settings -> **PV Only Overload Reset**

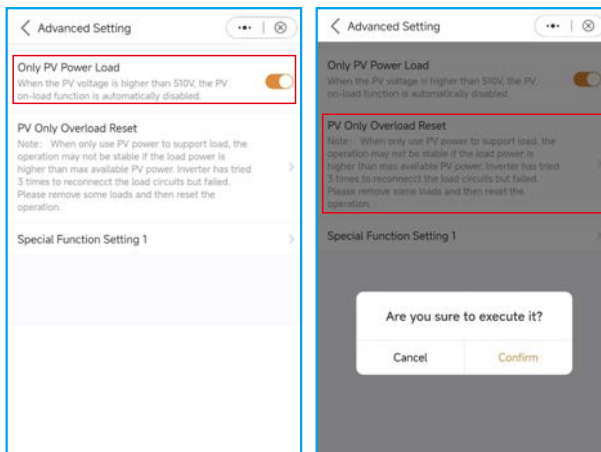

Solis S6 Series inverter does not require any regular maintenance. However, cleaning the heatsink will help inverter dissipating heat and increase the lifetime of inverter. The dirt on the inverter can be cleaned with a soft brush.



**CAUTION:**

Do not touch the surface when the inverter is operating. Some parts may be hot and cause burns. Turn OFF the inverter and let it cool down before you do any maintenance or cleaning of inverter.

The Intelligent LED indicators can be cleaned with cloth if they are too dirty.



**NOTE:**

Never use any solvents, abrasives or corrosive materials to clean the inverter.



Message Name	Information Description	Troubleshooting Suggestion
Off	Control device to shutdown	1. Turn on the device in the ON/OFF Setting.
LmtByEPM	The device's output is under controlled	<ol style="list-style-type: none"> <li>1. Confirm whether the inverter is connected to an external EPM/meter to prevent reverse current.</li> <li>2. Confirm whether the inverter is controlled by an external third-party device.</li> <li>3. Confirm whether the power setting of the inverter power control is limited.</li> <li>4. Verify settings in section 6.6.7 and check your meter readings.</li> </ol>
LmtByDRM	DRM Function ON	1. No need to deal with it.
LmtByTemp	Over temperature power limited	1. No need to deal with it, the device is in normal operation.
LmtByFreq	Frequency power limited	
LmtByVg	The device is in the Volt-Watt mode	<ol style="list-style-type: none"> <li>1. Due to the requirements of local safety regulations, when the grid voltage is high, the Volt-watt working mode is triggered, which generally does not need to be dealt with.</li> <li>2. This mode is enabled by default.</li> </ol>
LmtByVar	The device is in the Volt-Var mode of operation	<ol style="list-style-type: none"> <li>1. Due to the requirements of local safety regulations, when the grid voltage is high, the Volt-watt working mode is triggered, which generally does not need to be dealt with.</li> <li>2. This mode is enabled by default.</li> </ol>
LmtByUnFr	Under frequency limit	1. No need to deal with it.
Standby	Bypass run	
StandbySynoch	Off grid status to On grid status	
GridToLoad	Grid to load	

# 7. Troubleshooting

Message Name	Information Description	Troubleshooting Suggestion
Surge Alarm	On-site grid surge	1. Grid side fault, restart the device. If it is still not eliminated, please contact the manufacturer's customer service.
OV-G-V01	Grid voltage exceeds the upper voltage range	1. Confirm whether the power grid is abnormal. 2. Confirm that the AC cable is properly connected. 3. Restart the system and check if the fault persists.
UN-G-V01	Grid voltage exceeds the lower voltage range	
OV-G-F01	Grid frequency exceeds the upper frequency range	
UN-G-F01	Grid frequency exceeds the lower frequency range	
G-PHASE	Unbalanced grid voltage	
G-F-GLU	Grid voltage frequency fluctuation	
NO-Grid	No grid	
OV-G-V02	Grid transient overvoltage	
OV-G-V03	Grid transient overvoltage	1. Restart the system, confirm if that the fault continues.
IGFOL-F	Grid current tracking failure	1. Confirm whether the power grid is abnormal. 2. Confirm that the AC cable is properly connected. 3. Restart the system and check if the fault persists.
OV-G-V05	Grid voltage RMS instantaneous overvoltage fault	
OV-G-V04	Grid voltage exceeds the upper voltage range	
UN-G-V02	Grid voltage exceeds the lower voltage range	
OV-G-F02	Grid frequency exceeds the upper frequency range	
UN-G-F02	Grid frequency exceeds the lower frequency range	
NO-Battery	Battery is not connected	1. Check on information page 1 – Verify the battery voltage is within standards. 2. Measure battery voltage at plug.
OV-Vbackup	Inverting overvoltage	1. Check whether the backup port wiring is normal 2. Restart the system, confirm that the fault continues.
Over-Load	Load overload fault	1. Backup load power is too large, or some inductive load startup power is too large, need to remove some backup load, or remove the inductive load on the backup.

Message Name	Information Description	Troubleshooting Suggestion
BatName-FAIL	Wrong battery brand selection	1. Confirm whether the battery model selection is consistent with the actual one.
CAN Fail	CAN Fail	1. Can failure is a failure of communication between inverter and battery. Check cable conditions. Check to ensure you have it plugged in on the CAN port of the battery and inverter. Check that you are using the right cable. Some batteries require a special battery from the battery manufacturer.
OV-Vbatt	Battery overvoltage detected	1. Verify battery voltage is within standards. Measure battery voltage at inverter connection point. Contact your battery manufacturer for further service.
UN-Vbatt	Battery undervoltage detected	1. Restart the system and check if the fault persists. If it is still not eliminated, please contact the manufacturer's customer service.
Fan Alarm	Fan alarm	1. Check if the internal fan is working correctly or jammed.
OV-DC01 (1020 DATA:0001)	DC 1 input overvoltage	1. Check if the PV voltage is abnormal 2. Restart the system, confirm that the fault continues
OV-DC02 (1020 DATA:0002)	DC 2 input overvoltage	
OV-BUS (1021 DATA:0000)	DC bus overvoltage	1. Restart the system, confirm that the fault continues.
UN-BUS01 (1023 DATA:0001)	DC bus undervoltage	
UNB-BUS (1022 DATA:0000)	DC bus unbalanced voltage	
UN-BUS02 (1023 DATA:0002)	Abnormal detection of DC bus voltage	
DC-INTF. (1027 DATA:0000)	DC hardware overcurrent (1, 2, 3, 4)	1. Check if the DC wires are connected correctly without loose connection.
OV-G-I (1018 DATA:0000)	Aphase RMS value overcurrent	1. Confirm that the grid is abnormal. 2. Confirm that the AC cable connection is not abnormal. 3. Restart the system, confirm that the fault continues.
OV-DCA-I (1025 DATA:0000)	DC 1 average overcurrent	1. Restart the system, confirm that the fault continues.
OV-DCB-I (1026 DATA:0000)	DC 2 average overcurrent	
GRID-INTF. (1030 DATA:0000)	AC hardware overcurrent (abc phase)	

Message Name	Information Description	Troubleshooting Suggestion
DCInj-FAULT (1037 DATA:0000)	The current DC component exceeds the limit	<ol style="list-style-type: none"> <li>1. Confirm that the grid is abnormal.</li> <li>2. Confirm that the AC cable connection is not abnormal.</li> <li>3. Restart the system, confirm that the fault continues.</li> </ol>
IGBT-OV-I (1048 DATA:0000)	IGBT overcurrent	<ol style="list-style-type: none"> <li>1. Restart the system, confirm that the fault continues.</li> </ol>
OV-TEM (1032 DATA:0000)	Module over temperature	<ol style="list-style-type: none"> <li>1. Check whether the surrounding environment of the inverter has poor heat dissipation.</li> <li>2. Confirm whether the product installation meets the requirements.</li> </ol>
RelayChk-FAIL (1035 DATA:0000)	Relay failure	<ol style="list-style-type: none"> <li>1. Restart the system, confirm that the fault continues.</li> </ol>
UN-TEM (103A DATA:0000)	Low temperature protection	<ol style="list-style-type: none"> <li>1. Check the working environment temperature of the inverter.</li> <li>2. Restart the system to confirm if the fault continues.</li> </ol>
PV ISO-PRO01 (1033 DATA:0001)	PV negative ground fault	<ol style="list-style-type: none"> <li>1. Check whether the PV strings have insulation problems.</li> <li>2. Check whether the PV cable is damaged.</li> </ol>
PV ISO-PRO02 (1033 DATA:0002)	PV positive ground fault	
12Power-FAULT (1038 DATA:0000)	12V undervoltage failure	<ol style="list-style-type: none"> <li>1. Check current leakage to ground. Verify your grounding. Verify all wires are in good condition and not leaking current to ground.</li> </ol>
ILeak-PRO01 (1034 DATA:0001)	Leakage current failure 01 (30mA)	
ILeak-PRO02 (1034 DATA:0002)	Leakage current failure 02 (60mA)	
ILeak-PRO03 (1034 DATA:0003)	Leakage current failure 03 (150mA)	
ILeak-PRO04 (1034 DATA:0004)	Leakage current failure 04	
ILeak_Check (1039 DATA:0000)	Leakage current sensor failure	
GRID-INTF02 (1046 DATA:0000)	Power grid disturbance 02	<ol style="list-style-type: none"> <li>1. Confirm whether the grid is seriously distorted.</li> <li>2. Check whether the AC cable is connected reliably.</li> </ol>
OV-Vbatt-H/ OV-BUS-H (1051 DATA:0000)	Battery overvoltage hardware failure / VBUS	<ol style="list-style-type: none"> <li>1. Check if the battery circuit breaker is tripping.</li> <li>2. Check if the battery is damaged.</li> </ol>

Message Name	Information Description	Troubleshooting Suggestion
OV-ILLC (1052 DATA:0000)	LLC hardware overcurrent	1. Check whether the backup load is overloaded. 2. Restart the system, confirm that the fault continues.
INI-FAULT (1031 DATA:0000)	AD zero drift overlink	1. Restart the system, confirm that the fault continues.
DSP-B-FAULT (1036 DATA:0000)	The master-slave DSP communication is abnormal	
AFCI-Check (1040 DATA:0000)	AFCI self-test failure	
ARC- FAULT (1041 DATA:0000)	AFCI failure	1. Verify connections are tight within your PV system. Arc fault settings can be changed in advanced settings if further adjustment is necessary.

Table 7.1 Fault message and description



**NOTE:**

If the inverter displays any alarm message as listed in Table 7.1; please turn off the inverter and wait for 5 minutes before restarting it .  
If the failure persists, please contact your local distributor or the service center.

Please keep ready with you the following information before contacting us.

1. Serial number of Solis three phase inverter;
2. The distributor/dealer of Solis three phase inverter (if available);
3. Installation date.
4. The description of the problem together with necessary information, pictures, attachment.
5. The PV array configuration (e.g. number of panels, capacity of panels, number of strings, etc.);
6. Battery details (brand, model, capacity, data connection, etc.).
7. Your contact details.

# 8. Specifications

Technical Data	S6-EH3P12K-ND-H
<b>Input DC (PV side)</b>	
Max Usable PV Input Power	19200W
Max. input voltage	1000V
Rated voltage	600V
Start-up voltage	160V
MPPT voltage range	200-850V
Full load MPPT voltage range	300-850V
Max. input current	4*20A
Max. short circuit current	4*30A
MPPT number/Max input strings number	4/4
<b>Battery</b>	
Battery Type	Li-ion
Battery Voltage range	120 - 800Vdc
Maximum charging Power	12kW
Maximum Charge/discharge current	50A
Communication	CAN/RS485
<b>Output AC(Grid-side)</b>	
Rated output power	12kW
Max. apparent output power	12kVA
Rated grid voltage	3/N/PE, 380V/400V
The grid voltage range	320-460V
Rating grid frequency	50 Hz/60 Hz
AC grid frequency range	45-55 Hz/ 55-65Hz
Rating grid output current	18.2A/17.3A
Max. output current	18.2A/17.3A
Power factor	> 0.99 ( 0.8 leading to 0.8 lagging)
THDi	< 3%
<b>Input AC(Grid-side)</b>	
Max. input power	18kW
Rated input current	27.3A/26.0A
Rated input voltage	3/N/PE, 380V/400V
Rated input frequency	50 Hz/60 Hz

# 8. Specifications

Technical Data	S6-EH3P12K-ND-H
<b>Input Generator</b>	
Max. input power	12kW
Rated input current	18.2A/17.3A
Rated input frequency	50 Hz/60 Hz
<b>Output AC(Back-up)</b>	
Rated output power	12kW
Peak apparent output power	2 time of rated power, 10 S
Back-up switch time	< 10ms
Rated output voltage	3/N/PE, 380V/400V
Rated frequency	50 Hz/60 Hz
Rated output current	18.2A/17.3A
THDv(@linear load)	<3%
<b>Efficiency</b>	
Max. efficiency	97.7%
EU efficiency	97.5%
BAT charged by PV Max. efficiency	98.5%
BAT charged/discharged to AC Max. efficiency	97.2%
MPPT efficiency	99.9%
<b>Protection</b>	
Anti-islanding protection	Yes
Output over voltage protection	Yes
Insulation resistance monitoring	Yes
Residual current detection	Yes
Output over current protection	Yes
Short circuit protection	Yes
Integrated AFCI 2.0	Optional
Integrated DC switch	Yes
DC reverse polarity protection	Yes
PV overvoltage protection	Yes
Battery reverse protection	Yes

# 8. Specifications

Technical Data	S6-EH3P12K-ND-H
<b>General data</b>	
Max. allowable phase imbalance (grid & back up)	100%
Max. power per phase (grid & back up)	50% rated power
Dimensions(W/H/D)	563*546*235mm
Weight	32.6kg
Topology	Transformerless
Self consumption (Night)	<25 W
Operation temperature range	-25°C ~ +60°C
Relative humidity	0-95%
Ingress protection	IP66
Noise emission	<65 dB(A)
Cooling concept	Smart cooling
Max.operation altitude	2000m
Grid connection standard	EN 50549-1, VDE4105 CEI 0-21, CEI 0-16, NC-RFG TypeB, NRS 097-2-1 ED 2.1
Safety/EMC standard	IEC/EN 62109-1/-2, IEC/EN 61000-6-1/-3, IEC 61000-2
<b>Features</b>	
PV connection	MC4 connector
Battery connection	Latched type plug
AC connection	Latched type plug
Display	LED + Bluetooth + APP
Communication	CAN, RS485, Ethernet, optional:Wi-Fi, Cellular, LAN
Warranty	5 years (extendable to 20 years)



# 8. Specifications

Technical Data	S6-EH3P15K-ND-H
<b>Input DC (PV side)</b>	
Max Usable PV Input Power	24000W
Max. input voltage	1000V
Rated voltage	600V
Start-up voltage	160V
MPPT voltage range	200-850V
Full load MPPT voltage range	300-850V
Max. input current	4*20A
Max. short circuit current	4*30A
MPPT number/Max input strings number	4/4
<b>Battery</b>	
Battery Type	Li-ion
Battery Voltage range	120 - 800Vdc
Maximum charging Power	15kW
Maximum Charge/discharge current	50A
Communication	CAN/RS485
<b>Output AC(Grid-side)</b>	
Rated output power	15kW
Max. apparent output power	15kVA
Rated grid voltage	3/N/PE, 380V/400V
The grid voltage range	320-460V
Rating grid frequency	50 Hz/60 Hz
AC grid frequency range	45-55 Hz/ 55-65Hz
Rating grid output current	22.8A/21.7A
Max. output current	22.8A/21.7A
Power factor	> 0.99 ( 0.8 leading to 0.8 lagging)
THDi	< 3%
<b>Input AC(Grid-side)</b>	
Max. input power	22.5kW
Rated input current	34.2A/32.5A
Rated input voltage	3/N/PE, 380V/400V
Rated input frequency	50 Hz/60 Hz

# 8. Specifications

Technical Data	S6-EH3P15K-ND-H
<b>Input Generator</b>	
Max. input power	15kW
Rated input current	22.8A/21.7A
Rated input frequency	50 Hz/60 Hz
<b>Output AC(Back-up)</b>	
Rated output power	15kW
Peak apparent output power	2 time of rated power, 10 S
Back-up switch time	< 10ms
Rated output voltage	3/N/PE, 380V/400V
Rated frequency	50 Hz/60 Hz
Rated output current	22.8A/21.7A
THDv(@linear load)	<3%
<b>Efficiency</b>	
Max. efficiency	97.7%
EU efficiency	97.5%
BAT charged by PV Max. efficiency	98.5%
BAT charged/discharged to AC Max. efficiency	97.2%
MPPT efficiency	99.9%
<b>Protection</b>	
Anti-islanding protection	Yes
Output over voltage protection	Yes
Insulation resistance monitoring	Yes
Residual current detection	Yes
Output over current protection	Yes
Short circuit protection	Yes
Integrated AFCI 2.0	Optional
Integrated DC switch	Yes
DC reverse polarity protection	Yes
PV overvoltage protection	Yes
Battery reverse protection	Yes

# 8. Specifications

Technical Data	S6-EH3P15K-ND-H
<b>General data</b>	
Max. allowable phase imbalance (grid & back up)	100%
Max. power per phase (grid & back up)	50% rated power
Dimensions(W/H/D)	563*546*235mm
Weight	32.6kg
Topology	Transformerless
Self consumption (Night)	<25 W
Operation temperature range	-25°C ~ +60°C
Relative humidity	0-95%
Ingress protection	IP66
Noise emission	<65 dB(A)
Cooling concept	Smart cooling
Max.operation altitude	2000m
Grid connection standard	EN 50549-1, VDE4105 CEI 0-21, CEI 0-16, NC-RFG TypeB, NRS 097-2-1 ED 2.1
Safety/EMC standard	IEC/EN 62109-1/-2, IEC/EN 61000-6-1/-3, IEC 61000-2
<b>Features</b>	
PV connection	MC4 connector
Battery connection	Latched type plug
AC connection	Latched type plug
Display	LED + Bluetooth + APP
Communication	CAN, RS485, Ethernet, optional:Wi-Fi, Cellular, LAN
Warranty	5 years (extendable to 20 years)

# 8. Specifications

Technical Data	S6-EH3P20K-ND-H
<b>Input DC (PV side)</b>	
Max Usable PV Input Power	32000W
Max. input voltage	1000V
Rated voltage	600V
Start-up voltage	160V
MPPT voltage range	200-850V
Full load MPPT voltage range	300-850V
Max. input current	4*20A
Max. short circuit current	4*30A
MPPT number/Max input strings number	4/4
<b>Battery</b>	
Battery Type	Li-ion
Battery Voltage range	120 - 800Vdc
Maximum charging Power	20kW
Maximum Charge/discharge current	50A
Communication	CAN/RS485
<b>Output AC(Grid-side)</b>	
Rated output power	20kW
Max. apparent output power	20kVA
Rated grid voltage	3/N/PE, 380V/400V
The grid voltage range	320-460V
Rating grid frequency	50 Hz/60 Hz
AC grid frequency range	45-55 Hz/ 55-65Hz
Rating grid output current	30.4A/28.9A
Max. output current	30.4A/28.9A
Power factor	> 0.99 ( 0.8 leading to 0.8 lagging)
THDi	< 3%
<b>Input AC(Grid-side)</b>	
Max. input power	30kW
Rated input current	45.6A/43.3A
Rated input voltage	3/N/PE, 380V/400V
Rated input frequency	50 Hz/60 Hz

# 8. Specifications

Technical Data	S6-EH3P20K-ND-H
<b>Input Generator</b>	
Max. input power	20kW
Rated input current	30.4A/28.9A
Rated input frequency	50 Hz/60 Hz
<b>Output AC(Back-up)</b>	
Rated output power	20kW
Peak apparent output power	1.6 time of rated power, 10 S
Back-up switch time	< 10ms
Rated output voltage	3/N/PE, 380V/400V
Rated frequency	50 Hz/60 Hz
Rated output current	30.4A/28.9A
THDv(@linear load)	<3%
<b>Efficiency</b>	
Max. efficiency	97.7%
EU efficiency	97.5%
BAT charged by PV Max. efficiency	98.5%
BAT charged/discharged to AC Max. efficiency	97.2%
MPPT efficiency	99.9%
<b>Protection</b>	
Anti-islanding protection	Yes
Output over voltage protection	Yes
Insulation resistance monitoring	Yes
Residual current detection	Yes
Output over current protection	Yes
Short circuit protection	Yes
Integrated AFCI 2.0	Optional
Integrated DC switch	Yes
DC reverse polarity protection	Yes
PV overvoltage protection	Yes
Battery reverse protection	Yes

# 8. Specifications

Technical Data	S6-EH3P20K-ND-H
<b>General data</b>	
Max. allowable phase imbalance (grid & back up)	100%
Max. power per phase (grid & back up)	40% rated power
Dimensions(W/H/D)	563*546*235mm
Weight	32.6kg
Topology	Transformerless
Self consumption (Night)	<25 W
Operation temperature range	-25°C ~ +60°C
Relative humidity	0-95%
Ingress protection	IP66
Noise emission	<65 dB(A)
Cooling concept	Smart cooling
Max.operation altitude	2000m
Grid connection standard	EN 50549-1, VDE4105 CEI 0-21, CEI 0-16, NC-RFG TypeB, NRS 097-2-1 ED 2.1
Safety/EMC standard	IEC/EN 62109-1/-2, IEC/EN 61000-6-1/-3, IEC 61000-2
<b>Features</b>	
PV connection	MC4 connector
Battery connection	Latched type plug
AC connection	Latched type plug
Display	LED + Bluetooth + APP
Communication	CAN, RS485, Ethernet, optional:Wi-Fi, Cellular, LAN
Warranty	5 years (extendable to 20 years)

# 8. Specifications

Technical Data	S6-EH3P8K-LV-ND-H
<b>Input DC (PV side)</b>	
Max Usable PV Input Power	12800W
Max. input voltage	1000V
Rated voltage	600V
Start-up voltage	160V
MPPT voltage range	200-850V
Full load MPPT voltage range	300-850V
Max. input current	4*16A
Max. short circuit current	4*24A
MPPT number/Max input strings number	4/4
<b>Battery</b>	
Battery Type	Li-ion
Battery Voltage range	120 - 800Vdc
Maximum charging Power	8kW
Maximum Charge/discharge current	50A
Communication	CAN/RS485
<b>Output AC(Grid-side)</b>	
Rated output power	8kW
Max. apparent output power	8kVA
Rated grid voltage	3/N/PE, 230V
The grid voltage range	195-265V
Rating grid frequency	50 Hz/60 Hz
AC grid frequency range	45-55 Hz/ 55-65Hz
Rating grid output current	20.1A
Max. output current	20.1A
Power factor	> 0.99 ( 0.8 leading to 0.8 lagging)
THDi	< 3%
<b>Input AC(Grid-side)</b>	
Max. input power	12kW
Rated input current	30.1A
Rated input voltage	3/N/PE, 230V
Rated input frequency	50 Hz/60 Hz

# 8. Specifications

Technical Data	S6-EH3P8K-LV-ND-H
<b>Input Generator</b>	
Max. input power	8kW
Rated input current	20.1A
Rated input frequency	50 Hz/60 Hz
<b>Output AC(Back-up)</b>	
Rated output power	8kW
Peak apparent output power	2 time of rated power, 10 S
Back-up switch time	< 10ms
Rated output voltage	3/N/PE, 230V
Rated frequency	50 Hz/60 Hz
Rated output current	20.1A
THDv(@linear load)	<2%
<b>Efficiency</b>	
Max. efficiency	97.7%
EU efficiency	97.5%
BAT charged by PV Max. efficiency	98.5%
BAT charged/discharged to AC Max. efficiency	97.2%
MPPT efficiency	99.9%
<b>Protection</b>	
Anti-islanding protection	Yes
Output over voltage protection	Yes
Insulation resistance monitoring	Yes
Residual current detection	Yes
Output over current protection	Yes
Short circuit protection	Yes
Integrated AFCI 2.0	Optional
Integrated DC switch	Yes
DC reverse polarity protection	Yes
PV overvoltage protection	Yes
Battery reverse protection	Yes



# 8. Specifications

Technical Data	S6-EH3P8K-LV-ND-H
<b>General data</b>	
Max. allowable phase imbalance (grid & back up)	100%
Max. power per phase (grid & back up)	50% rated power
Dimensions(W/H/D)	563*546*235mm
Weight	32.6kg
Topology	Transformerless
Self consumption (Night)	<25 W
Operation temperature range	-25°C ~ +60°C
Relative humidity	0-95%
Ingress protection	IP66
Noise emission	<65 dB(A)
Cooling concept	Smart cooling
Max.operation altitude	2000m
Grid connection standard	VDE4105, REN342, EN5049, C10/11
Safety/EMC standard	IEC/EN 62109-1/-2, IEC/EN 61000-6-1/-3
<b>Features</b>	
PV connection	MC4 connector
Battery connection	Latched type plug
AC connection	Latched type plug
Display	LED + Bluetooth + APP
Communication	CAN, RS485, Ethernet, optional:Wi-Fi, Cellular, LAN
Warranty	5 years (extendable to 20 years)

# 8. Specifications

Technical Data	S6-EH3P10K-LV-ND-H
<b>Input DC (PV side)</b>	
Max Usable PV Input Power	16000W
Max. input voltage	1000V
Rated voltage	600V
Start-up voltage	160V
MPPT voltage range	200-850V
Full load MPPT voltage range	300-850V
Max. input current	4*16A
Max. short circuit current	4*24A
MPPT number/Max input strings number	4/4
<b>Battery</b>	
Battery Type	Li-ion
Battery Voltage range	120 - 800Vdc
Maximum charging Power	10kW
Maximum Charge/discharge current	50A
Communication	CAN/RS485
<b>Output AC(Grid-side)</b>	
Rated output power	10kW
Max. apparent output power	10kVA
Rated grid voltage	3/N/PE, 230V
The grid voltage range	195-265V
Rating grid frequency	50 Hz/60 Hz
AC grid frequency range	45-55 Hz/ 55-65Hz
Rating grid output current	25.1A
Max. output current	25.1A
Power factor	> 0.99 ( 0.8 leading to 0.8 lagging)
THDi	< 3%
<b>Input AC(Grid-side)</b>	
Max. input power	15kW
Rated input current	37.7A
Rated input voltage	3/N/PE, 230V
Rated input frequency	50 Hz/60 Hz

# 8. Specifications

Technical Data	S6-EH3P10K-LV-ND-H
<b>Input Generator</b>	
Max. input power	10kW
Rated input current	25.1A
Rated input frequency	50 Hz/60 Hz
<b>Output AC(Back-up)</b>	
Rated output power	10kW
Peak apparent output power	2 time of rated power, 10 S
Back-up switch time	< 10ms
Rated output voltage	3/N/PE, 230V
Rated frequency	50 Hz/60 Hz
Rated output current	25.1A
THDv(@linear load)	<2%
<b>Efficiency</b>	
Max. efficiency	97.7%
EU efficiency	97.5%
BAT charged by PV Max. efficiency	98.5%
BAT charged/discharged to AC Max. efficiency	97.2%
MPPT efficiency	99.9%
<b>Protection</b>	
Anti-islanding protection	Yes
Output over voltage protection	Yes
Insulation resistance monitoring	Yes
Residual current detection	Yes
Output over current protection	Yes
Short circuit protection	Yes
Integrated AFCI 2.0	Optional
Integrated DC switch	Yes
DC reverse polarity protection	Yes
PV overvoltage protection	Yes
Battery reverse protection	Yes

# 8. Specifications

Technical Data	S6-EH3P10K-LV-ND-H
<b>General data</b>	
Max. allowable phase imbalance (grid & back up)	100%
Max. power per phase (grid & back up)	50% rated power
Dimensions(W/H/D)	563*546*235mm
Weight	32.6kg
Topology	Transformerless
Self consumption (Night)	<25 W
Operation temperature range	-25°C ~ +60°C
Relative humidity	0-95%
Ingress protection	IP66
Noise emission	<65 dB(A)
Cooling concept	Smart cooling
Max.operation altitude	2000m
Grid connection standard	VDE4105, REN342, EN5049, C10/11
Safety/EMC standard	IEC/EN 62109-1/-2, IEC/EN 61000-6-1/-3
<b>Features</b>	
PV connection	MC4 connector
Battery connection	Latched type plug
AC connection	Latched type plug
Display	LED + Bluetooth + APP
Communication	CAN, RS485, Ethernet, optional:Wi-Fi, Cellular, LAN
Warranty	5 years (extendable to 20 years)

# 8. Specifications

Technical Data	S6-EH3P12K-LV-ND-H
<b>Input DC (PV side)</b>	
Max Usable PV Input Power	19200W
Max. input voltage	1000V
Rated voltage	600V
Start-up voltage	160V
MPPT voltage range	200-850V
Full load MPPT voltage range	300-850V
Max. input current	4*20A
Max. short circuit current	4*30A
MPPT number/Max input strings number	4/4
<b>Battery</b>	
Battery Type	Li-ion
Battery Voltage range	120 - 800Vdc
Maximum charging Power	12kW
Maximum Charge/discharge current	50A
Communication	CAN/RS485
<b>Output AC(Grid-side)</b>	
Rated output power	12kW
Max. apparent output power	12kVA
Rated grid voltage	3/N/PE, 230V
The grid voltage range	195-265V
Rating grid frequency	50 Hz/60 Hz
AC grid frequency range	45-55 Hz/ 55-65Hz
Rating grid output current	30.1A
Max. output current	30.1A
Power factor	> 0.99 ( 0.8 leading to 0.8 lagging)
THDi	< 3%
<b>Input AC(Grid-side)</b>	
Max. input power	18kW
Rated input current	45.2A
Rated input voltage	3/N/PE, 230V
Rated input frequency	50 Hz/60 Hz

# 8. Specifications

Technical Data	S6-EH3P12K-LV-ND-H
<b>Input Generator</b>	
Max. input power	12kW
Rated input current	30.1A
Rated input frequency	50 Hz/60 Hz
<b>Output AC(Back-up)</b>	
Rated output power	12kW
Peak apparent output power	1.6 time of rated power, 10 S
Back-up switch time	< 10ms
Rated output voltage	3/N/PE, 230V
Rated frequency	50 Hz/60 Hz
Rated output current	30.1A
THDv(@linear load)	<2%
<b>Efficiency</b>	
Max. efficiency	97.7%
EU efficiency	97.5%
BAT charged by PV Max. efficiency	98.5%
BAT charged/discharged to AC Max. efficiency	97.2%
MPPT efficiency	99.9%
<b>Protection</b>	
Anti-islanding protection	Yes
Output over voltage protection	Yes
Insulation resistance monitoring	Yes
Residual current detection	Yes
Output over current protection	Yes
Short circuit protection	Yes
Integrated AFCI 2.0	Optional
Integrated DC switch	Yes
DC reverse polarity protection	Yes
PV overvoltage protection	Yes
Battery reverse protection	Yes

# 8. Specifications

Technical Data	S6-EH3P12K-LV-ND-H
<b>General data</b>	
Max. allowable phase imbalance (grid & back up)	100%
Max. power per phase (grid & back up)	40% rated power
Dimensions(W/H/D)	563*546*235mm
Weight	32.6kg
Topology	Transformerless
Self consumption (Night)	<25 W
Operation temperature range	-25°C ~ +60°C
Relative humidity	0-95%
Ingress protection	IP66
Noise emission	<65 dB(A)
Cooling concept	Smart cooling
Max.operation altitude	2000m
Grid connection standard	VDE4105, REN342, EN5049, C10/11
Safety/EMC standard	IEC/EN 62109-1/-2, IEC/EN 61000-6-1/-3
<b>Features</b>	
PV connection	MC4 connector
Battery connection	Latched type plug
AC connection	Latched type plug
Display	LED + Bluetooth + APP
Communication	CAN, RS485, Ethernet, optional:Wi-Fi, Cellular, LAN
Warranty	5 years (extendable to 20 years)

Ginlong Technologies Co., Ltd.

No. 57 Jintong Road, Binhai Industrial Park, Xiangshan, Ningbo,  
Zhejiang, 315712, P.R.China.

Tel: +86 (0)574 6578 1806

Fax: +86 (0)574 6578 1606

Email: [info@ginlong.com](mailto:info@ginlong.com)

Web: [www.ginlong.com](http://www.ginlong.com)

Please adhere to the actual products in case of any discrepancies in this user manual.

If you encounter any problem on the inverter, please find out the inverter S/N and contact us, we will try to respond to your question ASAP.