



Solis Three Phase Inverter

Solis-(75-110)K-5G-PRO **Installation and Operation Manual**

Ver 1.1

Ginlong Technologies Co., Ltd.

No. 188 Jinkai Road, Binhai Industrial Park, Xiangshan, Ningbo,
Zhejiang, 315712, P.R.China.

Tel: +86 (0)574 6578 1806

Fax: +86 (0)574 6578 1606

Email: info@ginlong.com

Web: www.ginlong.com

Please adhere to the actual products in case of any discrepancies in this user manual.

If you encounter any problem on the inverter, please find out the inverter S/N
and contact us, we will try to respond to your question ASAP.



Ginlong Technologies Co., Ltd.

Contents

1. Introduction	4
1.1 Product Description	4
1.2 Unpacking and storage	5
1.2.1 Storage	6
2. Safety instructions	7
2.1 Safety symbols	7
2.2 General safety instructions	7
2.3 Notice for use	8
2.4 Notice for Disposal	8
3. Installation	9
3.1 Environmental considerations	9
3.1.1 Select a location for the inverter	9
3.1.2 Installation environment requirements	11
3.2 Product handling	11
3.3 Mounting the Inverter	12
3.3.1 Wall mounting	13
3.3.2 Rack mounting	15
3.4 Electrical Connections	17
3.4.1 Grounding	18
3.4.2 Connect PV side of inverter	20
3.4.3 Connect grid side of inverter	31
4. Communication & Monitoring	35
4.1 RS485 Communication	35
4.2 PLC Communication	37
4.3 Logic interface connection	38
5. Commissioning	39
5.1 Selecting the appropriate grid standard	39
5.1.1 Verifying grid standard for country of installation	39
5.2 Changing the grid standard	39
5.2.1 Procedure to set the grid standard	39
5.3 Setting a custom grid standard	40
5.4 Preliminary checks	41
5.4.1 DC Connections	41
5.4.2 AC Connections	41
5.4.3 DC configuration	41
5.4.4 AC configuration	42
6. Start and Shutdown	43
6.1 Start-up procedure	43
6.2 Shutdown procedure	43
7. Normal operation	44
7.1 Main Menu	44
7.2 Information	44

Contents

7.2.1 Lock screen	46
7.3 Settings	46
7.3.1 Set Time	46
7.3.2 Set Address	46
7.4 Advanced Info - Technicians Only	47
7.4.1 Alarm Message	47
7.4.2 Running Message	47
7.4.3 Version	48
7.4.4 Daily Energy	48
7.4.5 Monthly Energy	48
7.4.6 Yearly Energy	49
7.4.7 Daily Records	49
7.4.8 Communication Data	49
7.4.9 Warning Message	49
7.5 Advanced Settings - Technicians Only	50
7.5.1 Selecting Standard	50
7.5.2 Grid ON/OFF	51
7.5.3 Clear Energy	52
7.5.4 Reset Password	52
7.5.5 Power control	52
7.5.6 Calibrate Energy	52
7.5.7 Special Settings	53
7.5.8 STD Mode settings	53
7.5.9 Restore Settings	54
7.5.10 HMI Update	54
7.5.11 External EPM Set	54
7.5.12 Restart HMI	55
7.5.13 Debug Parameter	55
7.5.14 Fan Test	55
7.5.15 DSP Update	56
7.5.16 Compensation Set	56
7.5.17 I/V Curve	56
7.6 AFCI function	58
7.6.1 Enable the AFCI function	58
7.6.2 Arc Fault	58
8. Maintenance	59
8.1 Anti-PID Function	59
8.2 Fan Maintenance	60
8.3 Smart O&M	60
9. Troubleshooting	61
10. Specifications	64

1. Introduction

1.1 Product Description

Solis Three phase Inverters convert DC power from the photovoltaic(PV) array into alternating current(AC) power that can satisfy local loads as well as feed the power distribution grid.

This manual covers the three phase inverter model listed below:

Solis-80K-5G-PRO, Solis-100K-5G-PRO, Solis-110K-5G-PRO, Solis-50K-LV-5G-PRO, Solis-60K-LV-5G-PRO, Solis-75K-LV-5G-PRO

The following one model is specially supplied for Brazil market:

Solis-75K-5G-PRO

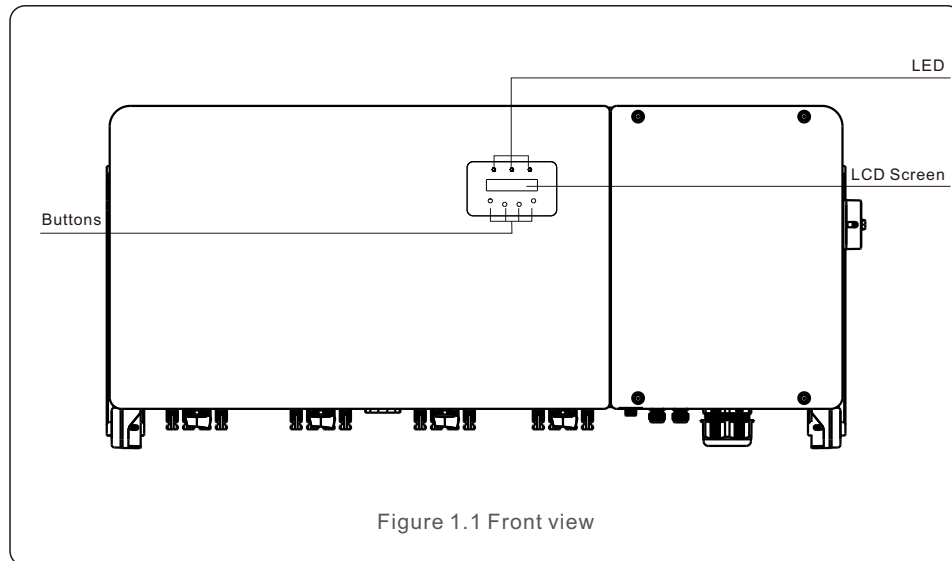

Figure 1.1 Front view

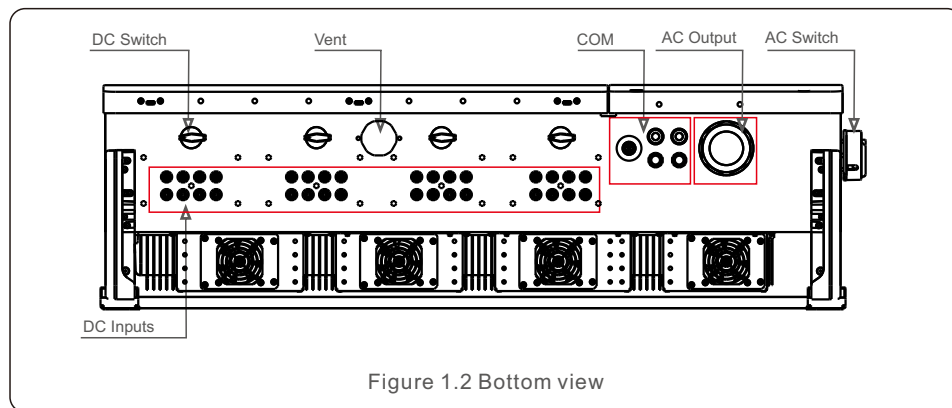

Figure 1.2 Bottom view

1. Introduction

1.2 Unpacking and storage

The inverter ships with all accessories in one carton.

When unpacking, please verify all the parts listed below are included:

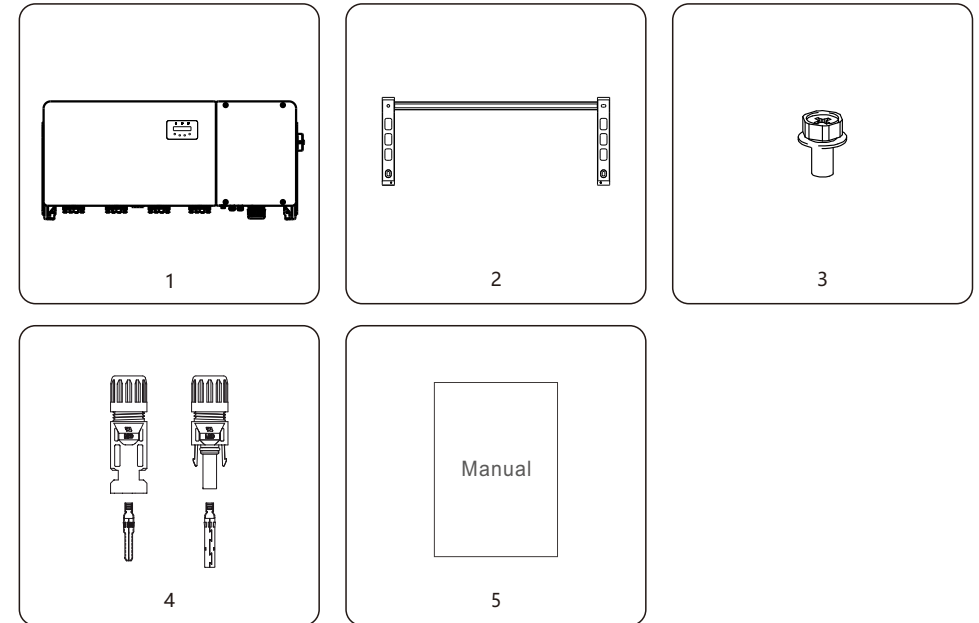

Part #	Description	Number	Remarks
1	Inverter	1	
2	Mounting Bracket	1	
3	Fastening screw	2	Hexagon bolt M6*12
4	DC connector	8 for 50K-LV 12 for (60-75)K-LV 12 for (75-80)K 16 for (100-110)K	
5	User manual	1	

Inverter packing list

1. Introduction

1.2.1 Storage

If the inverter is not installed immediately, storage instructions and environmental conditions are below:

- Use the original box to repackage the inverter, seal with adhesive tape with the desiccant inside the box.
- Store the inverter in a clean and dry place, free of dust and dirt. The storage temperature must be between -40 - 70°C and humidity should be between 0 to 95%, non-condensing.
- Do not stack more than four (4) inverters high on a single pallet.
- Keep the box(es) away from corrosive materials to avoid damage to the inverter enclosure.
- Inspect the packaging regularly. If packing is damaged (wet, pest damages, etc.), repackage the inverter immediately.
- Store inverters on a flat, hard surface -- not inclined or upside down.
- After 100 days of storage, the inverter and carton must be inspected for physical damage before installing. If stored for more than 1 year, the inverter needs to be fully examined and tested by qualified service or electrical personnel before using.
- Restarting after a long period of non-use requires the equipment be inspected and, in some cases, the removal of oxidation and dust that has settled inside the equipment will be required.



Figure 1.3

2. Safety Instructions

Improper use may result in electric shock hazards or burns. This product manual contains important instructions that are required to be followed during installation and maintenance. Please read these instructions carefully before use and keep them in an easily locatable place for future reference.

2.1 Safety Symbols

Safety symbols used in this manual, which highlight potential safety risks and important safety information, are listed below:



WARNING

Symbol indicates important safety instructions, which if not correctly followed, could result in serious injury or death.



NOTE

Symbol indicates important safety instructions, which if not correctly followed, could result in damage to or the destruction of the inverter.



CAUTION, RISK OF ELECTRIC SHOCK

Symbol indicates important safety instructions, which if not correctly followed, could result in electric shock



CAUTION, HOT SURFACE

Symbol indicates safety instructions, which if not correctly followed, could result in burns.

2.2 General Safety Instructions



WARNING

Do not connect PV array positive (+) or negative (-) to ground – doing so could cause serious damage to the inverter.



WARNING

Electrical installations must be done in accordance with local and national electrical safety standards.



WARNING

To reduce the risk of fire, branch circuit over-current protective devices (OCPD) are required for circuits connected to the Inverter.



CAUTION

The PV array (solar panels) supplies a DC voltage when exposed to light.

2. Safety Instructions



CAUTION

Risk of electric shock from energy stored in the inverter's capacitors. Do not remove cover until five (5) minutes after disconnecting all sources of supply have passed, and this can only be done by a service technician. The warranty may be voided if any unauthorized removal of cover occurs.



CAUTION

The inverter's surface temperature can reach up to 75°C. To avoid risk of burns, do not touch the surface when the inverter is operating. Inverter must be installed out of the reach of children.



WARNING

The inverter can only accept a PV array as a DC input. Using any other type of DC source could damage the inverter.

2.3 Notice for Use

The inverter has been constructed according to applicable safety and technical guidelines. Use the inverter in installations that meet the following requirements ONLY:

- 1). The inverter must be permanently installed.
- 2). The electrical installation must meet all the applicable regulations and standards.
- 3). The inverter must be installed according to the instructions stated in this manual.
- 4). The system design must meet inverter specifications.
- 5). The inverter can only be used for industrial.

To start-up the inverter, the Grid Supply Main Switch (AC) must be turned on, BEFORE the DC Switch is turned on. To stop the inverter, the Grid Supply Main Switch (AC) must be turned off before the DC Switch is turned off.

2.4 Notice for Disposal

This product shall not be disposed of with household waste. They should be segregated and brought to an appropriate collection point to enable recycling and avoid potential impacts on the environment and human health. Local rules in waste management shall be respected.

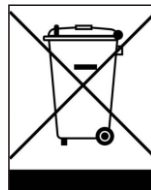

3. Installation

3.1 Environmental Considerations

3.1.1 Select a location for the inverter

When selecting a location for the inverter, consider the following:



WARNING: Risk of fire

- Despite careful construction, electrical devices can cause fires.
- Do not install the inverter in areas containing highly flammable materials or gases.
 - Do not install the inverter in potentially explosive atmospheres.
 - The mounting structure where the inverter is installed must be fireproof.

- The temperature of the inverter heat-sink can reach 75°C.
- The inverter is designed to work in an ambient temperature range between -30°C to 60°C.
- If multiple inverters are installed on site, a minimum clearance of 500mm should be kept between each inverter and all other mounted equipment. The bottom of the inverter should be at least 500mm above of the ground or floor (see Figure 3.1).
- The LED status indicator lights and the LCD located on the inverter's front panel should not be blocked.
- Adequate ventilation must be present if the inverter is to be installed in a confined space.

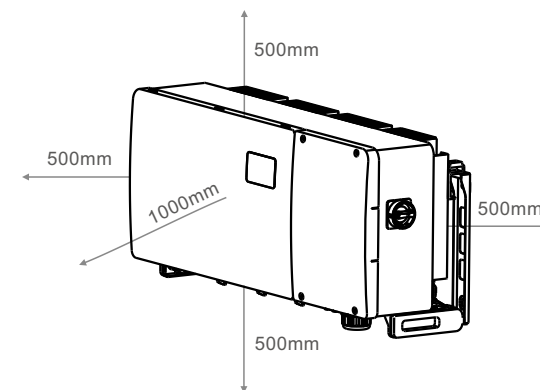

Figure 3.1 Distances required between inverters



NOTE

Nothing should be stored on or placed against the inverter.

3. Installation

3.1.1.1 Examples of correct and incorrect installations

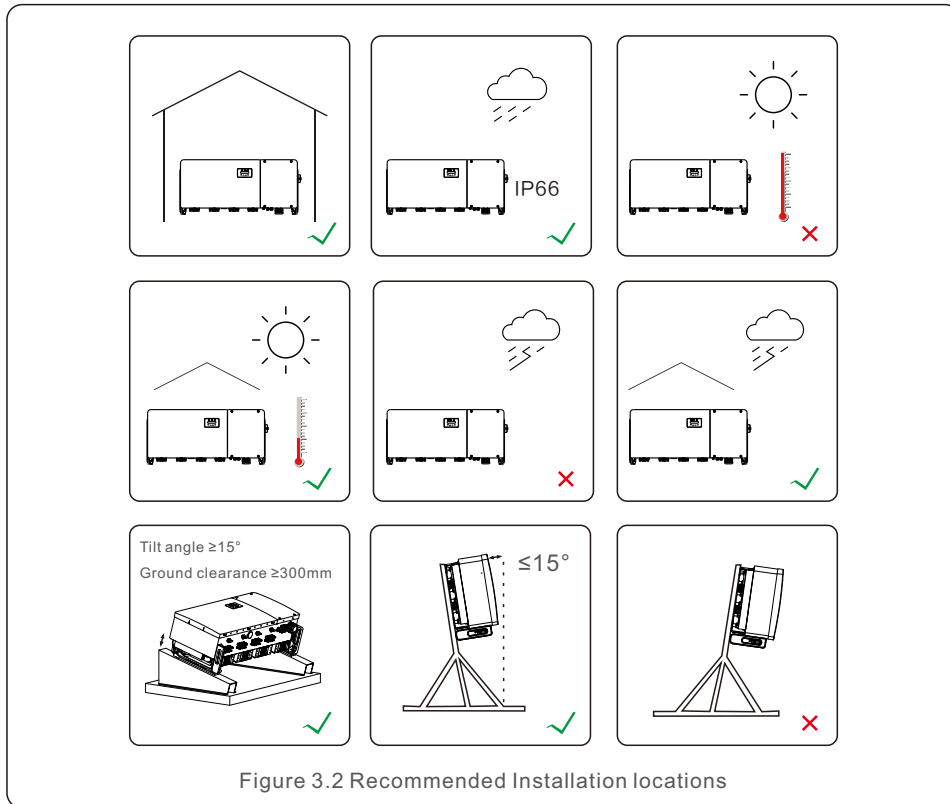

3.1.1.1 Wall and Framework Installation

- The installation of the inverter needs to consider the local weather conditions, and take measures such as rain and snow protection if necessary.
- The installation angle between inverter and wall should be less than 15°.
- Please ensure the distance between the waterproof joint and the installed roof is greater than the local maximum snow thickness. The distance should be larger than the 300mm.
- Bind and fix the cables 300~350mm away from the DC and AC terminals, communication waterproof connectors to prevent the cables from sagging and causing the waterproof connectors to loosen.

3. Installation

3.1.2 Installation environment requirements

• Avoid Direct Sunlight

Installation of the inverter in a location exposed to direct sunlight should be avoided. Direct exposure to sunlight could cause: Inverter temperature rises. Output power limitation (Leads to a reduction of system generation).

• Please ensure the ventilation and well heat dissipation

Do not install the inverter in a small, closed room where air cannot freely circulate. To prevent overheating, please ensure that the air flow around the inverter is not blocked.

• Do not install the inverter near flammable substances

Do not install the inverter near flammable substances. Please ensure the distance between inverter and those flammable objects is larger than 3 meters.

• Avoid installation in living areas

Do not install the inverter in the living area where the prolonged presences of people or animals are expected. There may be produced some noises when the inverter is operating, so a living area installation is not recommended.

Regarding other environment conditions, (for example: Ingress Protection, Temperature, Humidity, and Altitude, etc.), please refer to 10 Specification Part.

3.2 Product handling

Please review the instruction below for handling the inverter:

1. The red circles below denote cutouts on the product package. Push in the cutouts to form handles for moving the inverter (see Figure 3.3).

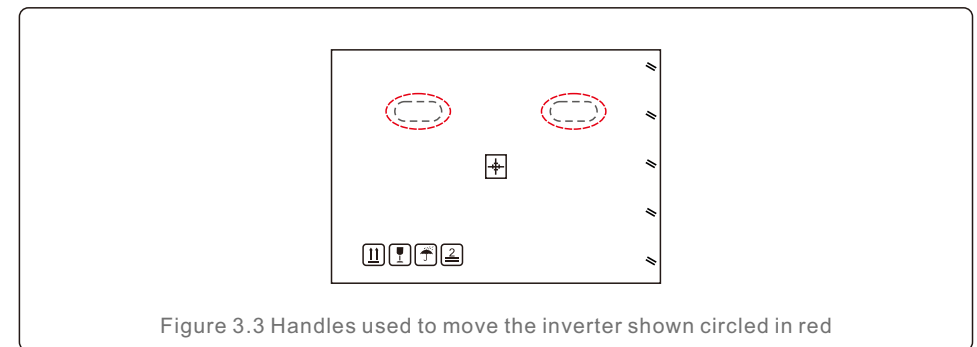

2. Two people are required to remove the inverter from the shipping box. Use the handles integrated into the heat sink to remove the inverter from the carton (see Figure 3.4).

3. Installation

3. Installation

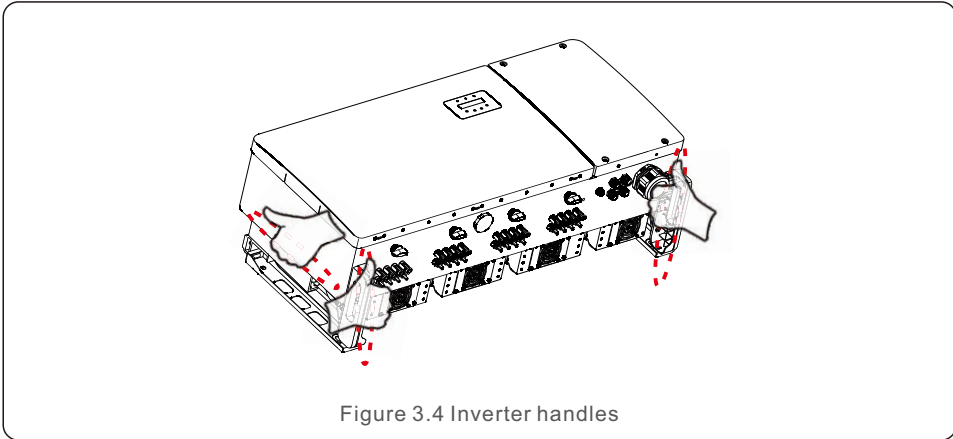

WARNING



Due to the weight of the inverter, contusions or bone fractures could occur when incorrectly lifting and mounting the inverter. When mounting the inverter, take the weight of the inverter into consideration. Use a suitable lifting technique when mounting.

3.3 Mounting the Inverter

The inverter can be mounted to the wall or metal array racking. The mounting holes should be consistent with the size of the bracket or the dimensions shown in Figure 3.5.

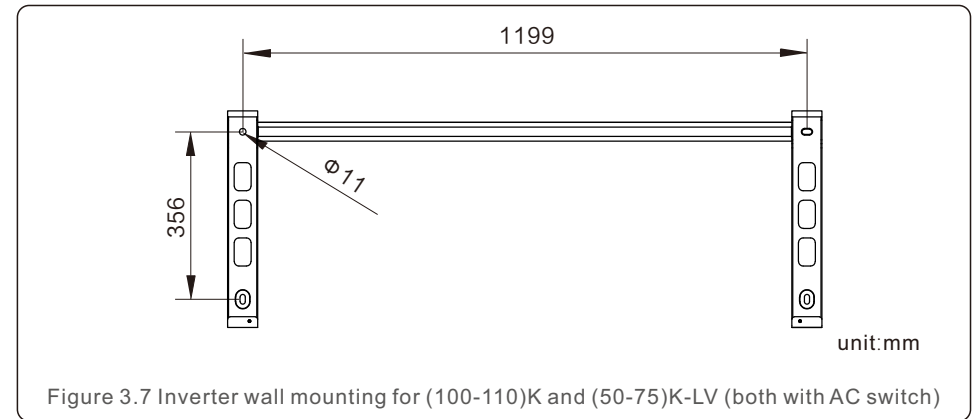
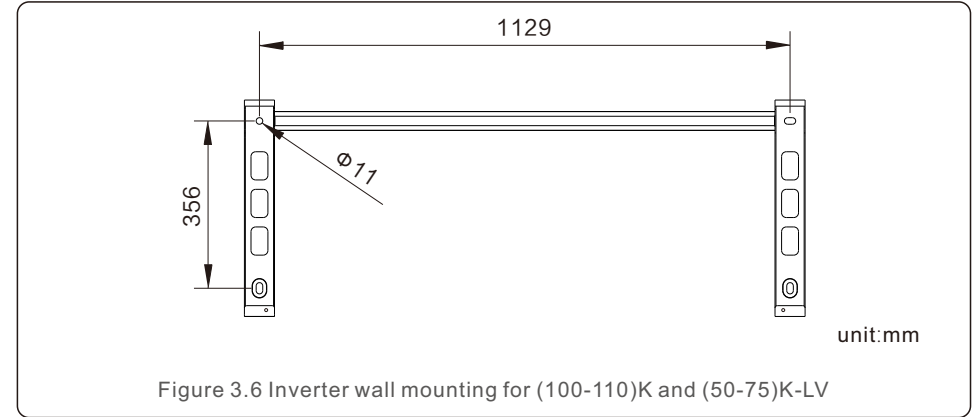
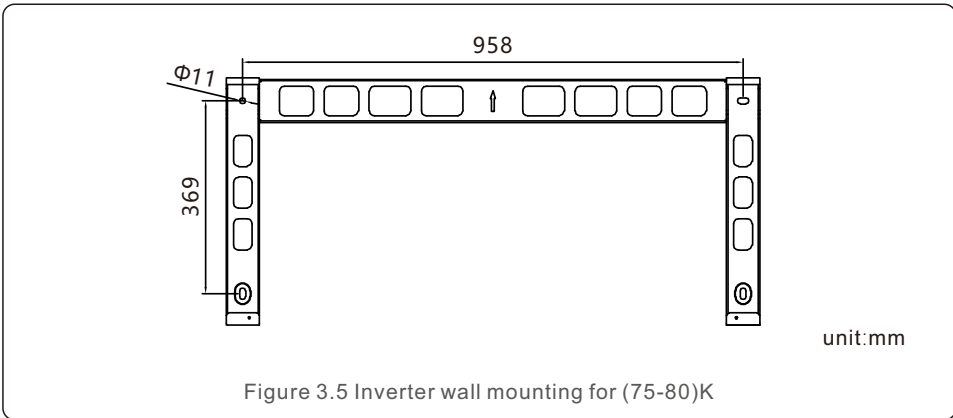

3. Installation

3.3.1 Wall mounting

Refer to figure 3.8 and figure 3.9 Inverter shall be mounted vertically.
The steps to mount the inverter are listed below.

1. Refer to Figure 3.8, drill holes for mounting screws based on the hole diameter of bracket using a precision drill keeping the drill perpendicular to the wall. Max depth is 90mm.
2. Make sure the bracket is horizontal. And the mounting holes (in Figure 3.8) are marked correctly. Drill the holes into wall at your marks.
3. Use the suitable mounting screws to attach the bracket on the wall.

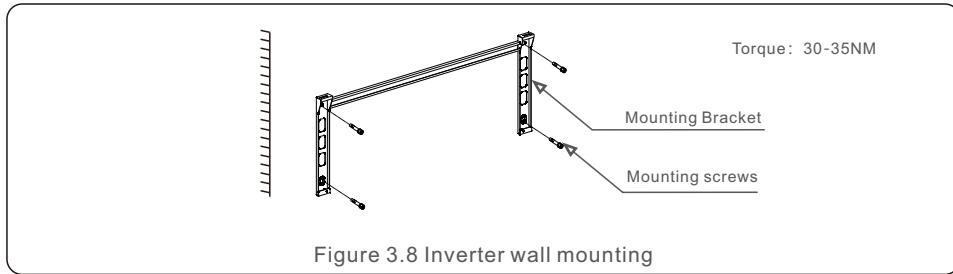

4. Lift the inverter and hang it on the bracket, and then slide down to make sure they match perfectly.

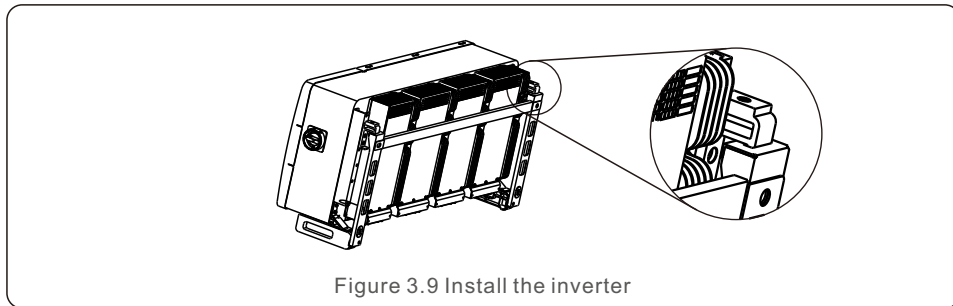

5. Use screws in the packaging to fix the inverter to the mount bracket.

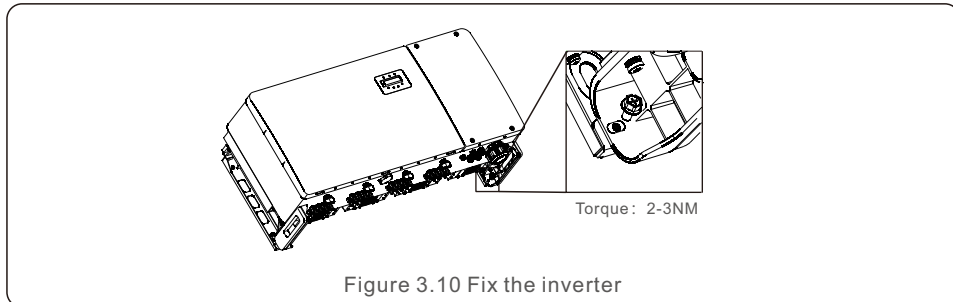

3. Installation

3.3.2 Rack mounting

The steps to mounted to the rack are listed below:

1. Select a location for the inverter
 - With an IP66 protection rating, the inverter can be installed both outdoors and indoors.
 - When the inverter is running, the temperature of the chassis and heat sink will be higher. Do not install the inverter in a location that you accidentally touch.
 - Do not install the inverter in a place where it is stored in a flammable or explosive material.
2. Installation angle
 - Please install the inverter vertically. If the inverter cannot be mounted vertically, it may be tilted backward to 15 degrees from vertical.

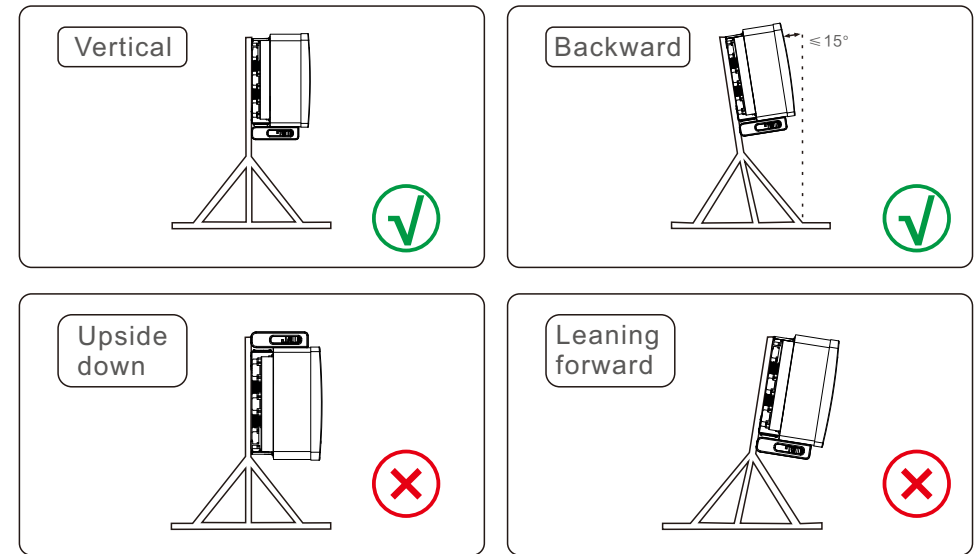

3. Installation

3. Install mounting plate

- 1) Remove the bracket and fasteners from the packaging. Mark the position for hole, drilling according to the hole positions of the bracket.
- 2) Drill the marked holes. It is recommended to apply anti-corrosive paint at the hole for corrosion protection.

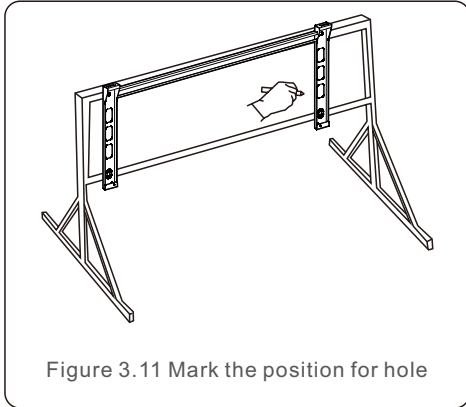

Figure 3.11 Mark the position for hole

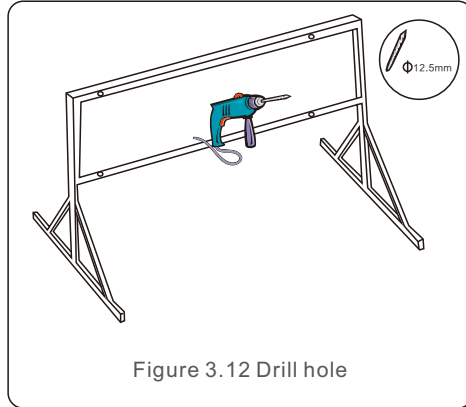

Figure 3.12 Drill hole

- 3) Align the mounting plate with the holes, Insert the combination bolt (M10X40) through the mounting plate into the hole. Secure the bracket to the metal frame firmly with the supplied fastener. Torque the nut to 36FT-LB (35NM).
- 4) Lift the inverter above the bracket and then slide down to make sure they match perfectly.

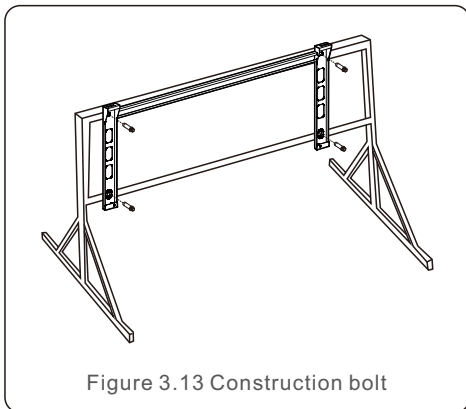

Figure 3.13 Construction bolt

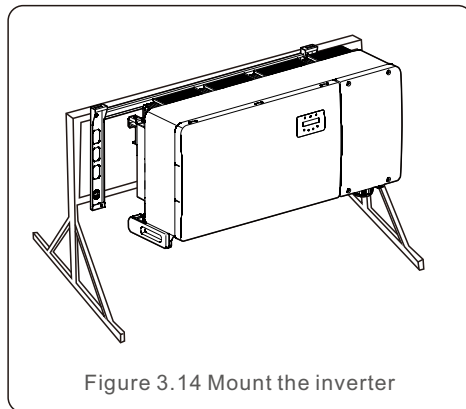

Figure 3.14 Mount the inverter

3. Installation

3.4 Electrical Connections

Inverter design uses PV style quick-connect terminal. The top cover needn't be opened during DC electrical connection. The labels located the bottom of the inverter are described below in table 3.1. All electrical connections are suitable for local or national standard.

Parts	Connection	Cable size	Torque
DC terminal	PV strings	4-6mm ²	NA
Ground terminal	AC ground	25-50mm ²	10-12N.m
Grid terminal	Grid	50-240mm ²	10-20N.m
RS-485 terminal	Communication cable	0.3-4mm ²	0.6N.m
RJ45 terminal	Communication cable	Network Cable	NA
COM terminal	Wi-Fi/Cellular stick	NA	NA
DC surge protection device	NA	NA	NA

Table 3.1 Electrical connection symbols

The electrical connection of the inverter must follow the steps listed below:

1. Switch the Grid Supply Main Switch (AC) OFF.
2. Switch the DC Isolator OFF.
3. Connect the inverter to the grid.
4. Assemble PV connector and connect to the Inverter.

3. Installation

3.4.1 Grounding

To effectively protect the inverter, two grounding methods must be performed.
Connect the AC grounding cable (Please refer to section 3.4.3)
Connect the external grounding terminal.

To connect the grounding terminal on the heat sink, please follow the steps below:

- 1) Prepare the grounding cable: recommend to use the outdoor copper-core cable. The grounding wire should be at least half size of the hot wires.
- 2) Prepare OT terminals: M10.



IMPORTANT

For multiple inverters in parallel, all inverters should be connected to the same ground point to eliminate the possibility of a voltage potential existing between inverter grounds.

- 3) Strip the ground cable insulation to a suitable length(see Figure 3.15).

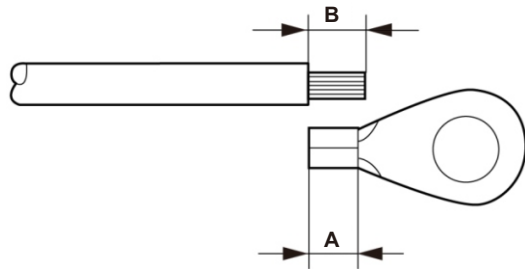

Figure 3.15 Suitable length



IMPORTANT

B (insulation stripping length) is 2mm~3mm longer than A (OT cable terminal crimping area).

- 4) Insert the stripped wire into the OT terminal crimping area and use the hydraulic clamp to crimp the terminal to the wire (see Figure 3.16).

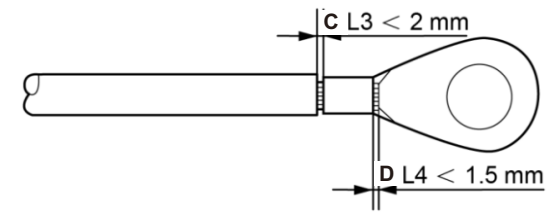

Figure 3.16 Strip wire



IMPORTANT

After crimping the terminal to the wire, inspect the connection to ensure the terminal is solidly crimped to the wire.

- 5) Remove the screw from the heat sink ground point.
- 6) Connect the grounding cable to the grounding point on the heat sink, and tighten the grounding screw, Torque is 10-12Nm(see figure 3.17).

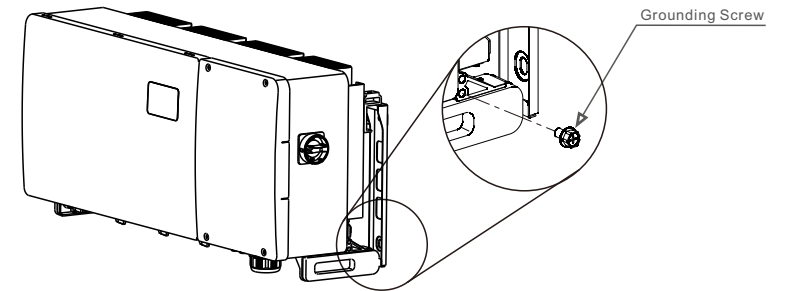

Figure 3.17 Fixed cable



IMPORTANT

For improving anti-corrosion performance, after ground cable installed, apply silicone or paint.

3. Installation

3. Installation

3.4.2 Connect PV side of inverter



WARNING

Before connecting the inverter, make sure the PV array open circuit voltage is within the limit of the inverter. Otherwise, the inverter could be damaged.



WARNING

DO NOT connect the PV array positive or PV array negative cable to ground. This can cause serious damage to the inverter!



WARNING

MAKE SURE the polarity of the PV array output conductors matches the DC- and DC+ terminal labels before connecting these conductors to the terminals of the inverter.



WARNING

Please use the original DC MC4 terminals, otherwise the unqualified DC connectors may cause damages to the inverter.

Please see table 3.1 for acceptable wire size for DC connections. Wire must be copper only. The steps to assemble the DC connectors are listed as follows:

1. Strip off the DC wire for about 7mm, Disassemble the connector cap nut.
2. Insert the wire into the connector cap nut and contact pin.

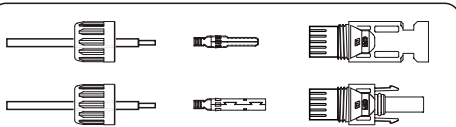

Figure 3.18 Disassemble the Connector Cap nut

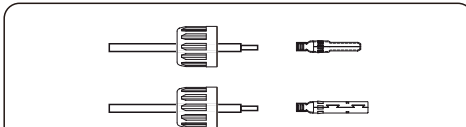

Figure 3.19 Insert the Wire into the Connector Cap nut and contact pin

3. Crimp the contact pin to the wire using a proper wire crimper.
4. Insert metal connector into top of connector, and tighten nut with torque 3-4 Nm.

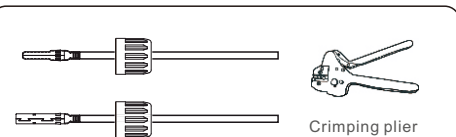

Figure 3.20 Crimp the contact pin to the wire

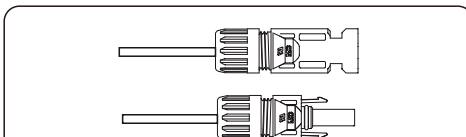

Figure 3.21 Connector with Cap nut Screwed on

5. Measure PV voltage of DC input with multimeter, verify DC input cable polarity (see figure 3.22), and ensure each string voltage is in range of inverter operation. Connect DC connector with inverter until hearing a slight clicking sound indicating successful connection. (see figure 3.23)

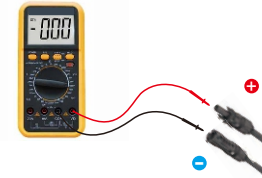

Figure 3.22 Multimeter measurement

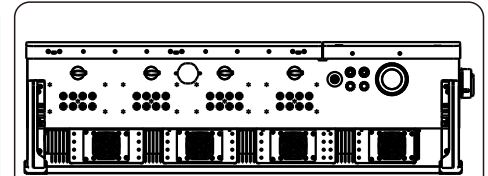

Figure 3.23 Connect the DC Connectors to the Inverter

Cable type	Traverse area (mm ²)		Outside diameter of cable (mm)
	Range	Recommended value	
Industry generic PV cable (model:PV1-F)	4.0~6.0 (12~10AWG)	4.0 (12AWG)	5.5~9.0

Table 3.2



CAUTION

If DC inputs are accidentally reversely connected or inverter is faulty or not working properly, it is NOT allowed to turn off the DC switch. Otherwise it may cause DC arc and damage the inverter or even lead to a fire disaster.

The correct actions are:

*Use a clip-on ammeter to measure the DC string current.

*If it is above 0.5A, please wait for the solar irradiance reduces until the current decreases to below 0.5A.

*Only after the current is below 0.5A, you are allowed to turn off the DC switches and disconnect the PV strings.

* In order to completely eliminate the possibility of failure, please disconnect the PV strings after turning off the DC switch to avoid secondary failures due to continuous PV energy on the next day.

Please note that any damages due to wrong operations are not covered in the device warranty.

3. Installation

Requirements for the PV modules per MPPT input:

- All PV modules must be of the same type and power rating.
- Please ensure the PV strings are evenly connected to the inverter and try to utilize all the MPPT trackers.
- All PV modules must be aligned and tilted identically.
- The open-circuit voltage of the PV array must never exceed the maximum input voltage of the inverter, even at the coldest expected temperature. (see section 10 “Specifications” for input current and voltage requirements)
- Each string connected to a single MPPT must consist of the same number of series-connected PV modules.

3.4.2.1 DC connection high voltage danger notice



CAUTION
RISK OF ELECTRIC SHOCK

Do not touch an energized DC conductor. There are high voltages present when PV modules are exposed to light causing a risk of death due to an electric shock from touching a DC conductor!

Only connect the DC cables from the PV module to the inverter as described in this manual.



CAUTION
POTENTIAL DAMAGE TO THE INVERTER DUE TO OVERVOLTAGE

The DC input voltage of the PV modules must not exceed the maximum rating of the inverter. (see section 10 “Specifications”)

Check the polarity and the open-circuit voltage of the PV strings before connecting the DC cables to the inverter.

Confirm proper string length and voltage range before connecting DC cable to the inverter.

3.4.2.2 Wiring requirement

When cables are used for a long time, the insulation layer may deteriorate or be damaged due to high temperature etc. If the cable is exposed to the natural environment, it may cause faults such as short circuit etc. You are advised to route the PV cable through the wave fiber tube and the bridge to effectively protect the PV cable from damage.

Similar cables should be tied together, and different types of cables should be placed at least 30mm clearance separately, and they are prohibited from entanglement or crossing. The cables used in the PV grid -connected power generation system must be firm, good in insulation, and appropriate specifications.

3. Installation

3.4.2.3 String Input Instructions



NOTE
To achieve the best power generation effect, add components according to the recommended solution.

Recommended access scheme for 182mm component of (75-80)K inverter

The (75-80)K inverter has three sets of power modules inside, as shown in the figure below. In order to achieve the best power generation, we strongly recommend that the three power modules are evenly connected to the solar panels. (Note: The "evenly" here means that the difference of the input power between different power modules does not exceed 5%)

Power Module 1



PV 1-4

Power Module 2



PV 5-8

Power Module 3



PV 9-12

If three power modules are indeed required to connect the solar panels unevenly, for a power module which is connected to four strings, it is necessary to ensure that the power of each PV string connected under this power module does not exceed 9.2kW to achieve better power generation performance. In the case that the power difference between each PV string is less than 10%, the 2 common cases are showing below.

Case 1

Power Module 1
(PV 1-4)



$\leq 9.2 \leq 9.2 \leq 9.2 \leq 9.2 \text{ kW}$

Power Module 2
(PV 5-8)



Power Module 3
(PV 9-12)



Case 2

Power Module 1
(PV 1-4)

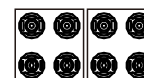

$\leq 9.2 \leq 9.2 \leq 9.2 \leq 9.2 \text{ kW}$

Power Module 2
(PV 5-8)



$\leq 9.2 \leq 9.2 \leq 9.2 \leq 9.2 \text{ kW}$

Power Module 3
(PV 9-12)

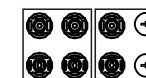

3. Installation

3. Installation

Recommended access scheme for 210mm component of (75-80)K inverter

The (75-80)K inverter has three sets of power modules inside, as shown in the figure below. In order to achieve the best power generation, we strongly recommend that the three power modules are evenly connected to the solar panels. (Note: The "evenly" here means that the difference of the input power between different power modules does not exceed 5%)

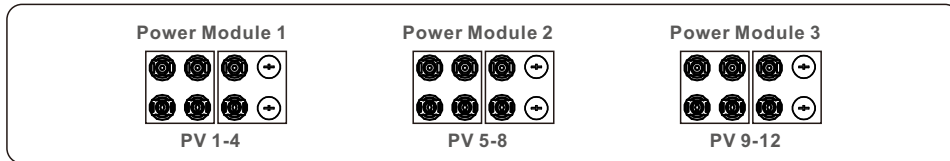

If three power modules are indeed required to connect the solar panels unevenly, for a power module which is connected to three strings, it is necessary to ensure that the power of each PV string connected under this power module does not exceed 12.2kW to achieve better power generation performance. In the case that the power difference between each PV string is less than 10%, the 2 common cases are showing below.

Case 1

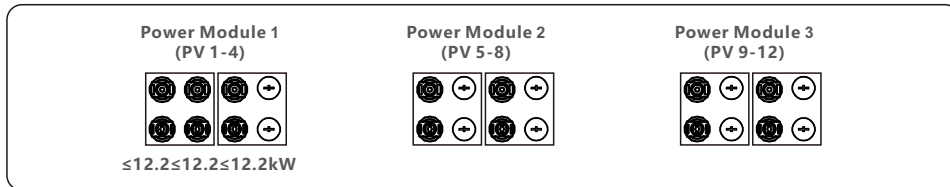

Case 2

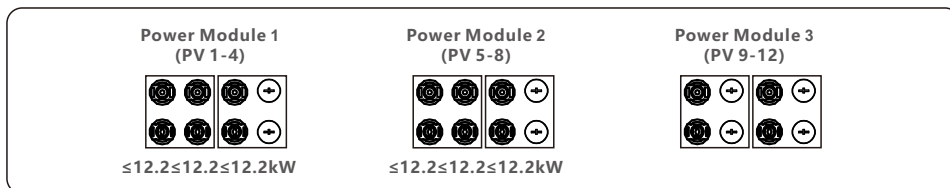

Recommended access scheme for 182mm component of (100-110)K inverter

The (100-110)K inverter has four sets of power modules inside, as shown in the figure below. In order to achieve the best power generation, we strongly recommend that the four power modules are evenly connected to the solar panels. (Note: The "evenly" here means that the difference of the input power between different power modules does not exceed 5%)

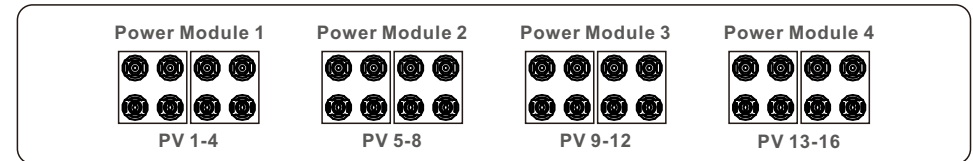

If four power modules are indeed required to connect the solar panels unevenly, for a power module which is connected to four strings, it is necessary to ensure that the power of each PV string connected under this power module does not exceed 9.2kW to achieve better power generation performance. In the case that the power difference between each PV string is less than 10%, the 3 common cases are showing below.

Case 1

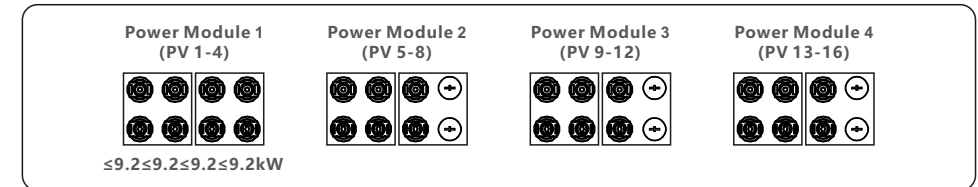

Case 2

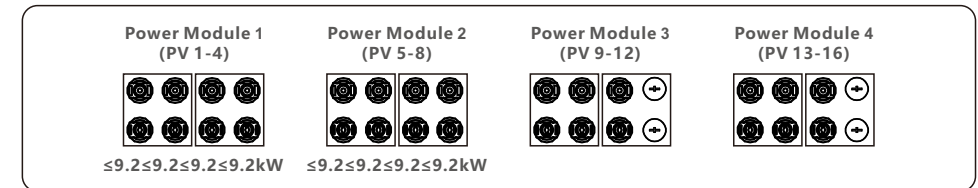

Case 3

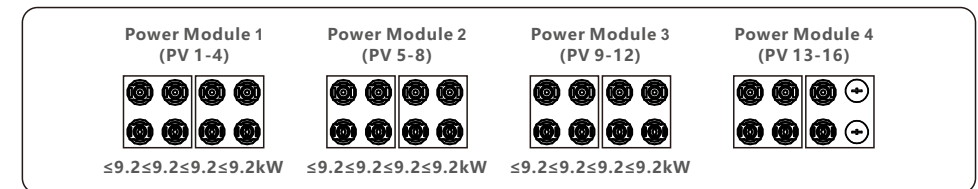

3. Installation

3. Installation

Recommended access scheme for 210mm component of (100-110)K inverter

The (100-110)K inverter has four sets of power modules inside, as shown in the figure below. In order to achieve the best power generation, we strongly recommend that the four power modules are evenly connected to the solar panels. (Note: The "evenly" here means that the difference of the input power between different power modules does not exceed 5%)

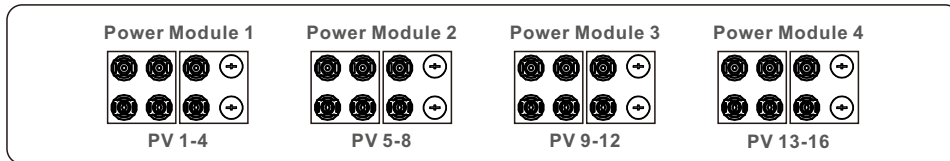

If four power modules are indeed required to connect the solar panels unevenly, for a power module which is connected to three strings, it is necessary to ensure that the power of each PV string connected under this power module does not exceed 12.2kW to achieve better power generation performance. In the case that the power difference between each PV string is less than 10%, the 3 common cases are showing below.

Case 1

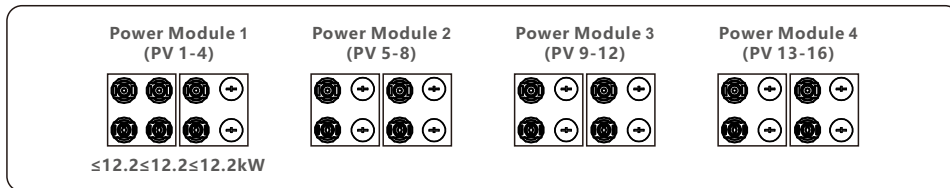

Case 2

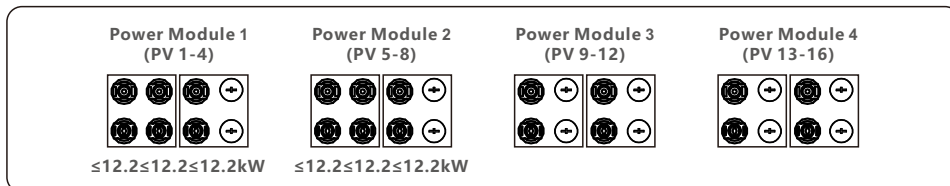

Case 3

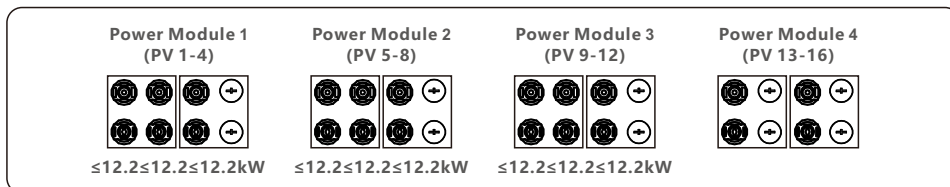

Recommended access scheme for 182mm component of 50K-LV inverter

The 50K-LV inverter has four sets of power modules inside, as shown in the figure below. In order to achieve the best power generation, we strongly recommend that the four power modules are evenly connected to the solar panels. (Note: The "evenly" here means that the difference of the input power between different power modules does not exceed 5%)

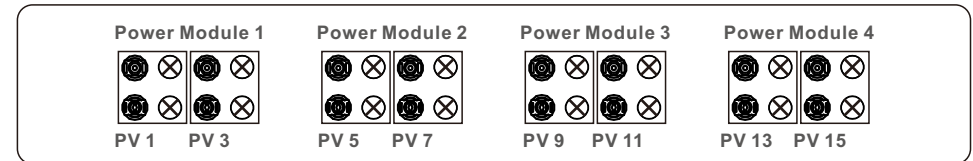

If four power modules are indeed required to connect the solar panels unevenly, for a power module which is connected to no more than two strings, it is necessary to ensure that the power of each PV string connected under this power module does not exceed 10.6kW to achieve better power generation performance. In the case that the power difference between each PV string is less than 10%, the 1 common cases are showing below.

Case 1

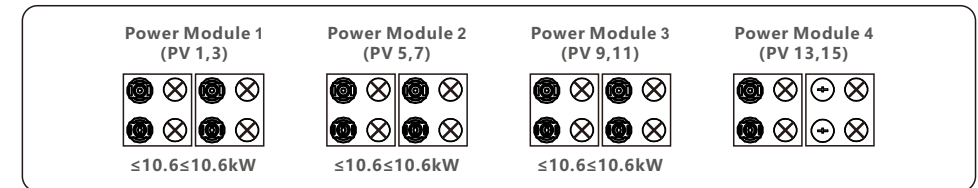

3. Installation

3. Installation

Recommended access scheme for 210mm component of 50K-LV inverter

The 50K-LV inverter has four sets of power modules inside, as shown in the figure below. In order to achieve the best power generation, we strongly recommend that the four power modules are evenly connected to the solar panels. (Note: The "evenly" here means that the difference of the input power between different power modules does not exceed 5%)

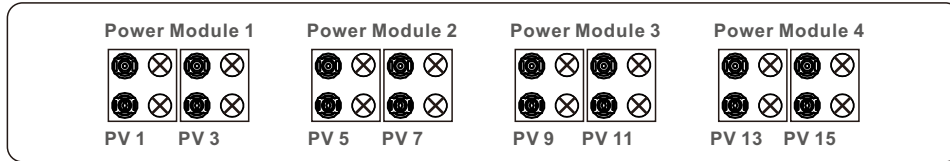

If four power modules are indeed required to connect the solar panels unevenly, for a power module which is connected to no more than two strings, it is necessary to ensure that the power of each PV string connected under this power module does not exceed 10.6kW to achieve better power generation performance. In the case that the power difference between each PV string is less than 10%, the 2 common cases are showing below.

Case 1

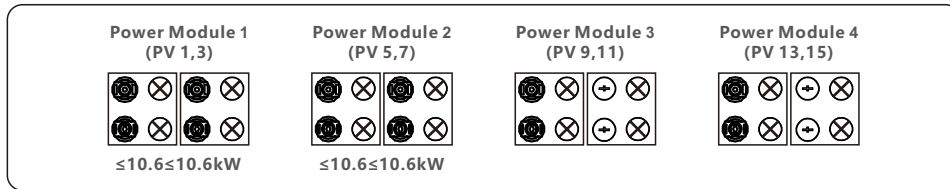

Case 2

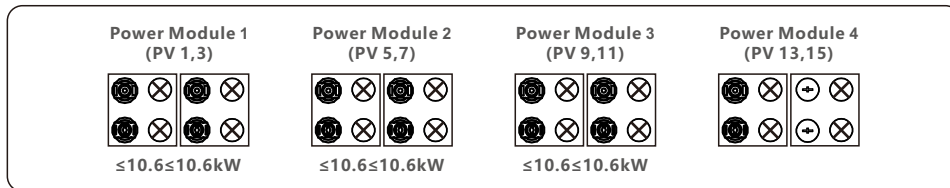

Recommended access scheme for 182mm component of (60-75)K-LV inverter

The (60-75)K-LV inverter has four sets of power modules inside, as shown in the figure below. In order to achieve the best power generation, we strongly recommend that the four power modules are evenly connected to the solar panels. (Note: The "evenly" here means that the difference of the input power between different power modules does not exceed 5%)

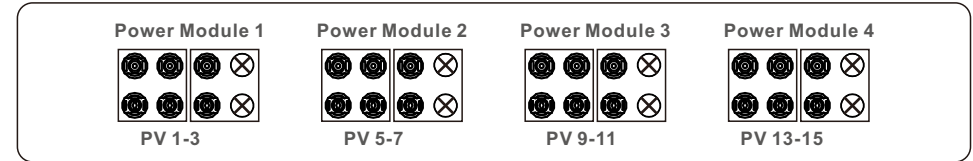

If four power modules are indeed required to connect the solar panels unevenly, for a power module which is connected to no more than three strings, it is necessary to ensure that the power of each PV string connected under this power module does not exceed 7.6kW to achieve better power generation performance. In the case that the power difference between each PV string is less than 10%, the 3 common cases are showing below.

Case 1

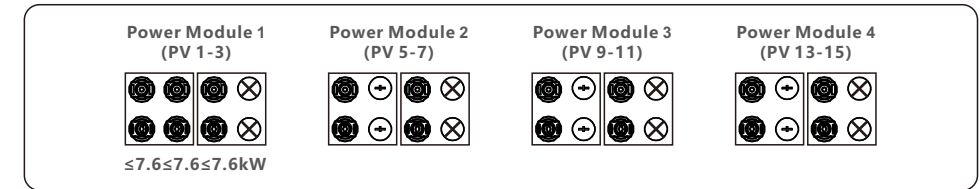

Case 2

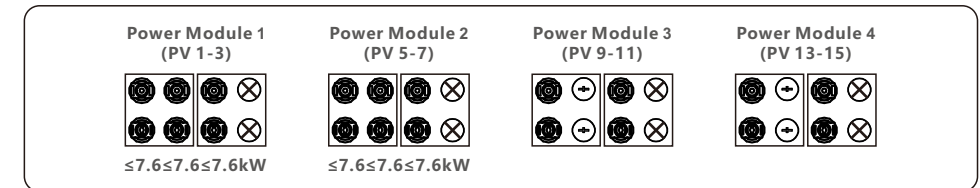

Case 3

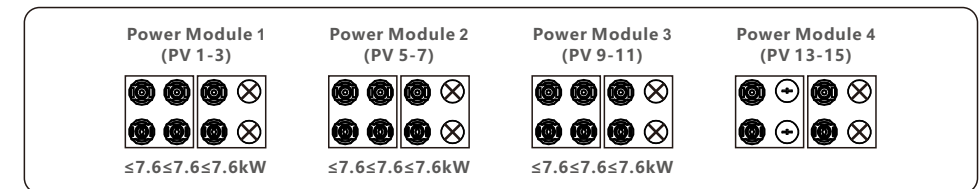

3. Installation

Recommended access scheme for 210mm component of (60-75)K-LV inverter

The (60-75)K-LV inverter has four sets of power modules inside, as shown in the figure below. In order to achieve the best power generation, we strongly recommend that the four power modules are evenly connected to the solar panels. (Note: The "evenly" here means that the difference of the input power between different power modules does not exceed 5%)

Case 1

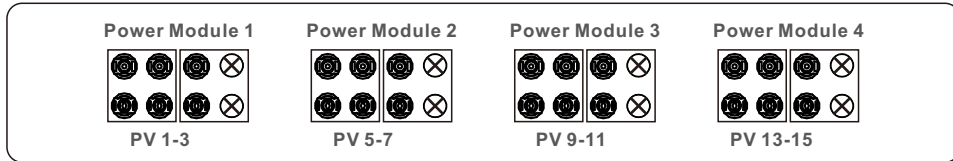

Case 2

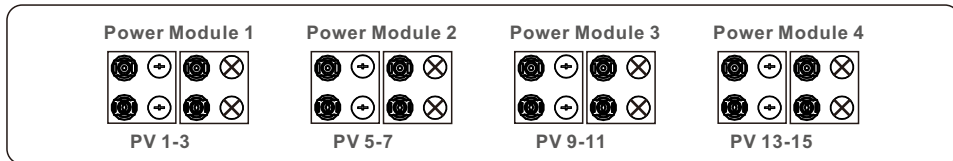

If four power modules are indeed required to connect the solar panels unevenly, for a power module which is connected to no more than three strings, it is necessary to ensure that the power of each PV string connected under this power module does not exceed 7.6kW to achieve better power generation performance. In the case that the power difference between each PV string is less than 10%, the 3 common cases are showing below.

Case 1

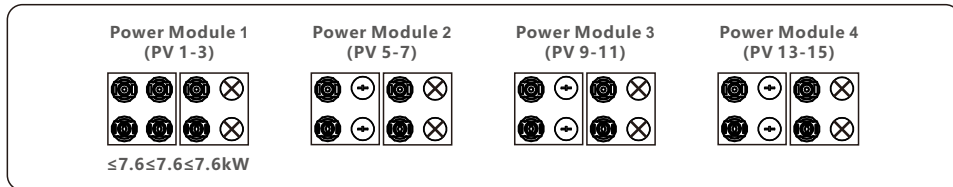

Case 2

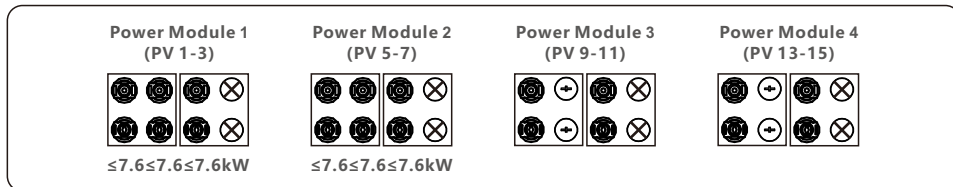

3. Installation

Case 3

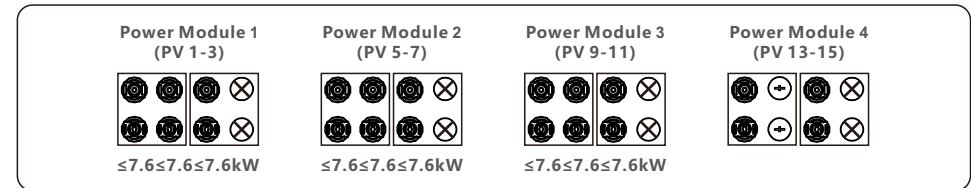

3.4.3 Connect grid side of inverter



WARNING

An over-current protection device must be used between the inverter and the grid.

1. Connect the three (3) AC conductors to the three (3) AC terminals marked "L1", "L2" and "L3". Refer to local code and voltage drop tables to determine the appropriate wire size and type.
2. Connect the grounding conductor to the terminal marked "PE" (protective earth, the ground terminal).

Over-Current Protection Device (OCPD) for the AC side

To protect the inverter's AC connection line, we recommend installing a device for protection against over-current and leakage, with the following characteristics noted in Table 3.3:



NOTE

Use AL-CU transfer (bi-metallic) terminal or anti-oxidant grease with aluminum cables and terminals.

Inverter	Rated voltage(V)	Rated output current (Amps)	Current for protection device (A)
Solis-75K-5G-PRO	220/380,230/400	114	150
Solis-80K-5G-PRO	220/380,230/400	121.6/115.5	150
Solis-100K-5G-PRO	220/380,230/400	152.0/144.3	200
Solis-110K-5G-PRO	220/380,230/400	167.1/158.8	250
Solis-50K-LV-5G-PRO	220	131.2	150
Solis-60K-LV-5G-PRO	220	157.5	200
Solis-75K-LV-5G-PRO	220	196.8	250

Table 3.3 Rating of grid OCPD

3. Installation

3. Installation

3.4.3.1 Connecting the inverter to the utility grid

All electrical installations must be carried out in accordance with the local standards and the National Electrical Code® ANSI/NFPA 70 or the Canadian Electrical Code® CSA C22.1. The AC and DC electric circuits are isolated from the enclosure. If required by section 250 of the National Electrical Code®, ANSI/NFPA 70, the installer is responsible for grounding the system.

The grid voltage must be within the permissible range. The exact operating range of the inverter is specified in section 10 "Specifications".

3.4.3.2 Wiring procedure



CAUTION

RISK OF ELECTRIC SHOCK. Prior to starting the wiring procedure, ensure that the three-pole circuit breaker is switched off and cannot be reconnected.



NOTE

Damage or destruction of the inverter's electronic components due to moisture and dust intrusion will occur if the enclosure opening is enlarged.



CAUTION

Risk of fire if two conductors are connected to one terminal. If a connection of two conductors to a terminal is made, a fire can occur. NEVER CONNECT MORE THAN ONE CONDUCTOR PER TERMINAL.



NOTE

Use M10 crimp terminals to connect to the inverter AC terminals.

Cable specification		Copper-cored cable
Traverse cross sectional area (mm ²)	Range	35~240
	Recommended	70
Cable outer diameter (mm)	Range	38~56
	Recommended	45

Table 3.4

1. Strip the end of AC cable insulating jacket about 300mm then strip the end of each wire.

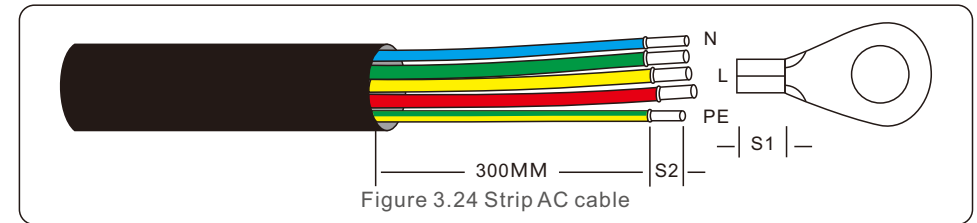

NOTE

S2 (insulation stripping length) is 2mm-3mm longer than S1. (OT cable terminal crimping area)

2. Strip the insulation of the wire past the cable crimping area of the OT terminal, then use a hydraulic crimp tool to crimp the terminal. The crimped portion of the terminal must be insulated with heat shrinkable tube or insulating tape.



NOTE:

If choosing aluminum alloy cable, you must use copper aluminum transfer terminal in order to avoid direct contact between copper bar and Aluminum alloy cable. (Please select a copper aluminum transfer terminal based on your cable specification).

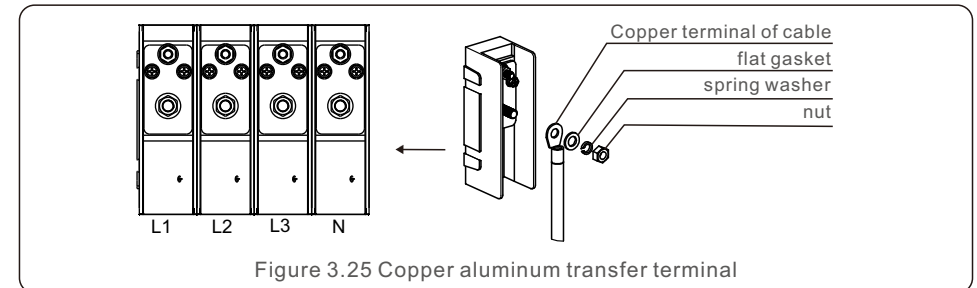

3. Leave the AC breaker disconnected to ensure it does not close unexpectedly.

3. Installation

4. Remove the 4 screws on the inverter junction box and remove the junction box cover.

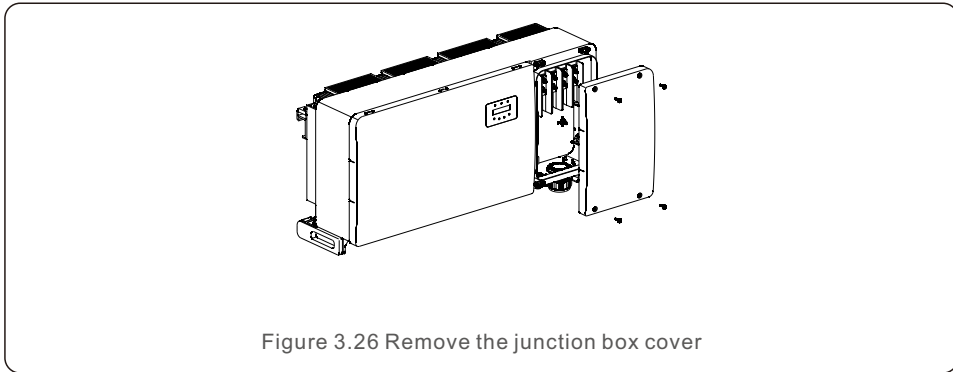

Figure 3.26 Remove the junction box cover

5. Insert the cable through the nut, sheath, and AC terminal cover. Connect the cable to the AC terminal block in turn, using a socket wrench. Tighten the screws on the terminal block. The torque is 10~20Nm.

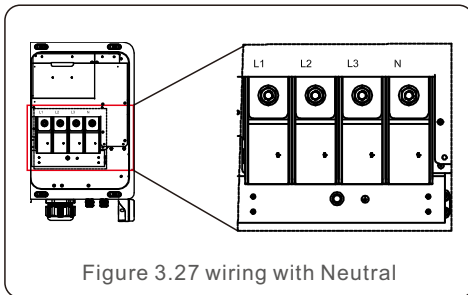

Figure 3.27 wiring with Neutral

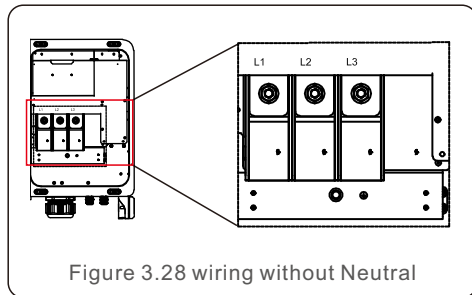

Figure 3.28 wiring without Neutral



NOTE

Solis three phase inverters integrate neutral connection point. However, with or without neutral connected won't affect the normal operation of inverter itself. Please refer to the local grid requirement if need neutral cable connected.

4. Comm. & Monitoring

There are 5 communication terminals on the inverters.
 COM1 is a 4-pin connector reserved for WiFi/Cellular datalogger.
 COM2 - COM3 are used for RS485 communication between inverters.
 Both RJ45 and terminal block are provided for use.
 COM4 or COM5 can be used for DRM connection.
 Detailed connection please refer to 4.2 section.

4.1 RS485 Communication

Monitoring system for multiple inverters

Multiple inverters can be monitored through RS-485 daisy chain configuration.

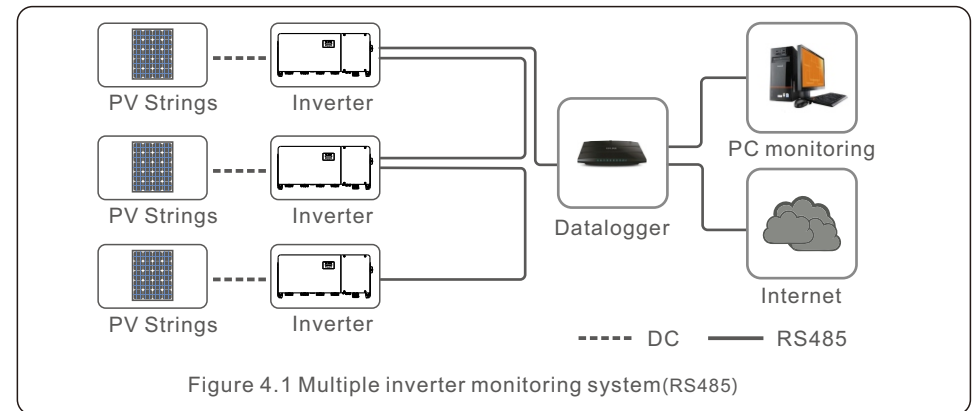

Figure 4.1 Multiple inverter monitoring system(RS485)

RS-485 communication supports two connections methods: RJ45 connectors/ Terminal board

1. RS-485 communication through RJ45 connector

RJ45 port connection (See figure 4.2).

CAT 5E outdoor rated (cable outer diameter<9mm, internal resistance≤1.5 /10m) and shielded RJ45 connectors are recommended.

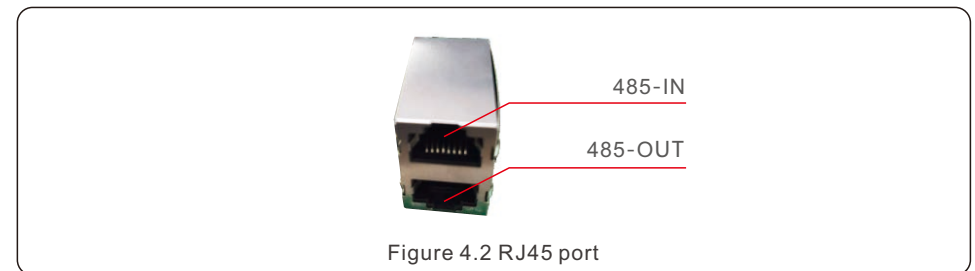
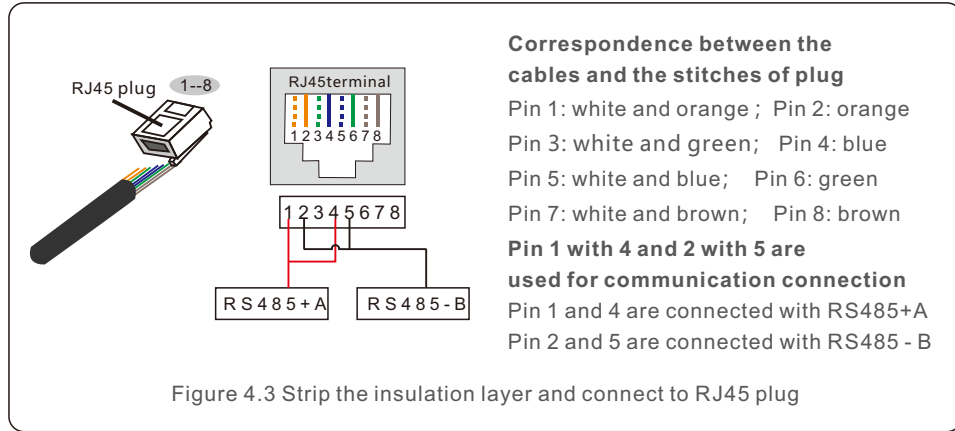

Figure 4.2 RJ45 port

4. Comm. & Monitoring

Use the network wire stripper to strip the insulation layer off the communication cable.
Using the standard wire sequence referenced in TIA/EIA 568B, separate the wires in the cable.
Use a network cable tool to trim the wire. Flatten the wire in the order shown in figure 4.3.



2. RS-485 communication through terminal board.

The cross sectional area of the conductor wire for terminal board connection should be 0.2-1.5mm.

The outer diameter of the cable may be 5mm-10mm.

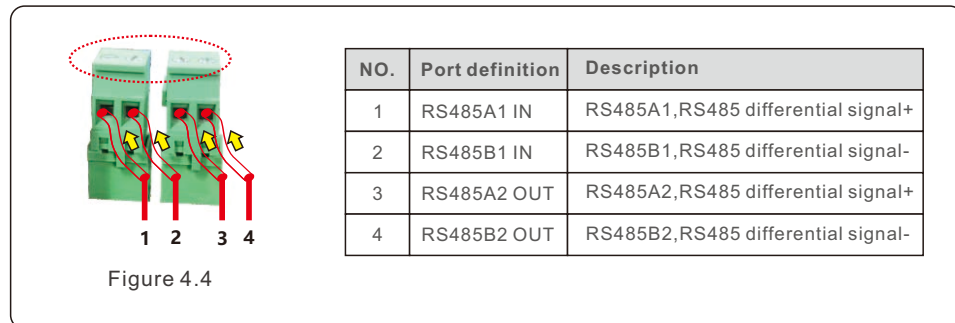

4. Comm. & Monitoring

Connection of Terminal board.

- Strip the insulation and shield to a suitable length. Use diagram below as a guide. (see Figure 4.5).
- Remove the cap nut from the waterproof cable glands labeled at the bottom of the inverter. Remove the plug from the fitting. (see Figure 4.6).

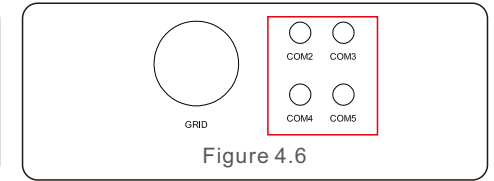
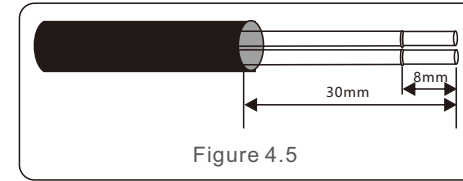

- Insert the cable through the cap nut for each port. COM2(RS485 IN) COM3(RS485 OUT).
- Remove the terminal block on user interface board(See Figure 4.4).
- Insert the cable into the terminal board and tighten the screws in dotted area(See Figure 4.4).
- Replace terminal block onto interface board.

4.2 PLC Communication



NOTE

One of the RS485 and PLC communication methods is available. For the models with additional PLC communication, switching between PLC communication and RS485 communication can be realized by flipping the switch on the communication board as indicated in figure 4.7. Only one communication method is available during operating. Standard model without PLC communication doesn't have this switch.

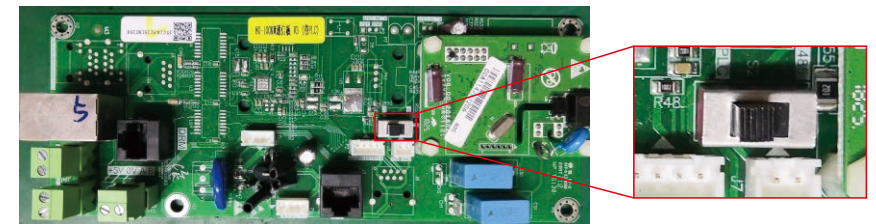

Figure 4.7 Switch between PLC and RS485



WARNING

Must power off the inverter on both AC and DC before switch the communication method.

4. Comm. & Monitoring

PLC is available for multiple inverter monitoring.

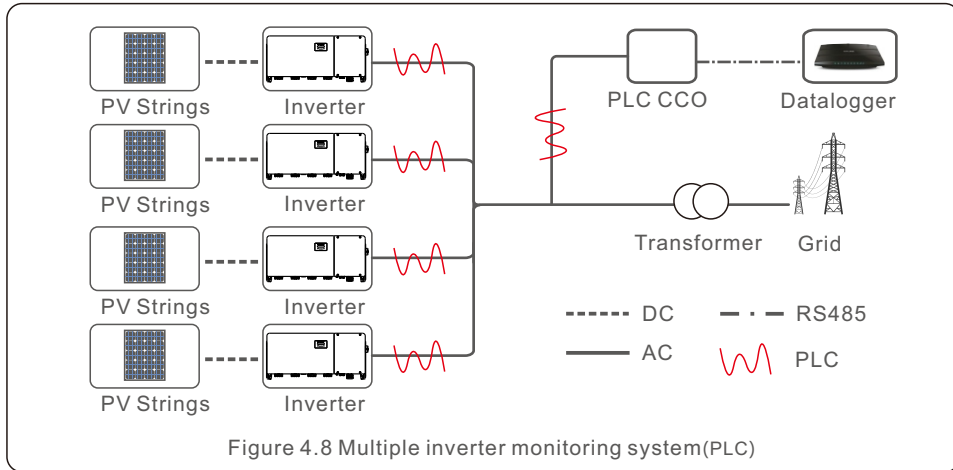

4.3 Logic interface connection

Logic interface is required by some local regulations that can be operated by a simple switch or contactor(Not available in South Africa).

When the switch is closed the inverter can operated normally. When the switch is opened, the inverter will reduce it's output power to zero within 5s.

Pin5 and Pin6 of RJ45 terminal is used for the logic interface connection.

Please follow below steps to assemble RJ45 connector.

- 1.Insert the network cable into the communication connection terminal of RJ45.
- 2.Use the network wire stripper to strip the insulation layer of the communication cable. According to the standard line sequence of figure 4.9 connect the wire to the plug of RJ45, and then use a network cable crimping tool to make it tight.

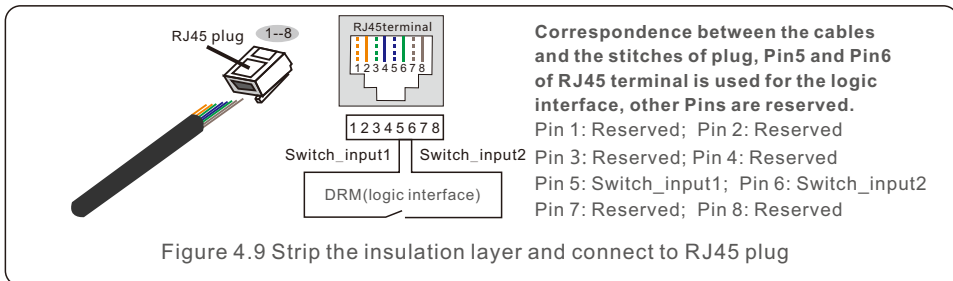

3.Connect RJ45 to DRM (logic interface) .

After wire connection, please refer chapter 7.5.8.1 to enable the logic interface function.

5. Commissioning

5.1 Selecting the appropriate grid standard

5.1.1 Verifying grid standard for country of installation

Solis inverters are used worldwide and feature preset standards for operating on any grid. Although the grid standard is set at the factory, it is essential the grid standard be verified for the country of installation before commissioning.

The menu for changing the grid standard or for creating a custom standard is accessible as described in Section 6.7 and below.



WARNING

Failure to set the correct grid standard could result in improper operation of the inverter, inverter damage or the inverter not operating at all.

5.2 Changing the grid standard

5.2.1 Procedure to set the grid standard



NOTE

This operation is for service technicians only. The inverter is customized according to the local grid standard before shipping. There should be no requirement to set the standard.



NOTE

The "User-Def" function can only be used by the service engineer. Changing the protection level must be approved by the local utility.

- 1). From the main screen on the display, select ENTER. There are 4 sub-menu options, use the UP/DOWN arrows to highlight ADVANCED SETTINGS. Press enter to select.



Figure 5.1

- 2). The screen will show that a password is required. The default password is "0010", press the DOWN key to move cursor, press the UP key to change the highlighted digit.

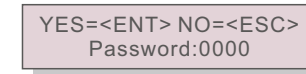

Figure 5.2

5. Commissioning

3). Use the UP/DOWN keys to highlight the SELECT STANDARD option. Press enter to select.

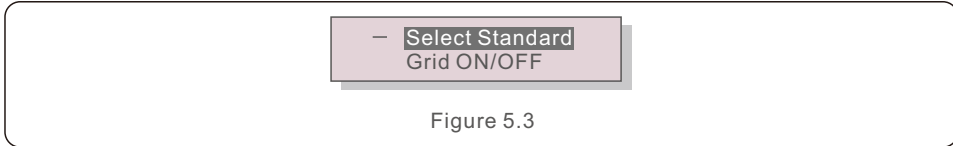

Figure 5.3

4). Select the grid standard for the country of installation.

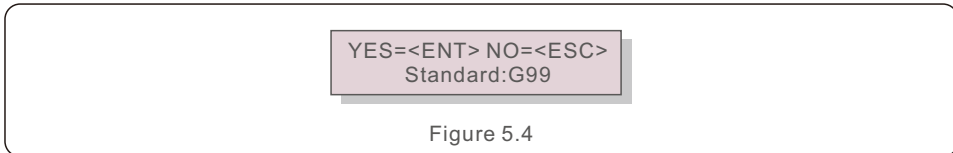

Figure 5.4

Press the UP or DOWN key to select the standard. Press the ENTER key to confirm the setting. Press the ESC key to cancel changes and return to the previous menu.

5.3 Setting a custom grid standard



WARNING

- Failure to set the correct grid standard could result in improper operation of the inverter, inverter damage or the inverter not operating at all.
- Only certified personnel should set the grid standard.
- Only set the grid configuration that is approved by your location and national grid standards.

1). Please refer to section 6.7 “Advanced Settings” for procedures to create a custom grid configuration for User-Def menu option.

5. Commissioning

5.4 Preliminary checks



WARNING

High Voltage.
AC and DC measurements should be made only by qualified personnel.

5.4.1 DC Connections

Verify DC connections.

- 1). Lightly tug on each DC cable to ensure it is fully captured in the terminal.
- 2). Visually check for any stray strands that may not be inserted in the terminal.
- 3). Check to ensure the terminal screws are the correct torque.

5.4.2 AC Connections

Verify AC connections.

- 1). Lightly tug on each AC cable to ensure it is fully captured in the terminal.
- 2). Visually check for any stray strands that may not be inserted in the terminal.
- 3). Check to ensure the terminal screws are the correct torque.

5.4.3 DC configuration

Verify DC configuration by noting the number of panels in a string and the string voltage.

5.4.3.1 VOC and Polarity

Measure VOC, and check string polarity. Ensure both are correct and VOC is in specification.



WARNING

Input voltages higher than the maximum value accepted by the inverter (see “Specifications” in section 10) may damage the inverter. Although Solis inverters feature reverse polarity protection, prolonged connection in reverse polarity may damage these protection circuits and/or the inverter.

5.4.3.2 Leakage to ground

Measure leakage to ground to check for a DC ground fault.

5. Commissioning

5.4.3.2.1 Detection of leakage to ground

Solis inverters are transformer-less and do not have an array connection to ground. Any measurement of a fixed voltage between ground and either the positive or negative string wiring indicates a leakage (ground fault) to ground and must be corrected prior to energizing the inverter or damage to the inverter may result.

5.4.4 AC configuration

Verify AC configuration.

5.4.4.1 Measure Vac and frequency

Measure VAC and verify voltage is within local grid standards.

- 1). Measure each phase to ground (L-G).
- 2). Measure phases to the other phases in pairs (L-L). PH A to PH B, PH B to PH C and PH C to PH A.
- 3). If the meter is equipped, measure the frequency of each phase to ground.
- 4). Ensure each measurement is within local grid standards and the inverter specifications as noted in section 10 "Specifications".

5.4.4.2 Phase rotation test

A phase rotation test is recommended to ensure the phases have been connected in the appropriate order. Solis inverters do not require a specific phase rotation connection. However, the local utility may require a specific phase rotation or a record of the phase configuration of the installation.

6. Start and Shutdown

6.1 Start-up procedure

To start-up the inverter, it is mandatory that the steps below are followed in the exact order outlined.

- 1). Ensure the commissioning checks in Section 5 have been performed.
- 2). Switch the AC switch ON.
- 3). Switch the DC switch ON. If the PV array (DC) voltage is higher than the inverter's start-up voltage, the inverter will turn on. The red DC POWER LED and LCD will be continuously lit.
- 4). Solis inverters are powered from the DC side. When the inverter detects DC power that is within start-up and operating ranges, the inverter will turn on. After turn-on, the inverter will check internal parameters, sense and monitor AC voltage, hertz rate and the stability of the supply grid. During this period, the green OPERATION LED will flash and the LCD screen will show INITIALIZING. This tells the operator that the inverter is preparing to generate AC power.
- 5). After the locally mandated delay (300 seconds for IEEE-1547 compliant inverters), the inverter will start generating AC power. The green OPERATION LED will light continuously and the LCD screen will show GENERATING.



CAUTION

The inverter's surface temperature can reach up to 75°C (167° F). To avoid risk of burns, do not touch the surface when the inverter is in the operational mode. Additionally, the inverter must be installed out of the reach of children.

6.2 Shutdown procedure

To stop the inverter, it is mandatory that the steps below are followed in the exact order outlined.

- 1). Select "Grid Off" in the Advanced Setting of Inverter LCD.
- 2). Turn off the AC Switch between Solis inverter and Grid.
- 3). Wait approximately 30 seconds (during this time, the AC side capacitors are dissipating energy). If the inverter has DC voltage above the start-up threshold, the red POWER LED will be lit. Switch the DC switch OFF.
- 4). Confirm all LED's switch OFF (~one (1) minute).



CAUTION

Although the inverter DC disconnect switch is in the OFF position and all the LED's are OFF, operators must wait five (5) minutes after the DC power source has been disconnected before opening the inverter cabinet. DC side capacitors can take up to five (5) minutes to dissipate all stored energy.

7. Normal operation

In normal operation, LCD screen alternatively shows inverter power and operation status (see Figure 7.1). The screen can be scrolled manually by pressing the UP/DOWN keys. Pressing the ENTER key gives access to Main Menu.

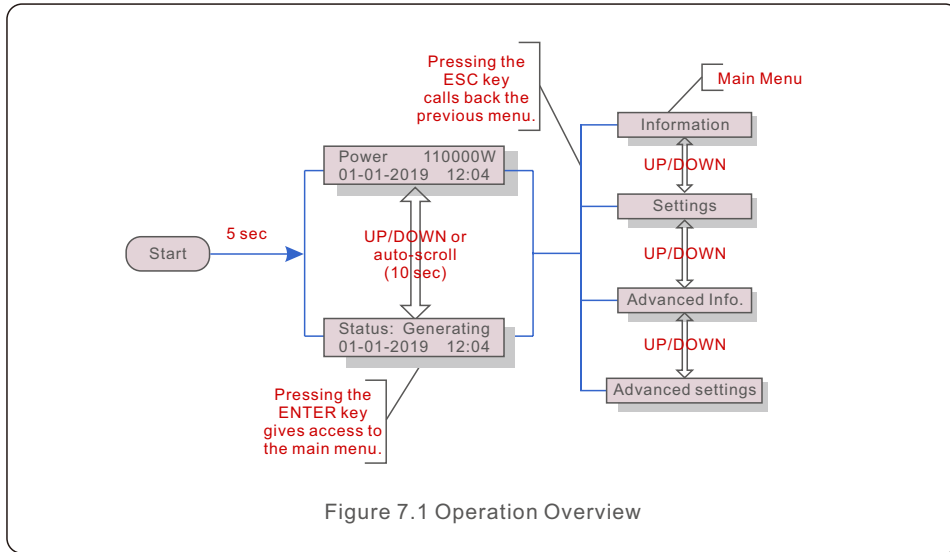

7.1 Main Menu

There are four submenus in the Main Menu (see Figure 7.1):

1. Information
2. Settings
3. Advanced Info.
4. Advanced Settings

7.2 Information

The Solis three Phase Inverter main menu provides access to operational data and information. The information is displayed by selecting "Information" from the menu and then by scrolling up or down.

7. Normal operation

Display	Duration	Description
VPV_Total: 1000.0V IPV_Total: +99.0A	10 sec	VPV_Total: Shows input voltage total. IPV_Total: Shows input current total.
V_A: 345.7V I_A: 109.0A	10 sec	V_A: Shows the grid's voltage value. I_A: Shows the grid's current value.
V_C: 345.0V I_C: 109.8A	10 sec	V_C: Shows the grid's voltage value. I_C: Shows the grid's current value.
Status: Generating Power: 1488W	10 sec	Status: Shows instant status of the Inverter. Power: Shows instant output power value.
Rea_Power: 000Var App_Power: VA	10 sec	Rea_Power: Shows the reactive power of the inverter. App_Power: Shows the apparent power of the inverter.
Grid Frequency F_Grid 50.06Hz	10 sec	F_Grid: Shows the grid's frequency value.
Total Energy 0258458 kwh	10 sec	Total generated energy value.
This Month: 0123kwh Last Month: 0123kwh	10 sec	This Month: Total energy generated this month. Last Month: Total energy generated last month.
Today: 15.1kwh Yesterday: 13.5kwh	10 sec	Today: Total energy generated today. Yesterday: Total energy generated yesterday.
Inverter SN 00000000000000	10 sec	Display series number of the inverter.
Work Mode: Volt-watt DRM NO.:08	10 sec	Work Mode: Shows current working mode. DRM NO.: Shows DRM Number.
I_DC01: +05.0A I_DC02: +04.9A ... I_DC20: +05.2A	10 sec	I_DC01 : Shows input 01 current value. I_DC02 : Shows input 02 current value. ... I_DC20 : Shows input 20 current value.

Table 7.1 Information list

7. Normal operation

7.2.1 Lock Screen

Pressing the ESC key returns to the Main Menu. Pressing the ENTER key locks (Figure 7.2(a)) or unlocks (Figure 7.2 (b)) the screen.

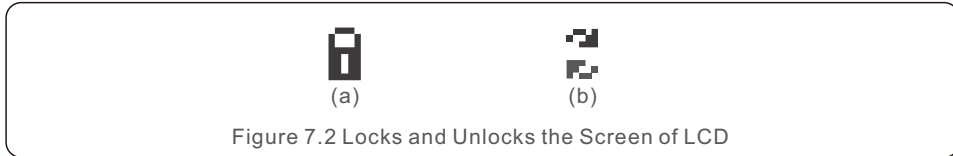

7.3 Settings

The following submenus are displayed when the Settings menu is selected:

1.Set Time

2.Set Address

7.3.1 Set Time

This function allows time and date setting. When this function is selected, the LCD will display a screen as shown in Figure 7.3.

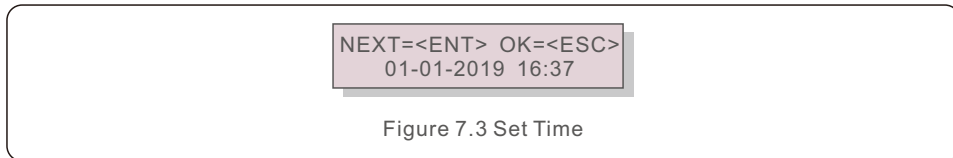

Press the UP/DOWN keys to set time and date. Press the ENTER key to move from one digit to the next (from left to right). Press the ESC key to save the settings and return to the previous menu.

7.3.2 Set Address

This function is used to set the address when muti inverters are connected to three monitor. The address number can be assigned from "01"to "99"(see Figure 7.4). The default address number of Solis Three Phase Inverter is "01".

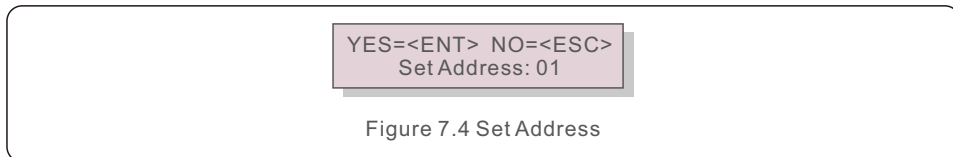

Press the UP/DOWN keys to set the address. Press the ENTER key to save the settings. Press the ESC key to cancel the change and return to the previous menu.

7. Normal operation

7.4 Advanced Info - Technicians Only

NOTE:
To access to this area is for fully qualified and accredited technicians only. Enter menu "Advanced Info." and "Advanced settings" (need password).

Select "Advanced Info." from the Main Menu. The screen will require the password as below:

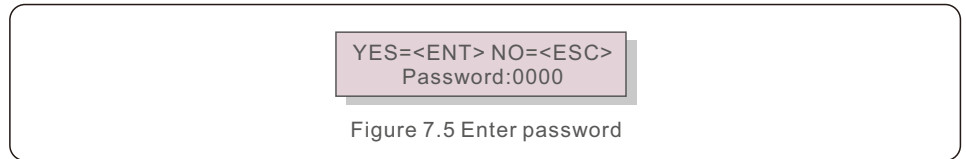

The default password is "0010".

Please press "down" to move the cursor, press "up" to select the number.

After enter the correct password the Main Menu will display a screen and be able to access to the following information.

- 1.Alarm Message
- 2. Running message
- 3.Version
- 4. Daily Energy
- 5. Monthly Energy
- 6. Yearly Energy
- 7. Daily Records
- 8.Communication Data
- 9. Warning Message

7.4.1 Alarm Message

The display shows the 100 latest alarm messages (see Figure 7.6). Screens can be scrolled manually by pressing the UP/ DOWN keys. Press the ESC key to return to the previous menu.

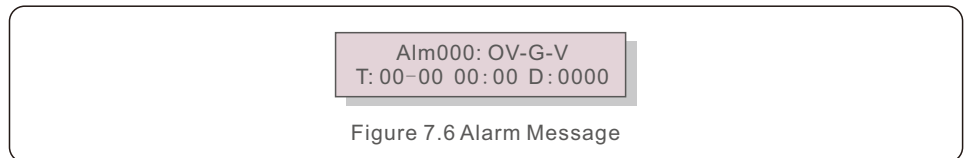

7.4.2 Running Message

This function is for maintainece person to get running message such as internal temperature, Standard No.1,2,etc.

Screens can be scrolled manually by pressing the UP/DOWN keys. Press UP/DOWN key to move one date from another.

7. Normal operation

7.4.3 Version

The screen shows the model version of the inverter. And the screen will show the software ver by pressing the UP and DOWN at the same time. (see Figure 7.7).



Model: 08
Software Version: D20001

Figure 7.7 Model Version and Software Version

7.4.4 Daily Energy

The function is for checking the energy generation for selected day.



YES=<ENT> NO=<ESC>
Select: 2019-01-01

Figure 7.8 Select date for daily energy

Press DOWN key to move the cursor to day, month and year, press UP key to change the digit. Press Enter after the date is fixed.

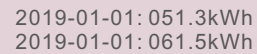

2019-01-01: 051.3kWh
2019-01-01: 061.5kWh

Figure 7.9 Daily energy

Press UP/DOWN key to move one date from another.

7.4.5 Monthly Energy

The function is for checking the energy generation for selected month.



YES=<ENT> NO=<ESC>
Select: 2019-01

Figure 7.10 Select month for monthly energy

Press DOWN key to move the cursor to day and month, press UP key to change the digit. Press Enter after the date is fixed.

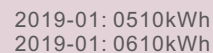

2019-01: 0510kWh
2019-01: 0610kWh

Figure 7.11 Month energy

7. Normal operation

7.4.6 Yearly Energy

The function is for checking the energy generation for selected year.



YES=<ENT> NO=<ESC>
Select: 2019

Figure 7.12 Select year for yearly energy

Press DOWN key to move the cursor to day and year, press UP key to change the digit. Press Enter after the date is fixed.

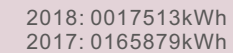

2018: 0017513kWh
2017: 0165879kWh

Figure 7.13 Yearly energy

Press UP/DOWN key to move one date from another.

7.4.7 Daily Records

The screen shows history of changing settings. Only for maintenance personnel.

7.4.8 Communication Data

The screen shows the internal data of the Inverter (see Figure 7.14), which is for service technicians only.

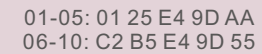

01-05: 01 25 E4 9D AA
06-10: C2 B5 E4 9D 55

Figure 7.14 Communication Data

7.4.9 Warning Message

The display shows the 100 latest warn messages (see Figure 7.15). Screens can be scrolled manually by pressing the UP/ DOWN keys. Press the ESC key to return to the previous menu.



Msg000:
T: 00-00 00:00 D: 0000

Figure 7.15 Warning Message

7. Normal operation

7.5 Advanced Settings - Technicians Only



NOTE:

To access this area is for fully qualified and accredited technicians only. Please follow 7.4 to enter password to access this menu.

Select Advanced Settings from the Main Menu to access the following options:

1. Select Standard
2. Grid ON/OFF
3. Clear Energy
4. Reset Password
5. Power Control
6. Calibrate Energy
7. Special Settings
8. STD. Mode Settings
9. Restore Settings
10. HMI Update
11. External EPM Set
12. Restart HMI
13. Debug Parameter
14. Fan Test
15. DSP Update
16. Compensation Set
17. I/V Curve

7.5.1 Selecting Standard

This function is used to select the grid's reference standard (see Figure 7.16).

→ YES=<ENT> NO=<ESC>
Standard:G99

Figure 7.16

Selecting the "User-Def" menu will access to the following submenu (see Figure 7.17),

→ OV-G-V1: 400V
OV-G-V1-T: 1.0S

Figure 7.17

Below is the setting range for "User-Def". Using this function, the limits can be changed manually. (These voltage values are the phase voltage)

7. Normal operation

OV-G-V1: 220---374V	OV-G-F1: 50.1-65Hz
OV-G-V1-T: 0.01---300S	OV-G-F1-T: 0.01---300S
OV-G-V2: 220---374V	OV-G-F2: 50.1-65Hz
OV-G-V2-T: 0.01---300S	OV-G-F2-T: 0.01---300S
UN-G-V1: 110---277V	UN-G-F1: 45-59.9Hz
UN-G-V1-T: 0.01---300S	UN-G-F1-T: 0.01---300S
UN-G-V2: 110---277V	UN-G-F2: 45-59.9Hz
UN-G-V2-T: 0.01---300S	UN-G-F2-T: 0.01---300S
Startup-T: 10-600S	Restore-T: 10-600S

Table 7.2 Ranges for User-Def

OV-G-V1: 120---180V	OV-G-F1: 50.2-53Hz(60.2-63Hz)
OV-G-V1-T: 0.1---9S	OV-G-F1-T: 0.1---9S
OV-G-V2: 120---180V	OV-G-F2: 51-53Hz(61-63Hz)
OV-G-V2-T: 0.1---1S	OV-G-F2-T: 0.1---9S
UN-G-V1: 55---121V	UN-G-F1: 47-49.5Hz(57-59.5Hz)
UN-G-V1-T: 0.1---9S	UN-G-F1-T: 0.1---9S
UN-G-V2: 55---121V	UN-G-F2: 47-59Hz(57-59Hz)
UN-G-V2-T: 0.1---1S	UN-G-F2-T: 0.1---9S
Startup-T: 10-600S	Restore-T: 10-600S

Table 7.3 Ranges for User-Def (50-75)K-LV



NOTE

The initial value of the User-Def standard is for reference only. It does not represent a correct value suitable for use.



NOTE

For different countries, the grid standard needs to be set as different according to local requirements. If there is any doubt, please consult Solis service technicians for details.

7.5.2 Grid ON/OFF

This function is used to start up or stop the power generation of Solis Three Phase Inverter.

→ Grid ON
Grid OFF

Figure 7.18 Set Grid ON/OFF

7. Normal operation

7.5.3 Clear Energy

Clear Energy can reset the history yield of inverter



These two functions are applicable by maintenance personnel only, wrong operation will prevent the inverter from working properly.

7.5.4 Reset Password

This function is used to set the new password for menu "Advanced info." and "Advanced information" (see Figure 7.19).

YES=<ENT> NO=<ESC>
Password: 0000

Figure 7.19 Set new password

Enter the right password before set new password. Press the DOWN key to move the cursor, Press the UP key to revise the value. Press the ENTER key to execute the setting. Press the ESC key to return to the previous menu.

7.5.5 Power Control

Active and reactive power can be set through power setting button.

There are 5 item for this sub menu:

1. Set output power
2. Set Reactive Power
3. Out_P With Restore
4. Rea_P With Restore
5. Select PF Curve



This function is applicable by maintenance personnel only, wrong operation will prevent the inverter from reaching maximum power.

7.5.6 Calibrate Energy

Maintenance or replacement could clear or cause a different value of total energy. Use this function could allow user to revise the value of total energy to the same value as before. If the monitoring website is used the data will be synchronous with this setting automatically.

7. Normal operation

YES=<ENT> NO=<ESC>
Energy:0000000kWh

Figure 7.20 Calibrate energy

Press the DOWN key to move the cursor. Press the UP key to revise the value. Press the ENTER key to execute the setting. Press the ESC key to return to the previous menu.

7.5.7 Special Settings



This function is applicable by maintenance personnel only, wrong operation will prevent the inverter from reaching maximum power.

7.5.8 STD Mode Settings

Selecting "STD Mode. Settings" displays the sub-menu shown below:

1. Working Mode Set
2. Power Rate Limit
3. Freq Derate Set
4. 10mins Voltage Set
5. Power Priority
6. Initial Settings
7. Voltage PCC Set



This function is applicable by maintenance personnel only, wrong operation will prevent the inverter from reaching maximum power.

7.5.8.1 Enable logic interface settings

Please follow below settings to enable the **DRM**. DRM default setting is "OFF", if DRM set "ON", but the logic interface un-connected to the switch or the switch is open, the inverter HMI will display "Limit by DRM" and the inverter output power will be limited to zero.

1. Select **Initial Settings**
2. Select **DRM** and set it "ON"

7. Normal operation

7.5.9 Restore Settings

There are 5 items in initial setting submenu.
Restore setting could set all item in 7.5.7 special setting to default.
The screen shows as below:

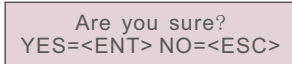

Figure 7.21 Restore Settings

Press the Enter key to save the setting after setting grid off.
Press the ESC key to return the previous mean.

7.5.10 HMI Update



This section is applicable to maintenance personnel only.

Selecting "Updater" displays the sub-menu shown below:



Figure 7.22

Updater is for updating LCD firmware. Press the ENTER key to start the process.
Press the ESC key to return to the previous menu.

7.5.11 External EPM Set

This function is turned on when the EPM is external.
Path : Advanced Setting -> External EPM Set -> 5G-EPM
If you directly connect the inverter using the EPM without turning on the switch, the inverter does not refresh data.



Figure 7.23 Set the Fail Safe ON/OFF

7. Normal operation

7.5.12 Restart HMI

The function is used for restart the HMI.



This function is applicable by maintenance personnel only, wrong operation will prevent the inverter from reaching maximum power.

7.5.13 Debug Parameter



This section is applicable to maintenance personnel only.

Debug Parameter as shown as below:

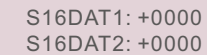

Figure 7.24

Press the UP/DOWN keys to scroll through items. Press the ENTER key to select.
Press the DOWN key to scroll and press the UP key to change the value.
Press the ENTER key to save the setting. Press the ESC key to cancel changes and return to the previous menu.

7.5.14 FAN Test



This section is applicable to maintenance personnel only.

Selecting "Fan Test" displays the sub-menu shown below:

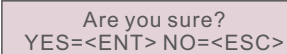

Figure 7.25

Fan Test is a factory test function. Press the ENTER key to start the test.
Press the ESC key to return to the previous menu.

7. Normal operation

7.5.15 DSP Update

The function is used for update the DSP.



This function is applicable by maintenance personnel only, wrong operation will prevent the inverter from reaching maximum power.

7.5.16 Compensation Set

This function is used to calibrate inverter output energy and voltage. It will not impact the energy count for inverter with RGM.

Two sections are included: Power Parameter and Voltage Parameter.

The screen shows:

```
YES=<ENT> NO=<ESC>
Power para: 1.000
```

Figure 7.26 Power Rate Limit

Press the Down key to move the cursor.

Press the Up key to change the digit.

Please press the Enter to save the setting and press the ESC key to return to the previous menu.



This setting is used for grid operators, do not change this setting unless specifically instructed to.

7.5.17 I/V Curve

This function is used to scan the I/V characteristic curves of each PV strings.

```
→ Set I/V Curve
I/V Curve Scan
```

Figure 7.27 I/V Curve

7. Normal operation

7.5.17.1 Set I/V Curve

This setting can set the scanning voltage start point and the voltage interval.

```
Start_V: 850V
Interval_V: 010V
```

Figure 7.28 Set I/V Curve

Start_V: The start voltage of the I/V scan. (Adjustable from 300V-1000V)

Interval_V: The scanning voltage interval. (Adjustable from 1-100V)

In total, 60 data points can be scanned.

7.5.17.2 I/V Curve Scan

Press "ENT" to start the I/V curve scan.

```
Scanning...01
```

Figure 7.29 I/V Curve Scan (1)

After it is completed, the screen will display "Scan OK" and then enter the following section.

```
Select String No.: 01
```

Figure 7.30 I/V Curve Scan (2)

```
01_850V: 9.56A
02_860V: 9.44A
```

Figure 7.31 I/V Curve Scan (3)

7. Normal operation

7.6 AFCI function

Solis inverters have the built-in AFCI function which can detect the arc fault on the DC circuit and shut down the inverter to prevent a fire disaster.

7.6.1 Enable the AFCI function

The AFCI function can be enabled in the following.

Path: Advanced Setting -> Password: 0010 ->Special Settings -> AFCI Set ->

AFCI ON/OFF -> ON

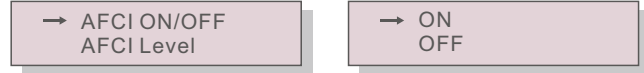

Figure 7.32 Set AFCI



Warning:

The "AFCI Level" is reserved for Solis technicians ONLY. Do not change the sensitivity otherwise it will lead to frequent false alarms or malfunctions. Solis is not responsible for any further damages caused by unauthorized modifications.



NOTE:

The setting corresponds to the current status as well which can be used to inspect the ON/OFF state of the AFCI function.

7.6.2 Arc Fault

During the normal operation, if an DC arc is detected, the inverter will shut down and give out the following alarm:



Figure 7.33 Arc Fault

Installer needs to thoroughly inspect the DC circuit to ensure all the cables are correctly fastened.

Once the DC circuit issue has been fixed or it is confirmed to be OK, press "ESC" for 3s and wait for the inverter to restart.

8. Maintenance

Solis Three Phase Inverter does not require any regular maintenance. However, cleaning the dust on heat-sink will help the inverter to dissipate the heat and increase its life time. The dust can be removed with a soft brush.



CAUTION:

Do not touch the inverter's surface when it is operating. Some parts of the inverter may be hot and cause burns. Turn off the inverter (refer to Section 6.2) and wait for a cool-down period before any maintenance or cleaning operation.

The LCD and the LED status indicator lights can be cleaned with a damp cloth if they are too dirty to be read.



NOTE:

Never use any solvents, abrasives or corrosive materials to clean the inverter.

8.1 Anti-PID Function

Solis Three phase Inverters integrates optional Anti-PID module and it can recover the PID effect during night thus protect the PV system from degradation.

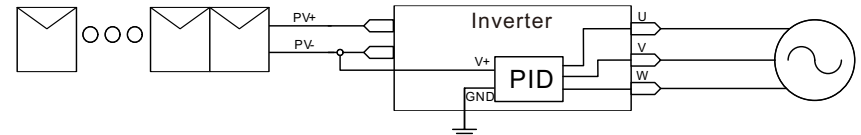

Figure 8.1

The Anti-PID module repairs the PID effect of the PV model at night. When operating, the inverter LCD screen displays "PID-repairing" information, and the red light is on. The Anti-PID function is always ON when AC is applied.

If maintenance is required and turn off the AC switch can disable the Anti-PID function.



WARNING :

The PID function is automatic. When the DC bus voltage is lower than 50Vdc, the PID module will start creating 450 Vdc between PV- and ground. No need any control or settings



NOTE:

If you need to maintain the inverter at night, please turn off the AC switch first, then turn off the DC switch, and wait 5 minutes before you do other operations.

8. Maintenance

8.2 Fan Maintenance

If the fan does not work properly, the inverter will not be cooled effectively and it may affect the effective operation of the inverter .

Therefore, it is necessary to clean or replace a broken fan as follows:

1. Turn off the "Grid ON/OFF" switch on the inverter LCD.
2. Disconnect the AC power.
3. Turn the DC switch to "OFF" position.
4. Wait for 15 minutes at least.
5. Remove the 4 screws on the fan plate and pull out the fan assembly slowly.

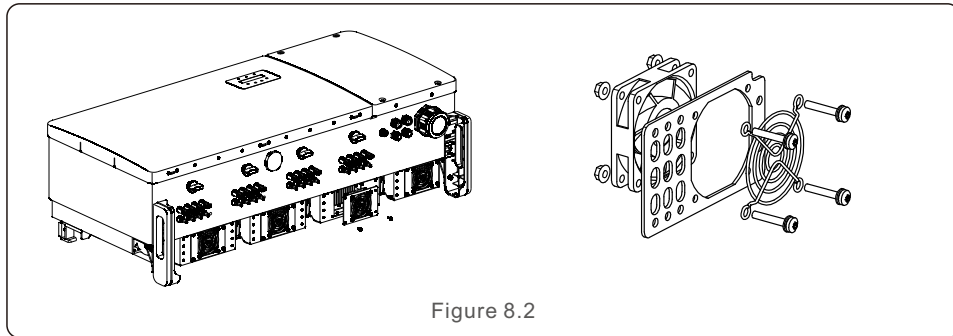

Figure 8.2

6. Disconnect the fan connector carefully and take out the fan.
7. Clean or replace the fan. Assemble the fan on the rack.
8. Connect the electrical wire and reinstall the fan assembly. Restart the inverter.

8.3 Smart O&M

In order to improve our products and provide you with higher quality services, this device has a built-in data logging module for collecting relevant information during operation (such as power generation data, fault data)

Commitment:

1. We will only collect, use and process your device information for the purpose of improving our products and services.
2. We will take all reasonable and feasible measures to ensure that no irrelevant information is collected and we will protect your device information.
3. We will not share, transfer or disclose the collected device information with any company, organization or individual.
4. When we stop operating products or services, we will stop collecting your device information in a timely manner.
5. If you do not want to provide such information, you can notify our company to turn off this function, which will not affect your normal use of other functions of the product.

9. Troubleshooting

The inverter is designed in accordance with the most important international grid-tied standards and safety and electromagnetic compatibility requirements. Before delivering to the customer, the inverter has been subjected to several tests to ensure its optimal operation and reliability.

In case of failure, the LCD screen will display an alarm message. In this case, the inverter may stop feeding into the grid. The failure descriptions and their corresponding alarm messages are listed in Table 9.1:

Alarm Message	Failure description	Solution
No power	Inverter no power on LCD	1.Check PV input connections 2.Check DC input voltage (single phase >120V, three phase >350V) 3.Check if PV+/- is reversed
LCD show initializing all the time	Can not start-up	1.Check if the connector on main board or power board are fixed. 2.Check if the DSP connector to power board are fixed.
OV-G-V01/02/03/04	Over grid voltage	1.Resistant of AC cable is too high. Change bigger size grid cable 2.Adjust the protection limit if it's allowed by electrical company.
UN-G-V01/02	Under grid voltage	1.Use user define function to adjust the protection limit if it's allowed by electrical company.
OV-G-F01/02	Over grid frequency	
UN-G-F01/02	Under grid frequency	
G-IMP	High grid impedance	
NO-GRID	No grid voltage	1.Check connections and grid switch. 2.Check the grid voltage inside inverter terminal.
OV-DC01/02/03/04	Over DC voltage	1.Reduce the module number in series
OV-BUS	Over DC bus voltage	1.Check inverter inductor connection 2.Check driver connection
UN-BUS01/02	Under DC bus voltage	
GRID-INTF01/02	Grid interference	1.Restart inverter 2.Change power board
OV-G-I	Over grid current	
IGBT-OV-I	Over IGBT current	
DC-INTF OV-DCA-I	DC input overcurrent	1.Restart inverter 2.Identify and remove the string to the fault MPPT 2.Change power board
IGFOL-F	Grid current tracking fail	1.Restart inverter or contact installer.
IG-AD	Grid current sampling fail	
OV-TEM	Over Temperature	1.Check inverter surrounding ventilation. 2.Check if there's sunshine direct on inverter in hot weather.

9. Troubleshooting

9. Troubleshooting

Alarm Message	Failure description	Solution
INI-FAULT	Initialization system fault	1.Restart inverter or contact installer.
DSP-B-FAULT	Comm. failure between main and slave DSP	
12Power-FAULT	12V power supply fault	
PV ISO-PRO 01/02	PV isolation protection	1.Remove all DC input, reconnect and restart inverter one by one. 2.Identify which string cause the fault and check the isolation of the string.
lLeak-PRO 01/02/03/04	Leakage current protection	1.Check AC and DC connection 2.Check inverter inside cable connection.
RelayChk-FAIL	Relay check fail	1.Restart inverter or contact installer.
DCinj-FAULT	High DC injection current	
AFCI self-detection (model with AFCI module)	AFCI module self-detect fault	1.Restart inverter or connect technician.
Arcing protection (model with AFCI module)	Detect arc in DC circuit	1. Check inverter connection whether arc exists and restart inverter.
Reve-DC	One of the DC string is reversely connected	1. Please check the inverters' PV string polarity, if there are strings reversely connected wait for the night when the solar irradiance is low and the PV string current down below 0.5A. Turn off the two DC switches and fix the polarity issue.
Screen OFF with DC applied	Inverter internally damaged	1.Do not turn off the DC switches as it will damage the inverter. 2.Please wait for the solar irradiance reduces and confirm the string current is less than 0.5A with a clip-on ammeter and then turn off the DC switches. 3.Please note that any damages due to wrong operations are not covered in the device warranty.

Table 9.1 Fault message and description



NOTE

If the inverter displays any alarm message as listed in Table 9.1, please turn off the inverter (refer to Section 6.2 to stop your inverter) and wait for 15 minutes before restarting it (refer to Section 6.1 to start your inverter). If the failure persists, please contact your local distributor or the service center. Please keep ready with you the following information before contacting us.

1. Serial number of Solis Three Phase Inverter;
2. The distributor/dealer of Solis Three Phase Inverter (if available);
3. Installation date.
4. The description of problem (i.e. the alarm message displayed on the LCD and the status of the LED status indicator lights. Other readings obtained from the Information submenu (refer to Section 6.2) will also be helpful.);
5. The PV array configuration (e.g. number of panels, capacity of panels, number of strings, etc.);
6. Your contact details.

10. Specifications

Model	Solis-75K-5G-PRO
Max. DC input voltage (Volts)	1100
Rated DC voltage (Volts)	600
Start-up voltage (Volts)	180
MPPT voltage range (Volts)	160...1000
Max. input current (Amps)	40A/32A/40A/32A/40A/32A
Max. short circuit current of each MPPT (Amps)	50
MPPT number/Max input strings number	6/12
Rated output power (Watts)	75000
Max. output power (Watts)	75000
Max. apparent output power (VA)	75000
Rated grid voltage (Volts)	3/N/PE, 220/380, 230/400
Rated grid output current (Amps)	114
Max. output current (Amps)	114
Power Factor (at rated output power)	0.8leading~0.8lagging
THDi (at rated output power)	<3%
Rated grid frequency (Hertz)	50/60
Max. efficiency	98.5%
EU efficiency	98.0%
Dimensions (W*H*D)	1065* 585 * 363 mm(with AC switch)
Weight	79.5kg
Topology	Transformerless
Self consumption (night)	< 2W
Operating ambient temperature range	-30°C...+60°C
Relative humidity	0~100%
Ingress protection	IP66
Cooling concept	Intelligent redundant cooling
Max. operation altitude	4000m
Grid connection standard	IEC61727
Safety/EMC standard	IEC/EN 62109-1/-2, IEC/EN 61000-6-2/-4
DC connection	MC4 connector
AC connection	OT Terminal (max 185 mm ²)
Display	LCD, 2×20 Z
Communication connections	RS485, Optional: Wifi, GPRS , PLC
Warranty	5 years (extend to 20 years)

10. Specifications

Model	Solis-80K-5G-PRO
Max. DC input voltage (Volts)	1100
Rated DC voltage (Volts)	600
Start-up voltage (Volts)	180
MPPT voltage range (Volts)	160...1000
Max. input current (Amps)	40A/32A/40A/32A/40A/32A
Max. short circuit current of each MPPT (Amps)	50
MPPT number/Max input strings number	6/12
Rated output power (Watts)	80000
Max. output power (Watts)	88000
Max. apparent output power (VA)	88000
Rated grid voltage (Volts)	3/N/PE, 220/380, 230/400
Rated grid output current (Amps)	121.6/115.5
Max. output current (Amps)	133.7
Power Factor (at rated output power)	0.8leading~0.8lagging
THDi (at rated output power)	<3%
Rated grid frequency (Hertz)	50/60
Max. efficiency	98.5%
EU efficiency	98.0%
Dimensions (W*H*D)	1065* 585 * 363 mm(with AC switch)
Weight	79.5kg
Topology	Transformerless
Self consumption (night)	< 2W
Operating ambient temperature range	-30°C...+60°C
Relative humidity	0~100%
Ingress protection	IP66
Cooling concept	Intelligent redundant cooling
Max. operation altitude	4000m
Grid connection standard	G99, IEC61727, EN50549-1/2, VDE4110
Safety/EMC standard	IEC/EN 62109-1/-2, IEC/EN 61000-6-2/-4
DC connection	MC4 connector
AC connection	OT Terminal (max 185 mm ²)
Display	LCD, 2×20 Z
Communication connections	RS485, Optional: Wifi, GPRS , PLC
Warranty	5 years (extend to 20 years)

10. Specifications

Model	Solis-100K-5G-PRO
Max. DC input voltage (Volts)	1100
Rated DC voltage (Volts)	600
Start-up voltage (Volts)	180
MPPT voltage range (Volts)	160...1000
Max. input current (Amps)	40A/32A/40A/32A/40A/32A/40A/32A
Max. short circuit current of each MPPT (Amps)	50
MPPT number/Max input strings number	8/16
Rated output power (Watts)	100000
Max. output power (Watts)	110000
Max. apparent output power (VA)	110000
Rated grid voltage (Volts)	3/N/PE, 220/380, 230/400
Rated grid output current (Amps)	152.0/144.3
Max. output current (Amps)	167.1
Power Factor (at rated output power)	0.8leading~0.8lagging
THDi (at rated output power)	<3%
Rated grid frequency (Hertz)	50/60
Max. efficiency	98.5%
EU efficiency	98.0%
Dimensions (W*H*D)	1183* 585 * 363 mm
Weight	93kg
Topology	Transformerless
Self consumption (night)	< 2W
Operating ambient temperature range	-30°C...+60°C
Relative humidity	0~100%
Ingress protection	IP66
Cooling concept	Intelligent redundant cooling
Max. operation altitude	4000m
Grid connection standard	G99, IEC61727, EN50549-1/2, VDE4110
Safety/EMC standard	IEC/EN 62109-1/-2, IEC/EN 61000-6-2/-4
DC connection	MC4 connector
AC connection	OT Terminal (max 185 mm ²)
Display	LCD, 2×20 Z
Communication connections	RS485, Optional: Wifi, GPRS , PLC
Warranty	5 years (extend to 20 years)

10. Specifications

Model	Solis-110K-5G-PRO
Max. DC input voltage (Volts)	1100
Rated DC voltage (Volts)	600
Start-up voltage (Volts)	180
MPPT voltage range (Volts)	160...1000
Max. input current (Amps)	40A/32A/40A/32A/40A/32A/40A/32A
Max. short circuit current of each MPPT (Amps)	50
MPPT number/Max input strings number	8/16
Rated output power (Watts)	110000
Max. output power (Watts)	121000
Max. apparent output power (VA)	121000
Rated grid voltage (Volts)	3/N/PE, 220/380, 230/400
Rated grid output current (Amps)	167.1/158.8
Max. output current (Amps)	183.8
Power Factor (at rated output power)	0.8leading~0.8lagging
THDi (at rated output power)	<3%
Rated grid frequency (Hertz)	50/60
Max. efficiency	98.5%
EU efficiency	98.0%
Dimensions (W*H*D)	1183* 585 * 363 mm
Weight	93kg
Topology	Transformerless
Self consumption (night)	< 2W
Operating ambient temperature range	-30°C...+60°C
Relative humidity	0~100%
Ingress protection	IP66
Cooling concept	Intelligent redundant cooling
Max. operation altitude	4000m
Grid connection standard	G99, IEC61727, EN50549-1/2, VDE4110
Safety/EMC standard	IEC/EN 62109-1/-2, IEC/EN 61000-6-2/-4
DC connection	MC4 connector
AC connection	OT Terminal (max 185 mm ²)
Display	LCD, 2×20 Z
Communication connections	RS485, Optional: Wifi, GPRS , PLC
Warranty	5 years (extend to 20 years)

10. Specifications

Model	Solis-50K-LV-5G-PRO
Max. DC input voltage (Volts)	800
Rated DC voltage (Volts)	450
Start-up voltage (Volts)	180
MPPT voltage range (Volts)	160...800
Max. input current (Amps)	8*20
Max. short circuit current of each MPPT (Amps)	50
MPPT number/Max input strings number	8/8
Rated output power (Watts)	50000
Max. output power (Watts)	55000
Max. apparent output power (VA)	55000
Rated grid voltage (Volts)	3/(N)/PE, 220
Rated grid output current (Amps)	131.2
Max. output current (Amps)	144.3
Power Factor (at rated output power)	0.8leading~0.8lagging
THDi (at rated output power)	<3%
Rated grid frequency (Hertz)	50/60
Max. efficiency	98.5%
EU efficiency	98.0%
Dimensions (W*H*D)	1183* 585 * 363 mm
Weight	93kg
Topology	Transformerless
Self consumption (night)	< 2W
Operating ambient temperature range	-30°C...+60°C
Relative humidity	0~100%
Ingress protection	IP66
Cooling concept	Intelligent redundant cooling
Max.operation altitude	4000m
Grid connection standard	IEC 61727, IEC 62116, C10/11, VDE 4105, IIEEE 1547
Safety/EMC standard	IEC/EN 62109-1/-2, IEC/EN 61000-6-2/-4
DC connection	MC4 connector
AC connection	OT Terminal (max 185 mm ²)
Display	LCD, 2×20 Z
Communication connections	RS485, Optional: Wifi, GPRS , PLC
Warranty	5 years (extend to 20 years)

10. Specifications

Model	Solis-60K-LV-5G-PRO
Max. DC input voltage (Volts)	800
Rated DC voltage (Volts)	450
Start-up voltage (Volts)	180
MPPT voltage range (Volts)	160...800
Max. input current (Amps)	12*20
Max. short circuit current of each MPPT (Amps)	50
MPPT number/Max input strings number	8/12
Rated output power (Watts)	60000
Max. output power (Watts)	66000
Max. apparent output power (VA)	66000
Rated grid voltage (Volts)	3/(N)/PE, 220
Rated grid output current (Amps)	157.5
Max. output current (Amps)	173.2
Power Factor (at rated output power)	0.8leading~0.8lagging
THDi (at rated output power)	<3%
Rated grid frequency (Hertz)	50/60
Max. efficiency	98.5%
EU efficiency	98.0%
Dimensions (W*H*D)	1183* 585 * 363 mm
Weight	93kg
Topology	Transformerless
Self consumption (night)	< 2W
Operating ambient temperature range	-30°C...+60°C
Relative humidity	0~100%
Ingress protection	IP66
Cooling concept	Intelligent redundant cooling
Max.operation altitude	4000m
Grid connection standard	IEC 61727, IEC 62116, C10/11, VDE 4105, IIEEE 1547
Safety/EMC standard	IEC/EN 62109-1/-2, IEC/EN 61000-6-2/-4
DC connection	MC4 connector
AC connection	OT Terminal (max 185 mm ²)
Display	LCD, 2×20 Z
Communication connections	RS485, Optional: Wifi, GPRS , PLC
Warranty	5 years (extend to 20 years)

10. Specifications

Model	Solis-75K-LV-5G-PRO
Max. DC input voltage (Volts)	800
Rated DC voltage (Volts)	450
Start-up voltage (Volts)	180
MPPT voltage range (Volts)	160...800
Max. input current (Amps)	12*20
Max. short circuit current of each MPPT (Amps)	50
MPPT number/Max input strings number	8/12
Rated output power (Watts)	75000
Max. output power (Watts)	75000
Max. apparent output power (VA)	75000
Rated grid voltage (Volts)	3/(N)/PE, 220
Rated grid output current (Amps)	196.8
Max. output current (Amps)	196.8
Power Factor (at rated output power)	0.8leading~0.8lagging
THDi (at rated output power)	<3%
Rated grid frequency (Hertz)	50/60
Max. efficiency	98.5%
EU efficiency	98.0%
Dimensions (W*H*D)	1183* 585 * 363 mm
Weight	93kg
Topology	Transformerless
Self consumption (night)	< 2W
Operating ambient temperature range	-30°C...+60°C
Relative humidity	0~100%
Ingress protection	IP66
Cooling concept	Intelligent redundant cooling
Max.operation altitude	4000m
Grid connection standard	IEC 61727, IEC 62116, C10/11, VDE 4105, IEEE 1547
Safety/EMC standard	IEC/EN 62109-1/-2, IEC/EN 61000-6-2/-4
DC connection	MC4 connector
AC connection	OT Terminal (max 185 mm ²)
Display	LCD, 2×20 Z
Communication connections	RS485, Optional: Wifi, GPRS , PLC
Warranty	5 years (extend to 20 years)