

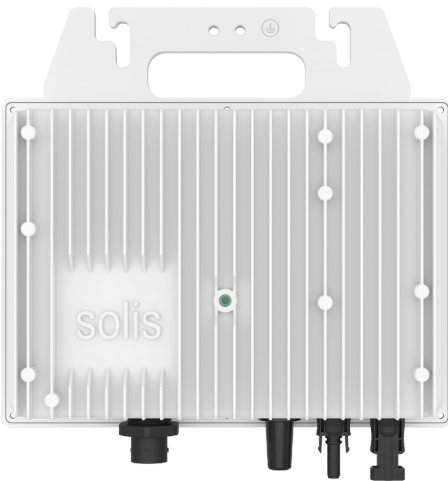

User Manual

for S6 Series Grid Inverter



Applicable models
S6-GR1P0.8K-UM

Applicable System
Single phase system

Contents

1. Introduction	3
1.1 Product Description	3
1.2 Packaging	4
1.3 Product Storage	5
2. Safety Instructions	6
2.1 Safety Symbols	6
2.2 General Safety Instructions	6
2.3 Notice For Use	8
2.4 Notice for Disposal	8
3. Overview	9
3.1 Front Panel Display	9
3.2 LED Status Indicator Lights	9
4. Installation	10
4.1 System Diagram	10
4.2 Mounting the Inverter	11
4.3 External ground connection	12
4.4 Electrical Connections	12
4.4.1 Connect grid side of inverter	13
4.4.2 Connect PV side of inverter	15
4.5 Max. over current protection device (OCPD)	19
5. Commissioning	20
5.1 Preparation	20
5.2 APP Download	20
5.3 Log in the APP via bluetooth	21
5.4 Stop the Inverter	24

Contents

- 6. Operation 25
 - 6.1 Home Page 25
 - 6.2 Info Page 26
 - 6.3 Alarm Page 27
 - 6.4 Setting Page 28
- 7. Maintenance 29
- 8. Specifications 30

1.1 Product Description

Solis 800W Utral Mini series is for private applications for balconies, terraces, garages or outdoor installations. It converts the electricity generated by photovoltaics into alternating current that meets the requirements of the grid and feeds directly into your existing grid.

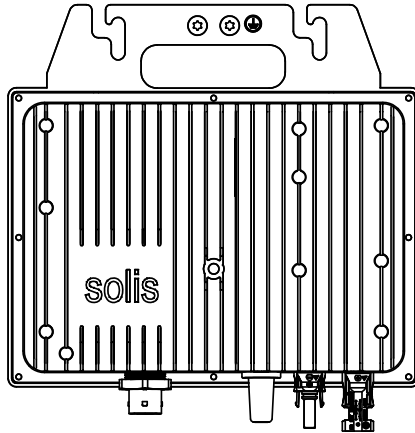

Figure 1.1 Front view

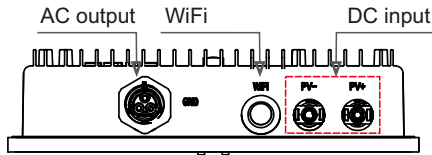
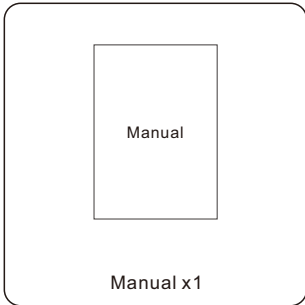
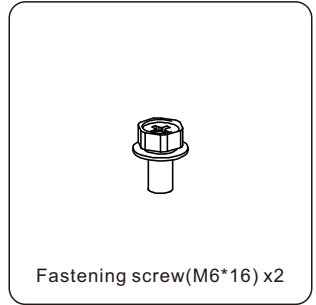
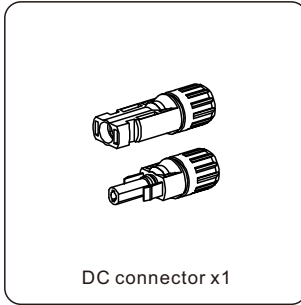
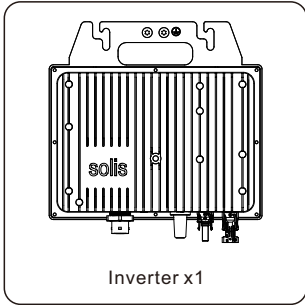

Figure 1.2 Bottom view

1.2 Packaging

When you receive the inverter, please ensure that all the parts listed below are included:



If anything is missing, please contact your local Solis distributor.

1.3 Product Storage

If the inverter is not to be installed immediately, storage instructions and environmental conditions are below:

- Use the original box to repackage the inverter, seal with adhesive tape with the desiccant inside the box.
- Store the inverter(s) in a clean and dry place, free of dust and dirt.
- Storage temperature must be between -40°C and 70°C and the humidity should be between 0 and 95% non-condensing.
- Stack no more than eleven (11) inverters high.
- Keep box(es) away from corrosive materials to avoid damage to the inverter enclosure.
- Inspect packaging regularly. If packaging is damaged(wet, pest damage, etc), repackage the inverter immediately.
- Store the inverter(s) on a flat, hard surface - not inclined or upside down.
- After long-term storage, the inverter needs to be fully examined and tested by qualified service or technical personnel before using.
- Restarting after a long period of non-use requires the equipment to be inspected and, in some cases, the removal of oxidation and dust that has settled inside the equipment will be required.

2.1 Safety Symbols

Safety symbols used in this manual, which highlight potential safety risks and important safety information, are listed as follows:



WARNING:

WARNING symbol indicates important safety instructions, which if not correctly followed, could result in serious injury or death.



NOTE:

NOTE symbol indicates important safety instructions, which if not correctly followed, could result in some damage or the destruction of the inverter.



CAUTION:

CAUTION, RISK OF ELECTRIC SHOCK symbol indicates important safety instructions, which if not correctly followed, could result in electric shock.



CAUTION:

CAUTION, HOT SURFACE symbol indicates safety instructions, which if not correctly followed, could result in burns.

2.2 General Safety Instructions



WARNING:

Please don't connect PV array positive(+) or negative(-) to ground, it could cause serious damage to the inverter.



NOTE:

PV module used with inverter must have an IEC 61730 Class A rating.



WARNING:

Electrical installations must be done in accordance with the local and national electrical safety standards.



WARNING:

No live construction is allowed, and before installation, ensure that the equipment is in good condition.



WARNING:

Do not touch any inner live parts until 5 minutes after disconnection from the utility grid and the PV input.



CAUTION:

Risk of electric shock. Do not remove cover. There is no user serviceable parts inside. Refer servicing to qualified and accredited service technicians.



CAUTION:

The PV array (Solar panels) supplies a DC voltage when they are exposed to sunlight.



WARNING:

Destruction of the inverter due to overvoltage; Damage to the product due to ground fault on DC side during operation; Damage to the product due to sand, dust and moisture ingress if the DC inputs are not closed.



CAUTION:

The surface temperature of the inverter can exceed 75°C (167F). To avoid risk of burns, DO NOT touch the surface when inverter is operating. The inverter must be installed out of reach of children.



CAUTION:

Risk of electric shock from energy stored in capacitors of the Inverter. Do not remove cover for 5 minutes after disconnecting all power sources (service technician only). Warranty may be voided if the cover is removed without unauthorised.

2.3 Notice For Use

The inverter has been constructed according to the applicable safety and technical guidelines. Use the inverter in installations that meet the following specifications only:

1. Permanent installation is required.
2. All components must remain within their permitted operating ranges and their installation requirements at all times.
3. The product must only be used in countries for which it is approved or released by Solis and the grid operator.
4. Use Solis products only in accordance with the information provided in the enclosed documentation and with the locally applicable laws, regulations, standards and directives. Any other application may cause personal injury or property damage.
5. This document does not replace any regional, state, provincial, federal or national laws, regulations or standards that apply to the installation, electrical safety and use of the product. Solis assumes no responsibility for the compliance or non-compliance with such laws or codes in connection with the installation of the product.
6. The electrical installation must meet all the applicable regulations and standards.
7. The inverter must be installed according to the instructions stated in this manual.
8. The inverter must be installed according to the correct technical specifications.

2.4 Notice for Disposal

This product shall not be disposed of with household waste. They should be segregated and brought to an appropriate collection point to enable recycling and avoid potential impacts on the environment and human health. Local rules in waste management shall be respected .

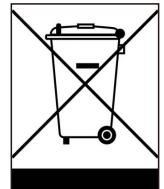

3.1 Front Panel Display

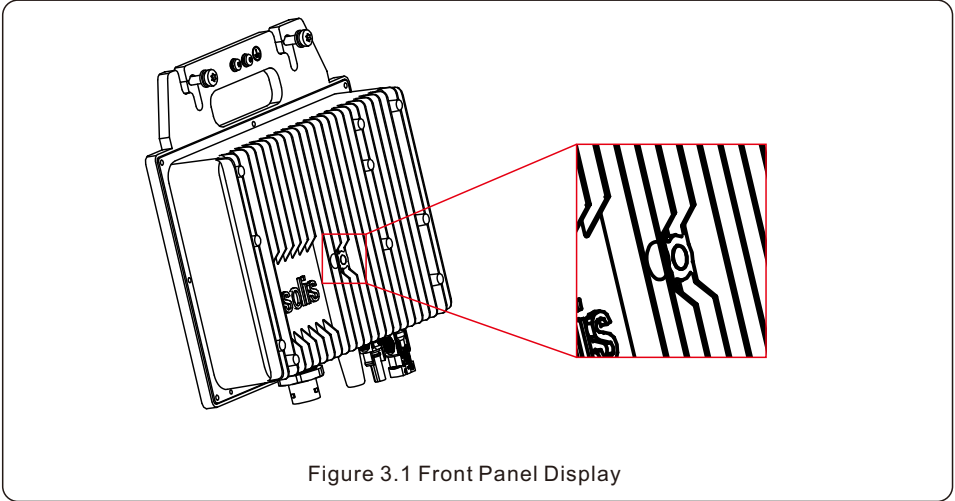

Figure 3.1 Front Panel Display

3.2 LED Status Indicator Lights

	Light	Status	Description
①	● POWER	ON	Fault condition is detected.
		FLASHING	Alarm condition is detected.
②	● OPERATION	ON	The inverter is operating properly.
		FLASHING	The inverter is initializing.

Table 3.1 Status Indicator Lights

4.1 System Diagram

The inverter integrates WIFI and Bluetooth communication modules, and is equipped with AC cables and plugs, so that the entire micro photovoltaic system can be built without additional equipment.

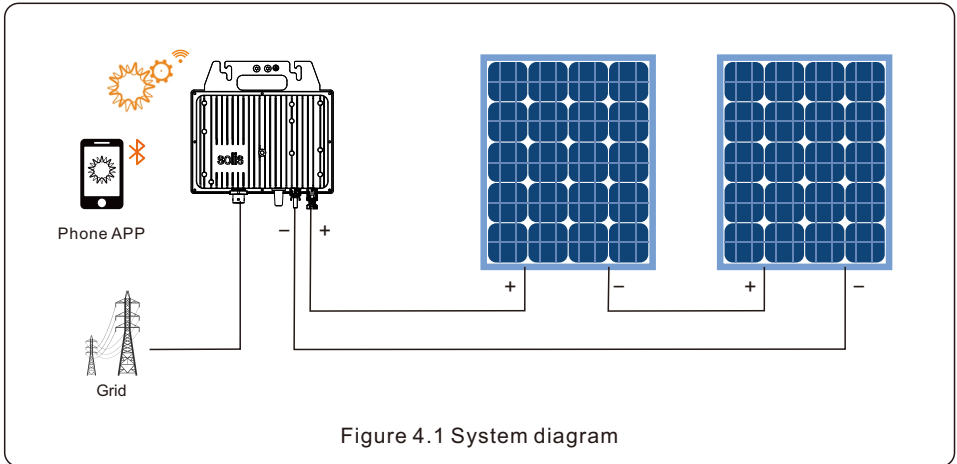

NOTE:

It is recommended to install a DC switch at the DC input side of the inverter, the recommended current rating of the switch shall be 25A.

4.2 Mounting the Inverter

The Ultra mini is designed to mount on the rack under PV modules.

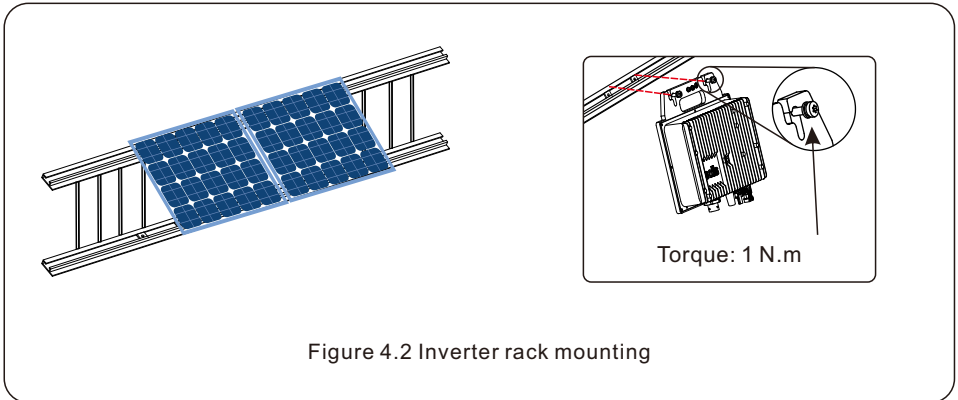

1. Evaluate the location of the Ultra mini with respect to the PV module junction box or any other obstructions.



WARNING:

Allow a minimum of 3/4 inches between the top of the roof and the bottom of the Ultra mini. We also recommend that you allow 1/2 inches between the back of the PV module and the top of the Ultra mini. Do not mount the Ultra mini in a location that allows exposure to direct sunlight.

2. If using grounding washers (e.g. WEEB) to ground the Ultra mini chassis to the PV module racking, choose a grounding washer that is approved for the racking manufacturer. Install a minimum of one grounding washer for the Ultra mini.

4.3 External ground connection

An external ground connection is provided at the upper side of inverter.

Prepare OT terminals: M6.

Use proper tooling to crimp the lug to the terminal.

Connect the OT terminal with grounding conductor to the upper side of inverter.

The torque is 2N.m.

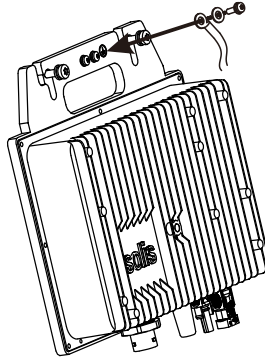

Figure 4.3 Connect the external grounding conductor

4.4 Electrical Connections

The inverter terminal connection symbols is shown in table 4.1.

PV+	Positive DC input terminal
PV-	Negative DC input terminal
WiFi	Wifi external antenna interface
GRID	Connecting terminal of the Grid

Table 4.1 Electrical connection symbols

4.4.1 Connect grid side of inverter

For all AC connections, 1.0- 6mm² cable is required. Please make sure the resistance of cable is lower than 1 ohm. If the cable is longer than 20m, it's recommended to use 6mm² cable.



There are "L", "N", "PE" symbols marked inside the connector, the Line wire of grid must be connected to "L" terminal, the Neutral wire of grid must be connected to "N" terminal and Earth wire must be connected to "PE".

Cable type	Cross section (mm ²)	
	Range	Recommended value
Industry generic AC cable	1.0~6.0	1.0

Table 4.2 Grid cable size



NOTE:

PE wire is required to be the same as L, N wire material and cross-sectional area.



Figure 4.4 AC Grid Terminal Connector Inside

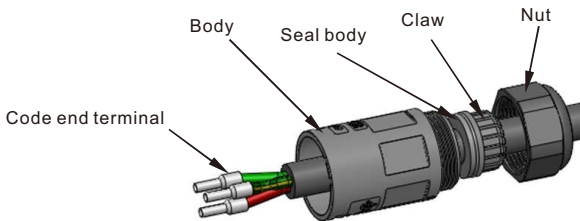

Figure 4.5 AC Grid Terminal Connector

The steps to assemble the AC grid terminal connectors are listed as follows:

1. Disassemble the AC connector. Strip the AC wires about 7mm.

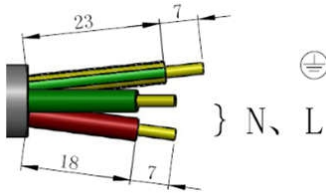

Figure 4.6 Stripped AC Wires

2. Fix the wires into the correct position. Torque 0.8N.m
Please try to pull out the wire to make sure the connection is well.

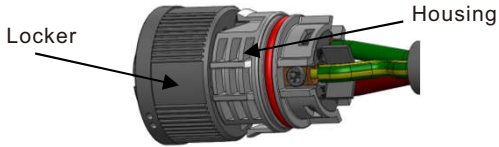

Figure 4.7 Connect Wires to the Terminal

3. Insert Seal and Clamp Finger into body ,then tighten the nut, torque 2.5+/-0.5N.m.



Figure 4.8 Tighten up the Cap on the Terminal

4. Mating plug and socket:

Push the locker onto the socket housing completely, then rotate the locker according to the direction instructed by the marks on the locker. (Warning: hold the body)

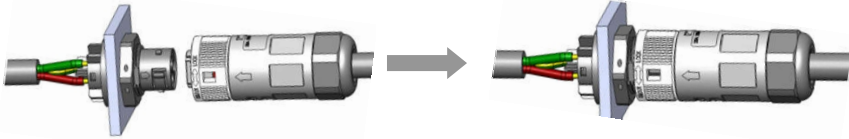

Figure 4.9 Connect the AC Connector to the Inverter



NOTE: Connection for Split phase grid.

When connect to 208/220/240V split phase, please connect L1 to “L” terminal, L2 to “N” terminal. Also connect earth to ground terminal.



NOTE:

In final installation, if an AC breaker is used, the breaker should be in accordance with IEC60947-1 and IEC60947-2.

4.4.2 Connect PV side of inverter

The electrical connection of the inverter PV side must follow the steps listed:



Before connecting inverter, please make sure the PV array open circuit voltage is within the limit of the inverter.



NOTE:

Before connection, please make sure the polarity of the output voltage of PV array matches the “DC+” and “DC-” symbols.



WARNING:

Please don't connect PV array positive or negative pole to the ground, it could cause serious damages to the inverter.

Please complete the assembling of the DC cable according to below procedures:

Step 1: Choose a proper DC cable and strip about $7 \pm 0.5\text{mm}$, refer to the following table for specifications.

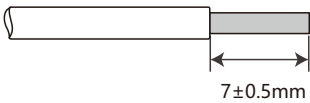

Cable type	Cross section(mm ²)	
	Range	Recommended value
Industry generic PV cable (model:PV1-F)	4.0~6.0 (12~10AWG)	4.0(12AWG)

Figure 4.10 Strip

Step 2: take out the DC connector from the accessory bag, rotate the nut to remove it and take out the waterproof rubber ring.

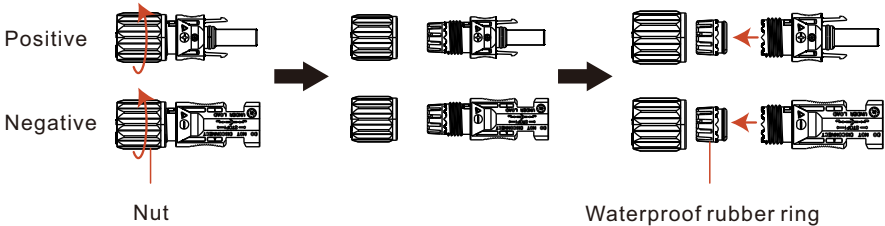

Figure 4.11 Remove the cover of the terminal connector

Step 3: Pass the stripped DC cable through the nut and waterproof rubber ring.

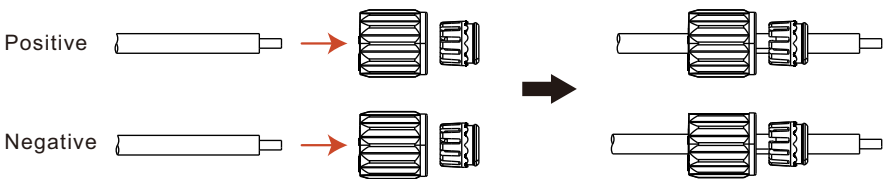
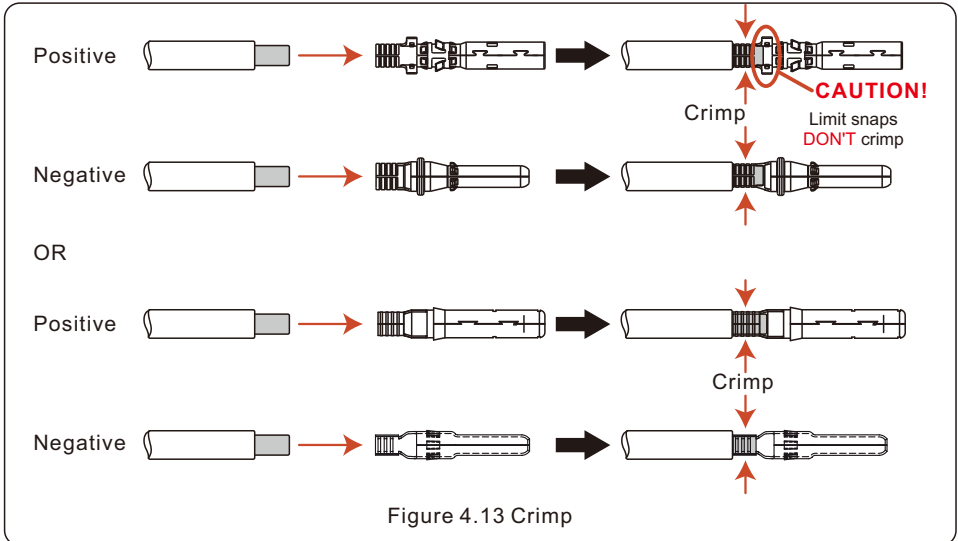
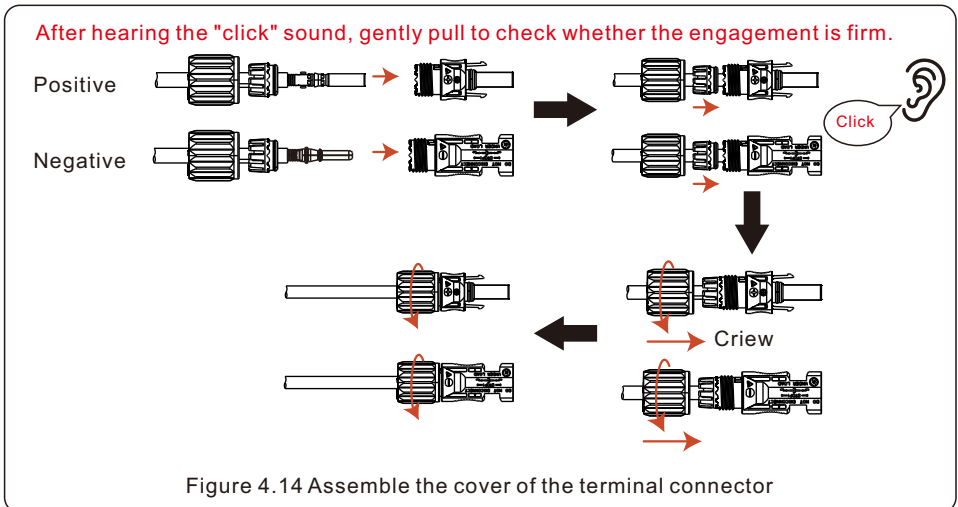

Figure 4.12 Pass the cable trough

Step 4: Connect the conductor part of the DC cable to the metal DC terminal and press it with the DC terminal crimping tool.



Step 5: Insert the crimped DC cable firmly into the DC terminal, then insert the waterproof rubber ring into the DC terminal and tighten the nut.



Step 6: Use a multimeter to measure the DC input voltage and verify the polarity of the DC input cable.

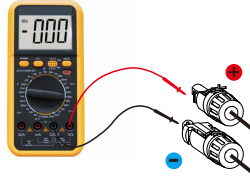

Figure 4.15 Multi-meter measurement

Step 7: Connect the assembled DC terminal to the inverter as shown in the figure, and a slight "click" will be heard, proving that the connection is correct.

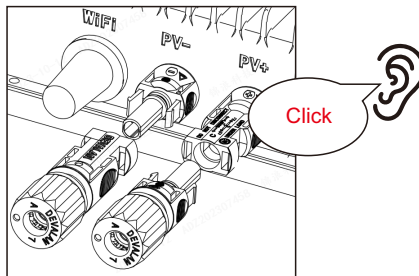

Figure 4.16 Connect to the inverter



CAUTION:

If DC inputs are accidentally reversely connected or inverter is faulty or not working properly, it is NOT allowed to pull out the DC terminal directly. Otherwise it may cause DC arc and damage the inverter or even lead to a fire disaster.

The correct actions are:

*In the Setting page of SolisApp, make a Power OFF operation.

And make sure the AC output current of the inverter is 0.

*Disconnect the inverter AC output connection with the grid.

*Make sure the DC input current of the inverter is 0, then disconnect the inverter DC input connection.

*Please note that dangerous voltages may exist between the PV string terminals when the PV modules are exposed to sunlight. Do NOT touch the terminal without an insulation gloves to prevent the electric shock and life danger. Please note that any damages due to wrong operations are not covered in the device warranty.

4.5 Max. over current protection device (OCPD)

To protect the inverter's AC grid connection conductors, Solis recommends installing breakers that will protect against overcurrent. The following table defines OCPD ratings for the inverter.

Inverter	Rated output voltage(V)	Rated output current (A)	Current for protection device (A)
S6-GR1P0.8K-UM	230	3.5	6

Table 4.3 Rating of grid OCPD

5.1 Preparation

- Ensure all the devices are accessible for operation, maintenance and service.
- Check and confirm that the inverter is firmly installed.
- Space for ventilation is sufficient for one inverter or multiple inverters.
- Nothing is left on the top of the inverter.
- Inverter and accessories are correctly connected.
- Cables are routed in safe place or protected against mechanical damage.
- Warning signs and labels are suitably affixed and durable.
- An Android or IOS mobile phone with Bluetooth function is available.
- Measure DC voltage of PV strings and ensure the polarity is correct.
- Measure AC voltage and frequency and ensure they are within local standard.

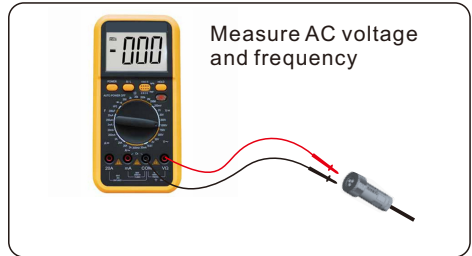
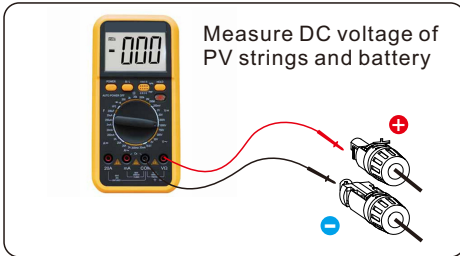

5.2 APP Download

Users need to download the APP before installing it for the first time.

There are three ways to download and install the latest APP:

1. You can visit www.soliscloud.com to download the latest version APP.
2. You can search "Soliscloud" in Google Play or App Store.
3. You can scan this QR code below to download "Soliscloud".



5.3 Log in the APP via bluetooth

Step 1: **Register and log in to your account.**

Make Sure Your Bluetooth, WIFI, and GPRS functions are turned on. Register account, click on the upper right corner Register, select the Organization/Owner , fill in the relevant information to Register.

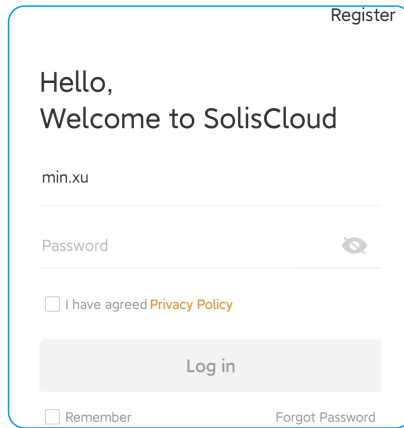

The screenshot shows the 'Register' screen of the SolisCloud app. At the top right, the word 'Register' is displayed. The main heading reads 'Hello, Welcome to SolisCloud'. Below this, there is a text input field containing 'min.xu'. Underneath is a 'Password' field with a toggle icon on the right. A checkbox is present with the text 'I have agreed Privacy Policy'. A large grey button labeled 'Log in' is centered below the form. At the bottom left, there is a 'Remember' checkbox, and at the bottom right, there is a 'Forgot Password' link.

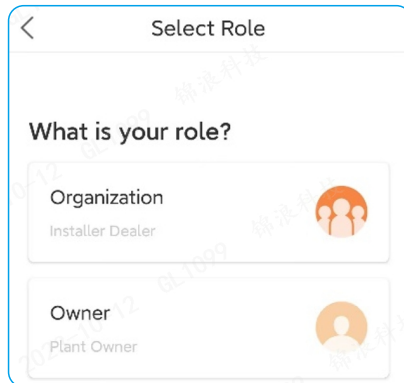

The screenshot shows the 'Select Role' screen in the app. A back arrow is in the top left corner, and the title 'Select Role' is at the top center. The main heading is 'What is your role?'. There are two selectable options, each in a rounded rectangular box. The first option is 'Organization' with the subtext 'Installer Dealer' and an icon of three people. The second option is 'Owner' with the subtext 'Plant Owner' and an icon of a single person.

Step 2: Local Operation.

After the completion of registration, log into the soliscloud.

Go to the Overview page, and make a bluetooth connection.

Click "Service" - "Local Operation" - "Connect With Bluetooth"

Select the corresponding bluetooth number of the inverter, after the successful bluetooth connection, you can inspect the inverter information. If you want to change the setting of inverter, see the "S6-GR1P0.8K-UM SolisCloud Operation Setup" at <https://www.solisinverters.com/de> for help.

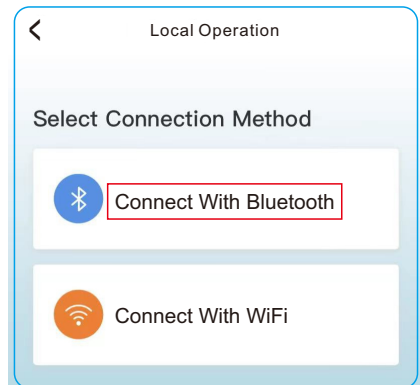
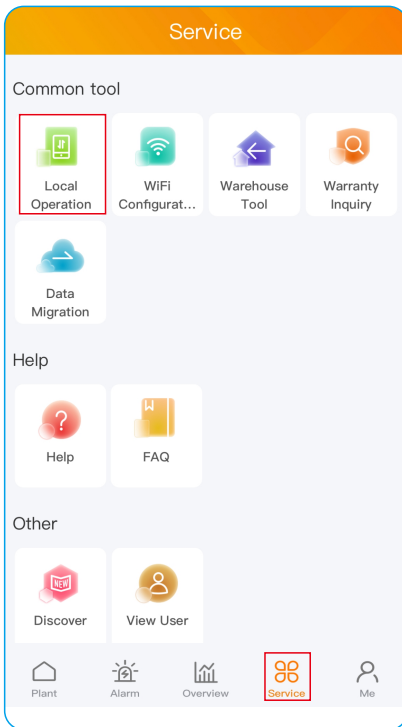

Step 3: WiFi Configuration (Optional)

If remote monitoring function is needed, the built in WiFi can be configured to enable the data uploading on Soliscloud remote platform.

Go to the Overview page:

Click "Service" - "WiFi Configuration"

See the "Network Configuration User Manual" at <https://www.solisinverters.com/de> for help.

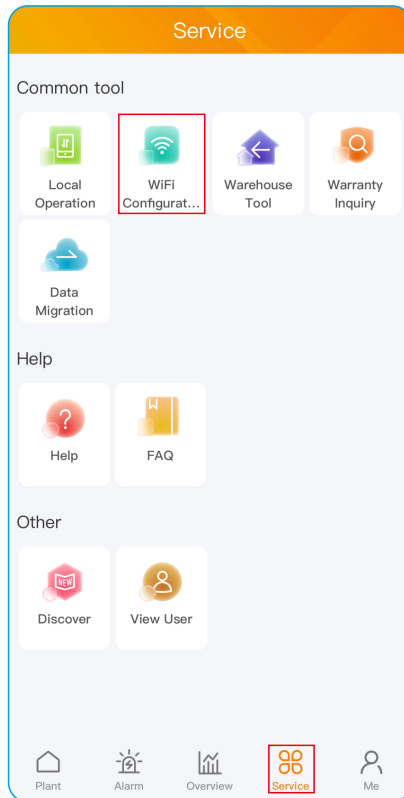

Step 4: Perform the setting configuration for Grid Code Setting, etc.

5.4 Stop the Inverter

To stop the inverter, it is mandatory that the steps below are followed in the exact order outlined.

1. Select "Power OFF" in the APP.
2. Turn off the AC connection between Solis inverter and Grid.
3. Wait approximately 30 seconds (during this time, the AC side capacitors are dissipating energy). If the inverter has DC voltage above the start-up threshold, the red POWER LED will be lit. Turn off the connection between Solis inverter and PV module.
4. Confirm all LED's switch OFF.



CAUTION:

Although the connection between the Solis inverter and the PV module has been closed and all the LED's are OFF, operators must wait five (5) minutes after the DC power source has been disconnected before opening the inverter cabinet. DC side capacitors can take up to five (5) minutes to dissipate all stored energy.

The APP interface contains 4 sections:

1. Home
2. Info
3. Alarm
4. Settings

6.1 Home Page

The home page contains the power and energy data of the inverter.
The PV data and AC data are also available under this section.

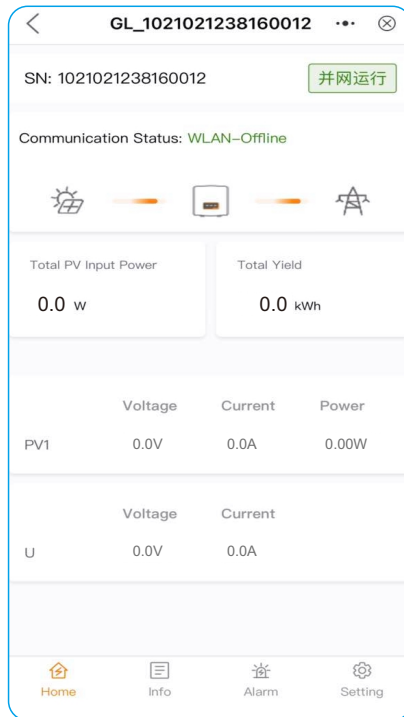

6.2 Info Page

Info page displays the general information of the inverter such as inverter serial number, firmware version, grid code, etc.

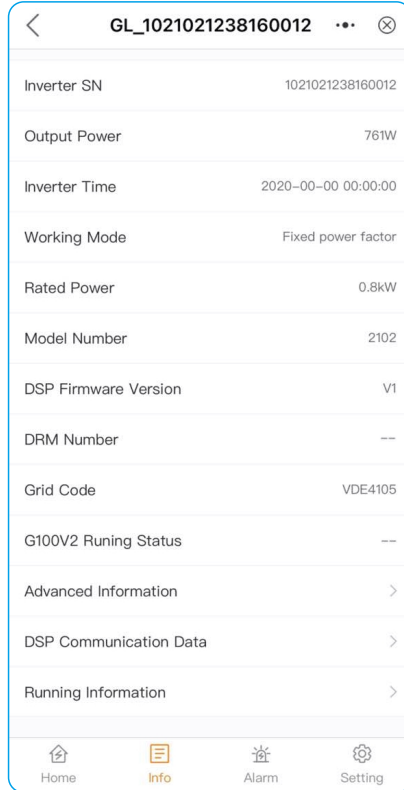

6.3 Alarm Page

Alarm page contains the alarm code of the inverter and its corresponding troubleshooting methods.

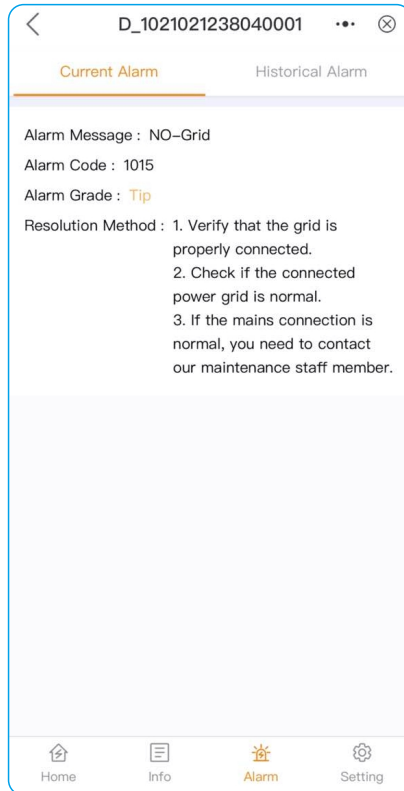

6.4 Setting Page

Setting page contains all the setting options of the inverter.

Functions	Setting Path
Switch on/off the inverter	Settings -> "Power ON" & "Power OFF"
Change inverter time setting	Settings -> Inverter Setting-> Inverter Parameter Setting -> Inverter Time Setting
Change inverter output power percentage or power factor	Settings -> Inverter Setting-> Inverter Power Setting
Set grid code and protection parameters	Settings -> Grid Parameter Setting -> Grid Code Setting
Set grid code related working modes	Settings -> Inverter Work Mode Setting -> Work Mode

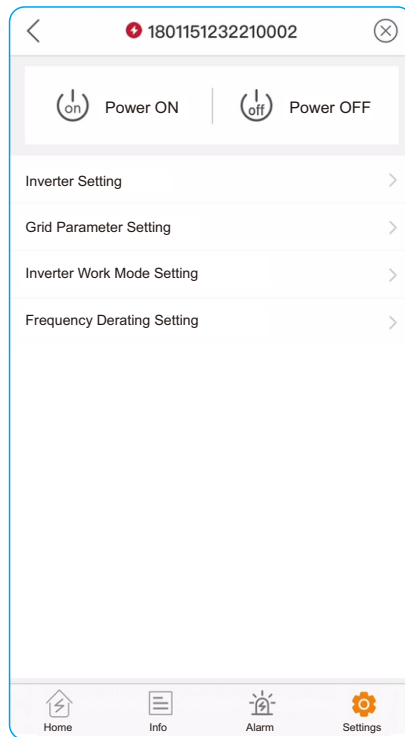

The inverter does not require any regular maintenance. However, cleaning the dust on heat-sink will help the inverter to dissipate the heat and increase its life time. The dust can be removed with a soft brush.



CAUTION:

Do not touch the inverter's surface when it is operating. Some parts of the inverter may be hot and cause burns. Turn off the inverter and wait for a cool-down period before any maintenance or cleaning operation.

The LED status indicator lights can be cleaned with cloth if they are too dirty to be read.



NOTE:

Never use any solvents, abrasives or corrosive materials to clean the inverter.

8. Specifications

Model	S6-GR1P0.8K-UM
Max. DC input voltage (Volts)	500
Rated DC voltage (Volts)	60
Startup voltage (Volts)	40
MPPT voltage range (Volts)	30-500
Max. input current (Amps)	16
Max short circuit input current (Amps)	25
MPPT number/Max input strings number	1/1
Rated output power (Watts)	800
Max. output power (Watts)	800
Max. apparent output power (VA)	800
Rated grid voltage (Volts)	1/N/PE, 230
Rated output current (Amps)	3.5
Max. output current (Amps)	3.5
Power Factor (at rated output power)	> 0.99 (0.8 leading - 0.8 lagging)
THDi (at rated output power)	<3%
Rated grid frequency (Hertz)	50
Operating frequency range (Hertz)	45-55
Max. efficiency	96.6%
MPPT efficiency	99.5%
Dimensions (W*H*D)	265*225*64 (mm)
Weight	2.9kg
Protection class	I
Overvoltage class	III
Topology	Transformerless
Self consumption (night)	< 1 W
Operating ambient temperature range	-25°C...+60°C
Relative humidity	0~100%
Ingress protection	IP65
Cooling concept	Natural convection
Max. operation altitude	2000m
Grid connection standard	VDE-AR-N 4105: 2018, TOR typeA
Safety/EMC standard	IEC/EN 62109-1/-2, IEC/EN 61000-6-1/-2/-3/-4
DC connection	MC4 connector
AC connection	Quick connection plug
Display	LED+APP
Communication connections	WiFi+Bluetooth
Warranty Terms	10 Years (Extend to 20 Years)

Ginlong Technologies Co., Ltd.

No. 57 Jintong Road, Binhai Industrial Park, Xiangshan, Ningbo,
Zhejiang, 315712, P.R.China.

Tel: +86 (0)574 6578 1806

Fax: +86 (0)574 6578 1606

Email: info@ginlong.com

Web: www.ginlong.com

Please adhere to the actual products in case of any discrepancies in this user manual.

If you encounter any problem on the inverter, please find out the inverter S/N
and contact us, we will try to respond to your question ASAP.



Type Approved
Safety
Regular Production
Surveillance
www.tuv.com
ID: 200900090