



Solis Three Phase Inverter

(185-255)K **Installation and Operation Manual**

For U.S.

Ver 1.0

Manufacturer: Ginlong Technologies Co.,Ltd., Ningbo, Zhejiang, P.R.China

US Office: 565 Metro Pl. S. Suite 3214, Dublin OH 43017, USA

Toll-free: 866.438.8408 | Email: sales@ginlong.com | ussales@ginlong.com

Web: www.ginlong.com | www.ginlong-usa.com

Please adhere to the actual products in case of any discrepancies in this user manual.

Please record the serial number of your inverter and quote this when you contact us.

Ginlong Technologies Co., Ltd.

Important notes

- Product specifications are subject to change without notice. Every attempt has been made to make this document complete, accurate and up-to-date. Individuals reviewing this document and installers or service personnel are cautioned, however, that Ginlong reserves the right to make changes without notice and shall not be responsible for any damages, including indirect, incidental or consequential damages caused by reliance on the material presented including, but not limited to, omissions, typographical errors, arithmetical errors or listing errors in the material provided in this document.
- Ginlong accepts no liability for customers' failure to comply with the instructions for correct installation and will not be held responsible for upstream or downstream systems Ginlong equipment has supplied.
- The customer is fully liable for any modifications made to the system; therefore, any hardware or software modification, manipulation, or alteration not expressly approved by the manufacturer shall result in the immediate cancellation of the warranty.
- Given the countless possible system configurations and installation environments, it is essential to verify adherence to the following:
 - There is sufficient space suitable for housing the equipment.
 - Airborne noise produced depending on the environment.
 - Potential flammability hazards.
- Ginlong will not be held liable for defects or malfunctions arising from:
 - Improper use of the equipment.
 - Deterioration resulting from transportation or particular environmental conditions.
 - Performing maintenance incorrectly or not at all.
 - Tampering or unsafe repairs.
 - Use or installation by unqualified persons.
- This product contains lethal voltages and should be installed by qualified electrical or service personnel having experience with lethal voltages.

1. Introduction	4
1.1 Product Description	4
1.2 Unpacking and storage	5
1.2.1 Storage	6
2. Safety instructions	7
2.1 Safety symbols	7
2.2 General safety instructions	7
2.3 Notice for use	8
2.4 Protection Circuitry and Controls	8
3. Installation	9
3.1 Environmental considerations	9
3.1.1 Select a location for the inverter	9
3.1.2 Other environmental considerations	10
3.2 Product handling	11
3.3 Mounting the Inverter	12
3.3.1 Wall mounting	13
3.4 Electrical Connections	14
3.4.1 Grounding	15
3.4.2 Connect PV side of inverter	17
3.4.3 Connect grid side of inverter	19
4. Communication & Monitoring	23
4.1 RS485 and PLC communication connection	23
5. Commissioning	25
5.1 Selecting the appropriate grid standard	25
5.1.1 Verifying grid standard for country of installation	25
5.2 Changing the grid standard	25
5.2.1 Procedure to set the grid standard	25
5.3 Setting a custom grid standard	26
5.4 Preliminary checks	27
5.4.1 DC Connections	27
5.4.2 AC Connections	27
5.4.3 DC configuration	27
5.4.4 AC configuration	28
6. Start and Shutdown	29
6.1 Start-up procedure	29
6.2 Shutdown procedure	29
7. Normal operation	30
7.1 Main Menu	30
7.2 Information	30
7.2.1 Lock screen	32

7.3 Settings	33
7.3.1 Set Time	33
7.3.2 Set Address	33
7.4 Advanced Info - Technicians Only	34
7.4.1 Alarm Message	34
7.4.2 Running Message	34
7.4.3 Version	35
7.4.4 Daily Energy	35
7.4.5 Monthly Energy	35
7.4.6 Yearly Energy	36
7.4.7 Daily Records	36
7.4.8 Communication Data	36
7.4.9 Warning Message	36
7.5 Advanced Settings - Technicians Only	37
7.5.1 Selecting Standard	37
7.5.2 Grid ON/OFF	39
7.5.3 Clear Energy	40
7.5.4 Reset Password	40
7.5.5 Power control	40
7.5.6 Calibrate Energy	41
7.5.7 Special Settings	41
7.5.8 STD Mode settings	41
7.5.9 Restore Settings	54
7.5.10 HMI Update	54
7.5.11 Restart HMI	54
7.5.12 Fan Test	55
7.5.13 DSP Update	55
7.5.14 Compensation Set	55
7.5.15 I/V Curve	56
8. Maintenance	57
8.1 Anti-PID Function	57
8.2 Fan Maintenance	58
9. Troubleshooting	59
10. Specifications	62
11. Appendices	64

1. Introduction

1.1 Product Description

Solis Three phase Transformerless Grid Support Utility Interactive PV Inverters convert DC power from the photovoltaic(PV) array into alternating current(AC) power that can satisfy local loads as well as feeding into the power distribution grid.

This manual covers the three phase inverter model listed below:

Solis-185K-EHV-5G-US, Solis-255K-EHV-5G-US

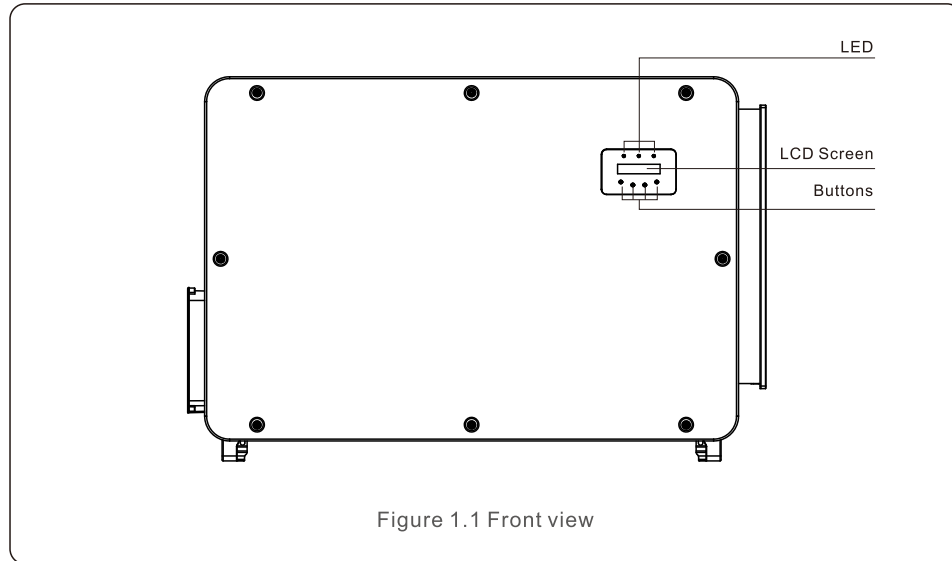

Figure 1.1 Front view

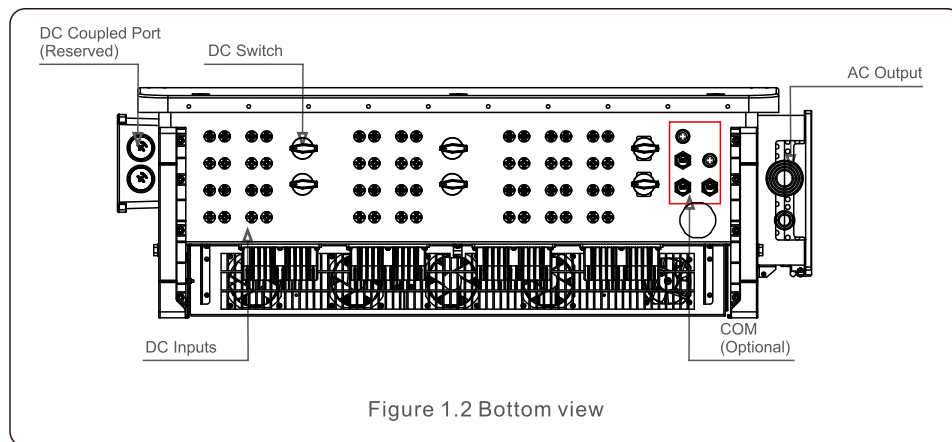

Figure 1.2 Bottom view

1. Introduction

1.2 Unpacking and storage

The inverter ships with all accessories in one carton.

When unpacking, please verify all the parts listed below are included:

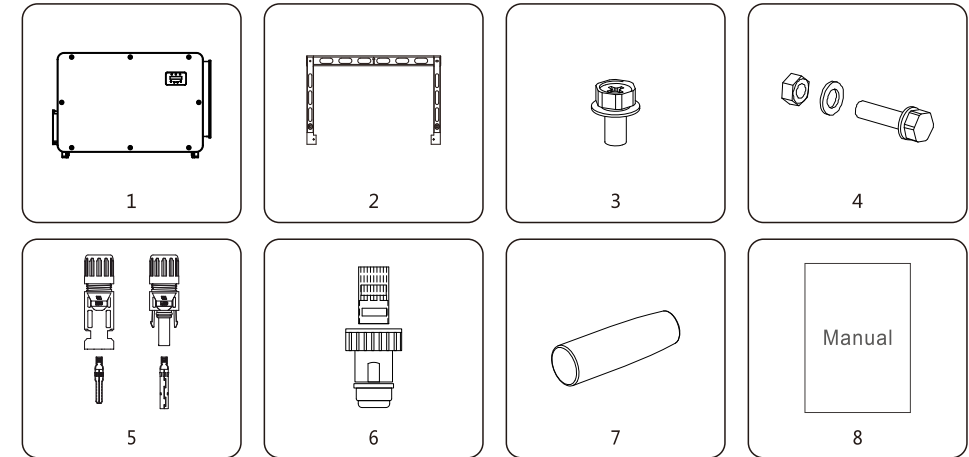

Part #	Description	Number	Remarks
1	Inverter	1	
2	Mounting Bracket	1	
3	Fastening screw	2	Hexagon bolt M6*12
4	Fastening screw, hex nut and flat gasket	4	Hexagon bolt M10*40
5	DC connector	28	
6	RJ45 connector	3	
7	Handle	4	
8	User manual	1	

Inverter packing list

1. Introduction

1.2.1 Storage

If the inverter is not installed immediately, storage instructions and environmental conditions are below:

- Use the original box to repackage the inverter, seal with adhesive tape with the desiccant inside the box.
- Store the inverter in a clean and dry place, free of dust and dirt. The storage temperature must be between 40~176°F and humidity should be between 0 to 100%, non-condensing.
- Do not stack more than two (2) inverters high on a single pallet. Do not stack more than 2 pallets high.
- Keep the box(es) away from corrosive materials to avoid damage to the inverter enclosure.
- Inspect the packaging regularly. If packing is damaged (wet, pest damages, etc.), repackage the inverter immediately.
- Store inverters on a flat, hard surface -- not inclined or upside down.
- After 100 days of storage, the inverter and carton must be inspected for physical damage before installing. If stored for more than 1 year, the inverter needs to be fully examined and tested by qualified service or electrical personnel before using.
- Restarting after a long period of non-use requires the equipment be inspected and, in some cases, the removal of oxidation and dust that has settled inside the equipment will be required.



Figure 1.3

2. Safety Instructions

SAVE THESE INSTRUCTIONS – This manual contains important instructions for Models Solis-185K-EHV-5G-US and Solis-255K-EHV-5G-US that shall be followed during installation and maintenance of the inverter.

2.1 Safety symbols

Safety symbols used in this manual, which highlight potential safety risks and important safety information, are listed below:



WARNING

Symbol indicates important safety instructions, which if not correctly followed, could result in serious injury or death.



NOTE

Symbol indicates important safety instructions, which if not correctly followed, could result in damage to or the destruction of the inverter.



CAUTION, RISK OF ELECTRIC SHOCK

Symbol indicates important safety instructions, which if not correctly followed, could result in electric shock



CAUTION, HOT SURFACE

Symbol indicates safety instructions, which if not correctly followed, could result in burns.

2.2 General safety instructions



WARNING

Do not connect PV array positive (+) or negative (-) to ground – doing so could cause serious damage to the inverter.



WARNING

Electrical installations must be done in accordance with local and national electrical safety standards.



WARNING

To reduce the risk of fire, branch circuit over-current protective devices (OCPD) are required for circuits connected to the Inverter.



CAUTION

The PV array (solar panels) supplies a DC voltage when exposed to light.

2. Safety Instructions



CAUTION

Risk of electric shock from energy stored in the inverter's capacitors. Do not remove cover until 20 minutes after disconnecting all sources of supply have passed, and this can only be done by a service technician. The warranty may be voided if any unauthorized removal of cover occurs.



CAUTION

The inverter's surface temperature can reach up to 167°F . To avoid risk of burns, do not touch the surface when the inverter is operating. Inverter must be installed out of the reach of children.



WARNING

The inverter can only accept a PV array as a DC input. Using any other type of DC source could damage the inverter.

2.3 Notice for use

The inverter has been constructed according to applicable safety and technical guidelines. Use the inverter in installations that meet the following requirements ONLY:

- 1). The inverter must be permanently installed.
- 2). The electrical installation must meet all the applicable regulations and standards.
- 3). The inverter must be installed according to the instructions stated in this manual.
- 4). The system design must meet inverter specifications.

To start-up the inverter, the Grid Supply Main Switch (AC) must be turned on, BEFORE the DC Switch is turned on. To stop the inverter, the Grid Supply Main Switch (AC) must be turned off before the DC Switch is turned off.

2.4 Protection Circuitry and Controls

To meet relevant codes and standards, the Solis three phase inverter line is equipped with protective circuitry and controls.

Anti-Islanding Protection:

Islanding is a condition where the inverter continues to produce power even when the grid is not present. Circuitry, along with firmware, has been designed to determine if the grid is present by adjusting the output frequency of the inverter. In the case of a 60Hz resonant system where the inverter is partially isolated from the grid, the inverter programming can detect if there is a resonant condition or if the grid is actually present. It can also differentiate between inverters operating in parallel and the grid.

3. Installation

3.1 Environmental considerations

3.1.1 Select a location for the inverter

When selecting a location for the inverter, consider the following:



WARNING: Risk of fire

Despite careful construction, electrical devices can cause fires.

- Do not install the inverter in areas containing highly flammable materials or gases.
- Do not install the inverter in potentially explosive atmospheres.

- The temperature of the inverter heat-sink can reach 167°F.
- The inverter is designed to work in an ambient temperature range between -25~140°F.
- If multiple inverters are installed on site, a minimum clearance of 27.5 in should be kept between each inverter and all other mounted equipment. The bottom of the inverter should be at least 27.5 in above of the ground or floor (see Figure 3.1).
- The LED status indicator lights and the LCD located on the inverter's front panel should not be blocked.
- Adequate ventilation must be present if the inverter is to be installed in a confined space.

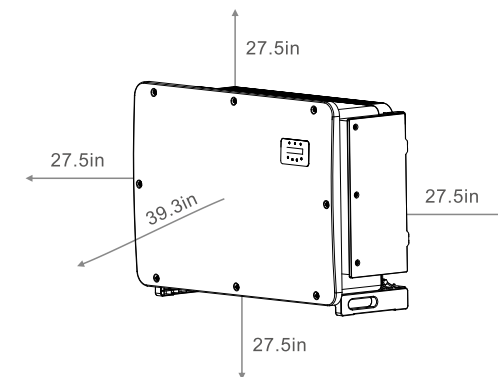

Figure 3.1 Distances required between inverters



NOTE

Nothing should be stored on or placed against the inverter.

3. Installation

3.1.1.1 Examples of correct and incorrect installations

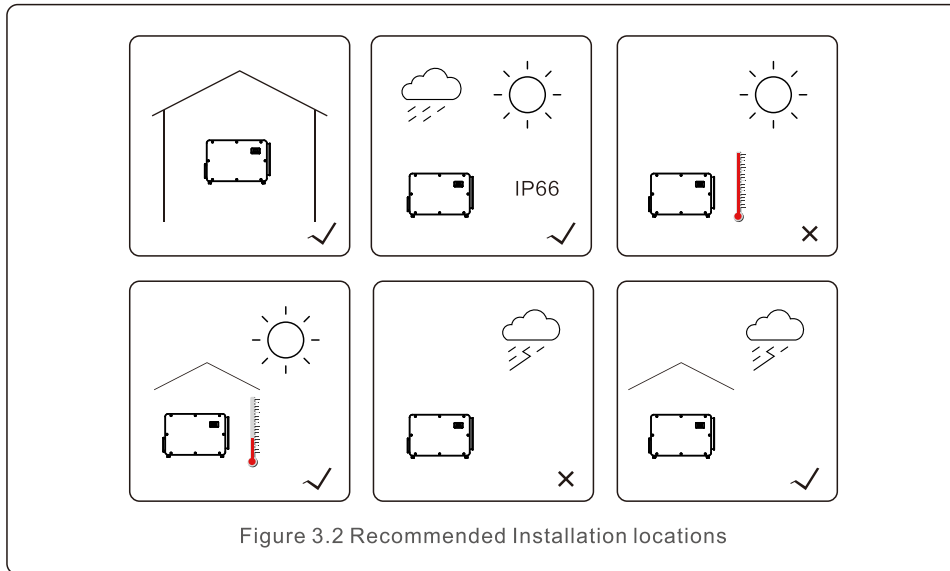

Figure 3.2 Recommended Installation locations

3.1.2 Other environmental considerations

3.1.2.1 Consult technical data

Consult the specifications section (section 10) for additional environmental conditions (protection rating, temperature, humidity, altitude, etc.).

3.1.2.2 Vertical wall installation

This model of Solis inverter should be mounted vertically.

3.1.2.3 Avoiding direct sunlight

Installation of the inverter in a location exposed to direct sunlight should be avoided.

Direct exposure to sunlight could cause:

- Power output limitation (with a resulting decreased energy production by the system).
- Premature wear of the electrical/electromechanical components.
- Premature wear of the mechanical components (gaskets) and user interface.

3. Installation

3.1.2.4 Air circulation

Do not install in small, closed rooms where air cannot freely circulate. To prevent overheating, always ensure that the air flow around the inverter is not blocked.

3.1.2.5 Flammable substances

Do not install near flammable substances. Maintain a minimum distance of three (3) meters (10 feet) from such substances.

3.1.2.6 Living area

Do not install in a living area where the prolonged presence of people or animals is expected. Depending on where the inverter is installed (for example: the type of surface around the inverter, the general properties of the room, etc.) and the quality of the electricity supply, the sound level from the inverter can be quite high.

3.2 Product handling

Please review the instruction below for handling the inverter:

1. The red circles below denote cutouts on the product package.

Push in the cutouts to form handles for moving the inverter around 249lb (see Figure 3.3).

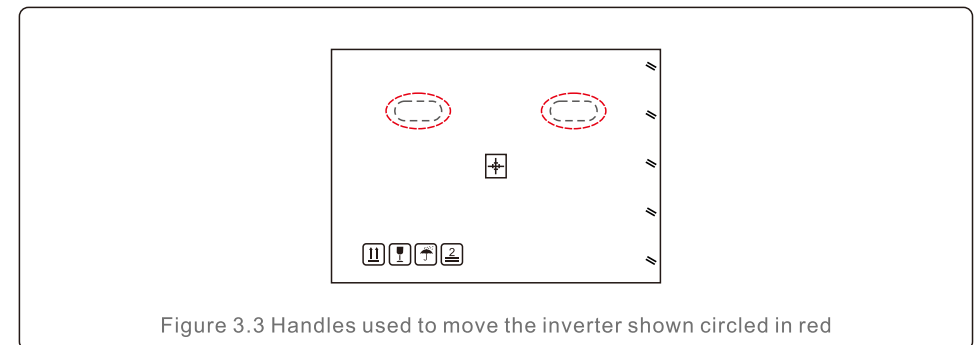

Figure 3.3 Handles used to move the inverter shown circled in red

2. Two people are required to remove the inverter from the shipping box. Use the handles integrated into the heat sink to remove the inverter from the carton (see Figure 3.4).

3. Installation

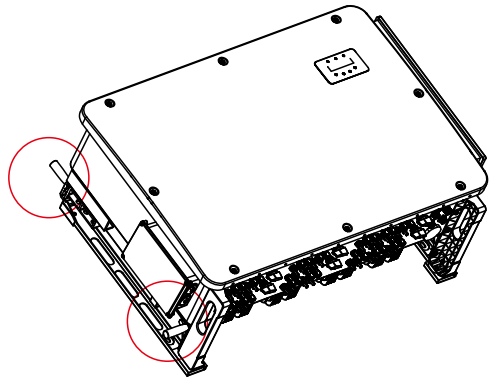

Figure 3.4 Inverter handles



WARNING

Due to the weight of the inverter, contusions or bone fractures could occur when incorrectly lifting and mounting the inverter. When mounting the inverter, take the weight of the inverter into consideration. Use a suitable lifting technique when mounting. When installers are carrying the inverter, please use 4 handles to secure safety. Lifting force of each handle shall not exceed 1.5 times of the inverter weight.

3.3 Mounting the Inverter

The inverter can be mounted to the wall or metal array racking. The mounting holes should be consistent with the size of the bracket or the dimensions shown in Figure 3.5.

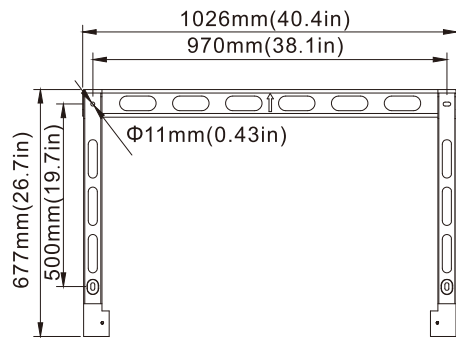

Figure 3.5 Inverter wall mounting

3. Installation

3.3.1 Wall mounting

Refer to figure 3.7 Inverter shall be mounted vertically.

The steps to mount the inverter are listed below.

1. Refer to Figure 3.7, drill holes for mounting screws based on the hole diameter of bracket using a precision drill keeping the drill perpendicular to the wall. Max depth is 3.5 in.
2. Make sure the bracket is horizontal. And the mounting holes are marked correctly. Drill the holes into wall at your marks.
3. Use the suitable mounting screws to attach the bracket on the wall.
4. Lift the inverter and hang it on the bracket, and then slide down to make sure they match perfectly.

Inverter hook

Torque:22.1-25.8 ft.lbs

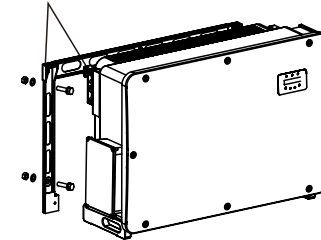

Figure 3.6 Install the inverter

5. Use screws in the packaging to fix the inverter to the mount bracket.

Torque:1.5-2.2 ft.lbs

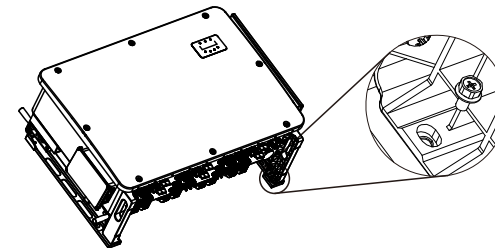

Figure 3.7 Fix the inverter

3. Installation

3.4 Electrical Connections

Inverter design uses PV style quick-connect terminal. The top cover needn't be opened during DC electrical connection. The labels located the bottom of the inverter are described below in table 3.1. All electrical connections are suitable for local or national standard.

Parts	Connection	Cable size	Torque
DC terminal	PV strings	12-10 AWG	NA
Ground terminal	AC ground	3-1 AWG	7.4-8.9 ft.lbs
Grid terminal	Grid	2-4/0 AWG	7.4-14.6 ft.lbs
RS-485 terminal	Communication cable	22-12 AWG	0.44 ft.lbs
RJ45 terminal	Communication cable	Network cable	NA
COM terminal	Wi-Fi/Cellular stick	NA	NA
DC surge protection device	NA	NA	NA

Table 3.1 Electrical connection symbols

The electrical connection of the inverter must follow the steps listed below:

1. Switch the Grid Supply Main Switch (AC) OFF.
2. Switch the DC Isolator OFF.
3. Connect the inverter to the grid.
4. Assemble PV connector and connect to the Inverter.

3. Installation

3.4.1 Grounding

To effectively protect the inverter, two grounding methods must be performed.

Connect the AC grounding cable (Please refer to section 3.4.3)

Connect the external grounding terminal.

To connect the grounding terminal on the heat sink, please follow the steps below:

- 1) Prepare the grounding cable: recommend to use the outdoor copper-core cable. The grounding wire should be at least half size of the hot wires.
- 2) Prepare OT terminals: M10.



Important:

For multiple inverters in parallel, all inverters should be connected to the same ground point to eliminate the possibility of a voltage potential existing between inverter grounds.

- 3) Strip the ground cable insulation to a suitable length.

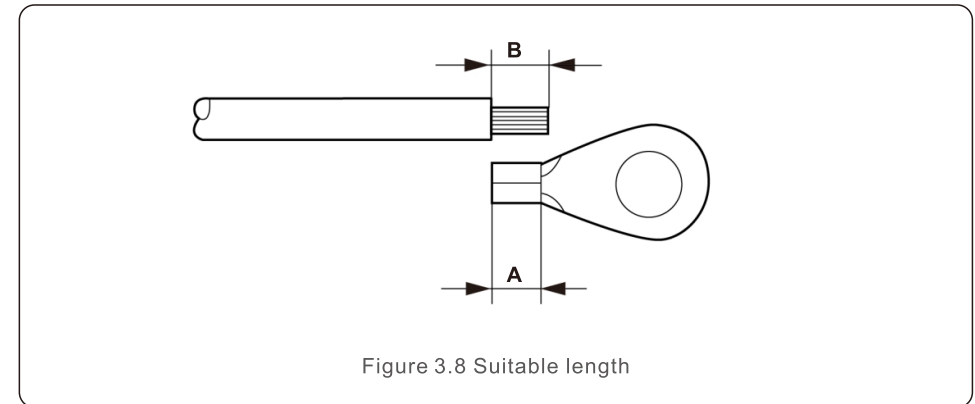

Figure 3.8 Suitable length



Important:

B (insulation stripping length) is 2mm~3mm longer than A (OT cable terminal crimping area).

3. Installation

4) Insert the stripped wire into the OT terminal crimping area and use the hydraulic clamp to crimp the terminal to the wire.

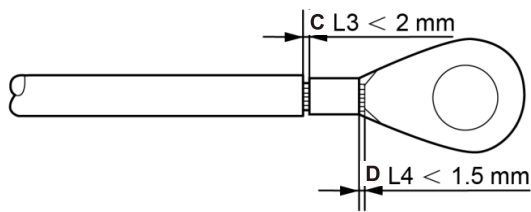

Figure 3.9 Strip wire



Important:

After crimping the terminal to the wire, inspect the connection to ensure the terminal is solidly crimped to the wire.

5) Remove the screw from the heat sink ground point.

6) Connect the grounding cable to the grounding point on the heat sink, and tighten the grounding screw, Torque is 7.4-8.9 lbs.

Grounding Screw

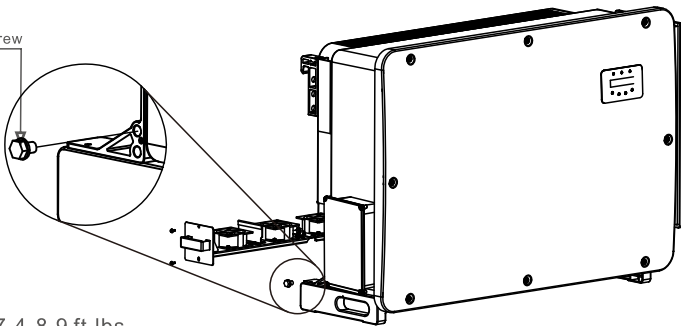

Torque : 7.4-8.9 ft.lbs

Figure 3.10 Fixed cable



Important:

For improving anti-corrosion performance, after ground cable installed, apply silicone or paint.

3. Installation

3.4.2 Connect PV side of inverter



WARNING

Before connecting the inverter, make sure the PV array open circuit voltage is within the limit of the inverter. Otherwise, the inverter could be damaged.



WARNING

DO NOT connect the PV array positive or PV array negative cable to ground. This can cause serious damage to the inverter!



WARNING

MAKE SURE the polarity of the PV array output conductors matches the DC- and DC+ terminal labels before connecting these conductors to the terminals of the inverter.



Important:

The inverter has a DC fuseless design with internal overcurrent protection. It is not needed to install any external DC string fuses or DC circuit breakers. If customers want to have redundant protection, they can choose to install external DC overcurrent protection devices with 1.5~2.4 times of the string I_{mp} . External DC overcurrent protection devices shall comply with IEC/EN 60269-6.

Please see table 3.1 for acceptable wire size for DC connections. Wire must be copper only. The steps to assemble the DC connectors are listed as follows:

1. Strip off the DC wire for about 7mm, Disassemble the connector cap nut.
2. Insert the wire into the connector cap nut and contact pin.

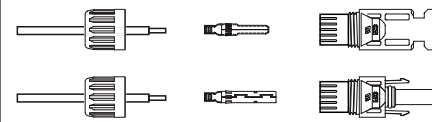

Figure 3.11 Disassemble the Connector Cap nut

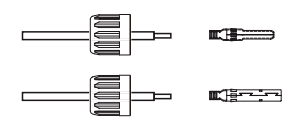

Figure 3.12 Insert the Wire into the Connector Cap nut and contact pin

3. Crimp the contact pin to the wire using a proper wire crimper.
4. Insert metal connector into top of connector, and tighten nut with torque 2.2-3 ft.lbs.

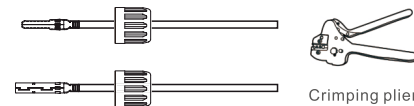

Figure 3.13 Crimp the contact pin to the wire

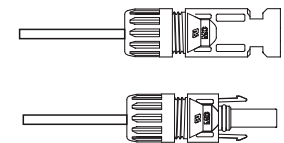

Figure 3.14 Connector with Cap nut Screwed on

3. Installation

5. Measure PV voltage of DC input with multimeter, verify DC input cable polarity (see figure 3.15), and ensure each string voltage is in range of inverter operation. Connect DC connector with inverter until hearing a slight clicking sound indicating successful connection. (see figure 3.16)



Figure 3.15 Multimeter measurement

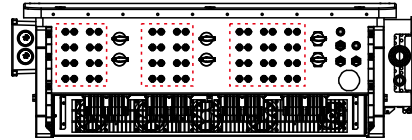

Figure 3.16 Connect the DC Connectors to the Inverter

Cable type	Traverse area (mm ²)		Outside diameter of cable (mm)
	Range	Recommended value	
Industry generic PV cable (model:PV1-F)	4.0~6.0 (12~10AWG)	4.0 (12AWG)	5.5~9.0



Caution:

If DC inputs are accidentally reversely connected or inverter is faulty or not working properly, it is NOT allowed to turn off the DC switch as it will damage the inverter and even leads to a fire disaster.

The correct actions are:

- *Use a clip-on ammeter to measure the DC string current.
 - *If it is above 0.5A, please wait for the solar irradiance reduces until the current decreases to below 0.5A.
 - *Only after the current is below 0.5A, you are allowed to turn off the DC switches and disconnect the PV strings.
- Please note that any damages due to wrong operations are not covered in the device warranty.

Requirements for the PV modules per MPPT input:

- All PV modules must be of the same type and power rating.
- All PV modules must be aligned and tilted identically.
- The open-circuit voltage of the PV array must never exceed the maximum input voltage of the inverter, even at the coldest expected temperature. (see section 10 “Specifications” for input current and voltage requirements)
- Each string connected to a single MPPT must consist of the same number of series-connected PV modules.

3. Installation

3.4.2.1 DC connection high voltage danger notice



CAUTION
RISK OF ELECTRIC SHOCK

Do not touch an energized DC conductor. There are high voltages present when PV modules are exposed to light causing a risk of death due to an electric shock from touching a DC conductor!

Only connect the DC cables from the PV module to the inverter as described in this manual.



CAUTION
POTENTIAL DAMAGE TO THE INVERTER DUE TO OVERVOLTAGE

The DC input voltage of the PV modules must not exceed the maximum rating of the inverter. (see section 10 “Specifications”)

Check the polarity and the open-circuit voltage of the PV strings before connecting the DC cables to the inverter.

Confirm proper string length and voltage range before connecting DC cable to the inverter.

3.4.3 Connect grid side of inverter



WARNING
An over-current protection device must be used between the inverter and the grid.

- 1). Connect the three (3) AC conductors to the three (3) AC terminals marked “L1”, “L2” and “L3”. Refer to local code and voltage drop tables to determine the appropriate wire size and type.
- 2). Connect the grounding conductor to the terminal marked “PE” (protective earth, the ground terminal).

Over-Current Protection Device (OCPD) for the AC side

To protect the inverter’s AC connection line, we recommend installing a device for protection against over-current and leakage, with the following characteristics noted in Table 3.2 (The OCPD shall comply with IEC/EN60947-3):



NOTE
Use AL-CU transfer (bi-metallic) terminal or anti-oxidant grease with aluminum cables and terminals.

3. Installation

3. Installation

Inverter	Rated voltage(V)	Max. output current (Amps)	Current for protection device (A)
Solis-185K-EHV-5G-US	600	178.0	250
Solis-255K-EHV-5G-US	800	184.0	250

Table 3.2 Rating of grid OCPD

3.4.3.1 Connecting the inverter to the utility grid

All electrical installations must be carried out in accordance with the local standards and the National Electrical Code® ANSI/NFPA 70 or the Canadian Electrical Code® CSA C22.1. The AC and DC electric circuits are isolated from the enclosure. If required by section 250 of the National Electrical Code®, ANSI/NFPA 70, the installer is responsible for grounding the system.

The grid voltage must be within the permissible range. The exact operating range of the inverter is specified in section 10 "Specifications".

3.4.3.2 Wiring procedure



CAUTION

RISK OF ELECTRIC SHOCK. Prior to starting the wiring procedure, ensure that the three-pole circuit breaker is switched off and cannot be reconnected.



NOTE

Damage or destruction of the inverter's electronic components due to moisture and dust intrusion will occur if the enclosure opening is enlarged.



CAUTION

Risk of fire if two conductors are connected to one terminal. If a connection of two conductors to a terminal is made, a fire can occur. NEVER CONNECT MORE THAN ONE CONDUCTOR PER TERMINAL.



NOTE

Use M10 crimp terminals to connect to the inverter AC terminals.

Cable specification		Live wire	Ground wire
Traverse cross sectional area (mm ²)	Range	70~300	35~50
	Recommended	70	50
Conduit diameter (mm)	Range	26~60	18~32
	Recommended	36	32



NOTE

Cable ampacity of ground wire should be more than half of cable ampacity of live wire.

1) Strip the end of AC cable insulating jacket about 11.8 inch then strip the end of each wire.

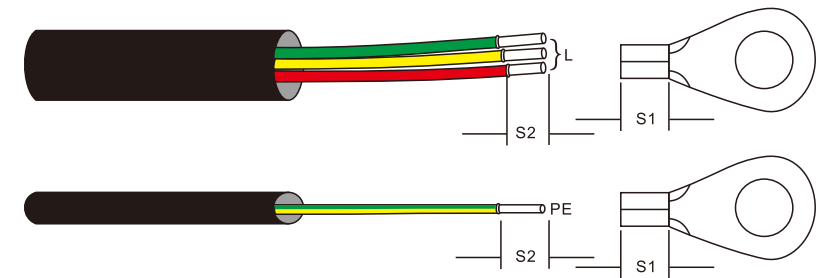

Figure 3.17 Strip AC cable



NOTE

S2 (insulation stripping length) is 2mm-3mm longer than S1. (OT cable terminal crimping area)

2) Strip the insulation of the wire past the cable crimping area of the OT terminal, then use a hydraulic crimp tool to crimp the terminal. The crimped portion of the terminal must be insulated with heat shrinkable tube or insulating tape.



NOTE:

If choosing aluminum alloy cable, you must use copper aluminum transfer terminal in order to avoid direct contact between copper bar and Aluminum alloy cable. (Please select a copper aluminum transfer terminal based on your cable specification).

3. Installation

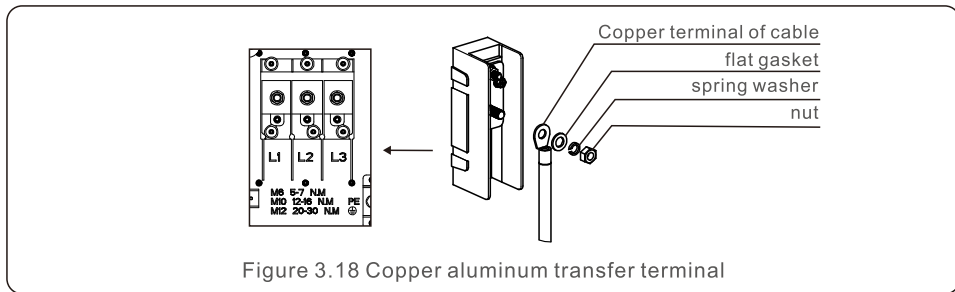

Figure 3.18 Copper aluminum transfer terminal

- 3) Leave the AC breaker disconnected to ensure it does not close unexpectedly.
- 4) Remove the 3 screws on the inverter junction box and open the junction box cover.

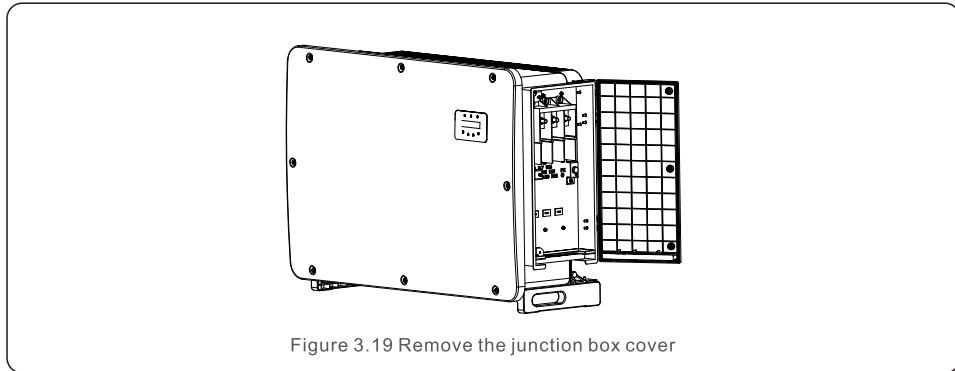

Figure 3.19 Remove the junction box cover

- 5) Insert the cable through the nut, sheath, and AC terminal cover. Connect the cable to the AC terminal block in turn, using a socket wrench. Tighten the screws on the terminal block. The torque is 7.4-14.6 ft.lbs.

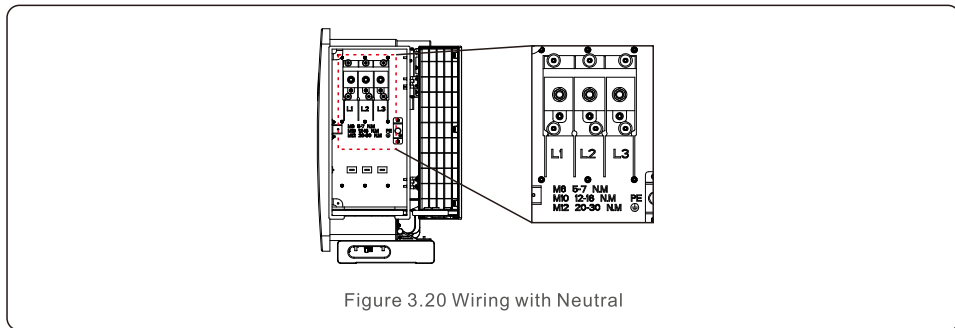

Figure 3.20 Wiring with Neutral

4. Comm. & Monitoring

4.1 RS485 and PLC communication connection

There are 5 communication terminals on the inverters. COM1 is a 4-pin connector reserved for WiFi/Cellular datalogger. COM2 and COM3 are RS485 connection between inverters and both RJ45 and Terminal block are provided for use .

Monitoring system for multiple inverters

Multiple inverters can be monitored through RS-485 daisy chain configuration.

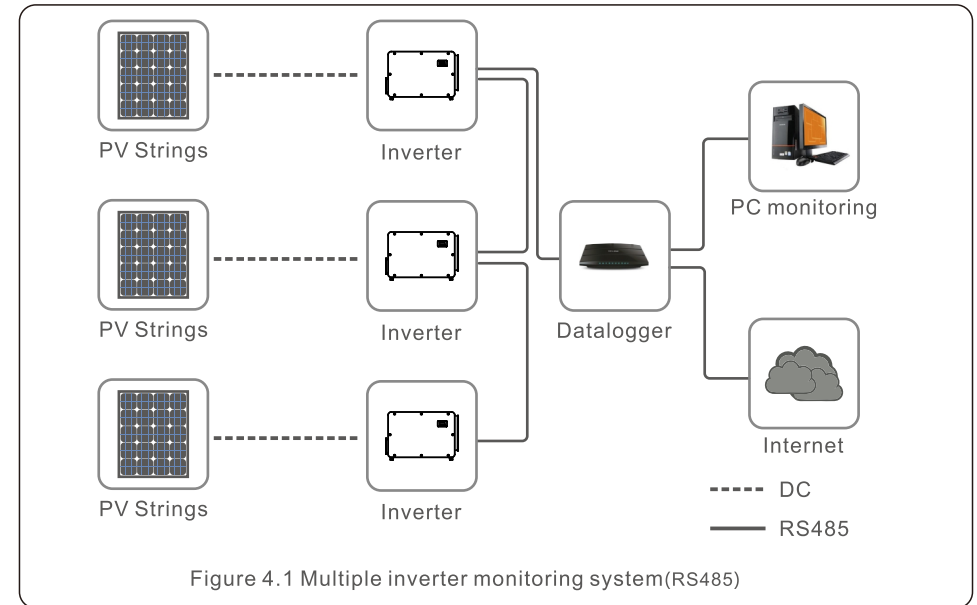

Figure 4.1 Multiple inverter monitoring system(RS485)



NOTE

One of the RS485 and PLC communication methods is available.

4. Comm. & Monitoring

PLC is available for multiple inverter monitoring.

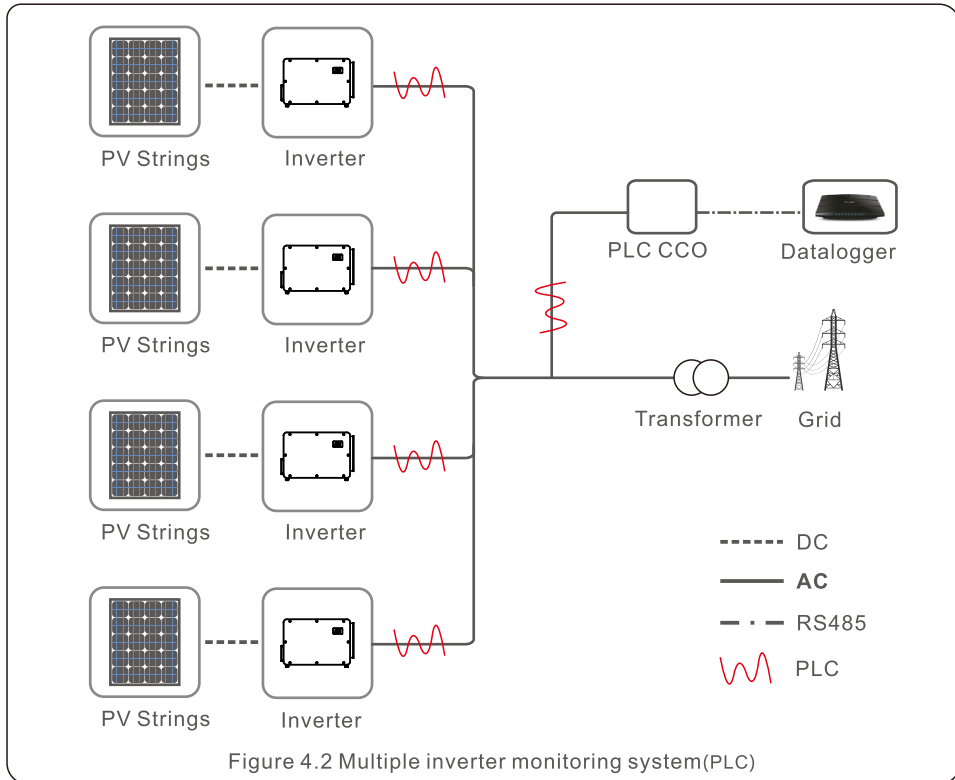

5. Commissioning

5.1 Selecting the appropriate grid standard

5.1.1 Verifying grid standard for country of installation

Solis inverters are used worldwide and feature preset standards for operating on any grid. Although the grid standard is set at the factory, it is essential the grid standard be verified for the country of installation before commissioning.

The menu for changing the grid standard or for creating a custom standard is accessible as described in Section 7.5 and below.

WARNING
 Failure to set the correct grid standard could result in improper operation of the inverter, inverter damage or the inverter not operating at all.

5.2 Changing the grid standard

5.2.1 Procedure to set the grid standard

NOTE
 This operation is for service technicians only. The inverter is customized according to the local grid standard before shipping. There should be no requirement to set the standard.

NOTE
 The "User-Def" function can only be used by the service engineer. Changing the protection level must be approved by the local utility.

- 1). From the main screen on the display, select ENTER. There are 4 sub-menu options, use the UP/DOWN arrows to highlight ADVANCED SETTINGS. Press enter to select.



Figure 5.1

- 2). The screen will show that a password is required. The default password is "0010", press the DOWN key to move cursor, press the UP key to change the highlighted digit.

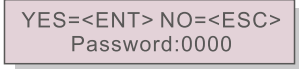

Figure 5.2

5. Commissioning

3). Use the UP/DOWN keys to highlight the SELECT STANDARD option. Press enter to select.

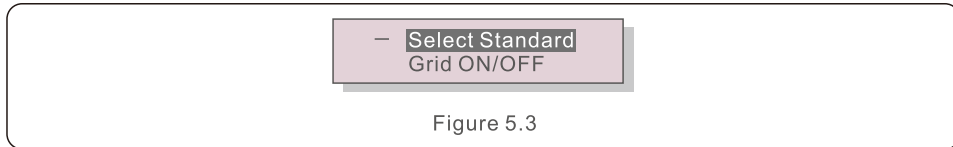

Figure 5.3

4). Select the grid standard for the country of installation.

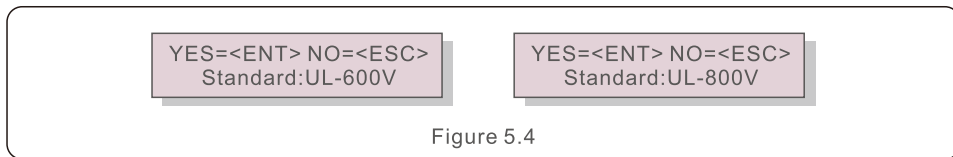

Figure 5.4

Press the UP or DOWN key to select the standard. Press the ENTER key to confirm the setting.

Press the ESC key to cancel changes and return to the previous menu.

UL-600V, R21P3-600, ISONE600 are available for 185K in U.S. and Canada.

UL-800V, R21P3-800, ISONE800 are available for 255K in U.S. and Canada.

5.3 Setting a custom grid standard



WARNING

- Failure to set the correct grid standard could result in improper operation of the inverter, inverter damage or the inverter not operating at all.
- Only certified personnel should set the grid standard.
- Only set the grid configuration that is approved by your location and national grid standards.

1). Please refer to section 6.7 “Advanced Settings” for procedures to create a custom grid configuration for User-Def menu option.

5. Commissioning

5.4 Preliminary checks



WARNING

High Voltage.

AC and DC measurements should be made only by qualified personnel.

5.4.1 DC Connections

Verify DC connections.

- 1). Lightly tug on each DC cable to ensure it is fully captured in the terminal.
- 2). Visually check for any stray strands that may not be inserted in the terminal.
- 3). Check to ensure the terminal screws are the correct torque.

5.4.2 AC Connections

Verify AC connections.

- 1). Lightly tug on each AC cable to ensure it is fully captured in the terminal.
- 2). Visually check for any stray strands that may not be inserted in the terminal.
- 3). Check to ensure the terminal screws are the correct torque.

5.4.3 DC configuration

Verify DC configuration by noting the number of panels in a string and the string voltage.

5.4.3.1 VOC and Polarity

Measure VOC, and check string polarity. Ensure both are correct and VOC is in specification.



WARNING

Input voltages higher than the maximum value accepted by the inverter (see “Specifications” in section 10) may damage the inverter. Although Solis inverters feature reverse polarity protection, prolonged connection in reverse polarity may damage these protection circuits and/or the inverter.

5.4.3.2 Leakage to ground

Measure leakage to ground to check for a DC ground fault.

5. Commissioning

5.4.3.2.1 Detection of leakage to ground

Solis inverters are transformer-less and do not have an array connection to ground. Any measurement of a fixed voltage between ground and either the positive or negative string wiring indicates a leakage (ground fault) to ground and must be corrected prior to energizing the inverter or damage to the inverter may result.

5.4.4 AC configuration

Verify AC configuration.

5.4.4.1 Measure VAC and frequency

Measure VAC and verify voltage is within local grid standards.

- 1). Measure each phase to ground (L-G).
- 2). Measure phases to the other phases in pairs (L-L). PH A to PH B, PH B to PH C and PH C to PH A.
- 3). If the meter is equipped, measure the frequency of each phase to ground.
- 4). Ensure each measurement is within local grid standards and the inverter specifications as noted in section 10 "Specifications".

5.4.4.2 Phase rotation test

A phase rotation test is recommended to ensure the phases have been connected in the appropriate order. Solis inverters do not require a specific phase rotation connection. However, the local utility may require a specific phase rotation or a record of the phase configuration of the installation.

6. Start and Shutdown

6.1 Start-up procedure

To start-up the inverter, it is mandatory that the steps below are followed in the exact order outlined.

- 1). Ensure the commissioning checks in Section 5 have been performed.
- 2). Switch the AC switch ON.
- 3). Switch the DC switch ON. If the PV array (DC) voltage is higher than the inverter's start-up voltage, the inverter will turn on. The red DC POWER LED and LCD will be continuously lit.
- 4). Solis inverters are powered from the DC side. When the inverter detects DC power that is within start-up and operating ranges, the inverter will turn on. After turn-on, the inverter will check internal parameters, sense and monitor AC voltage, hertz rate and the stability of the supply grid. During this period, the green OPERATION LED will flash and the LCD screen will show INITIALIZING. This tells the operator that the inverter is preparing to generate AC power.
- 5). After the locally mandated delay (300 seconds for IEEE-1547 compliant inverters), the inverter will start generating AC power. The green OPERATION LED will light continuously and the LCD screen will show GENERATING.



CAUTION

The inverter's surface temperature can reach up to 75°C (167° F). To avoid risk of burns, do not touch the surface when the inverter is in the operational mode. Additionally, the inverter must be installed out of the reach of children.

6.2 Shutdown procedure

To stop the inverter, it is mandatory that the steps below are followed in the exact order outlined.

- 1). Switch AC switch OFF.
- 2). Wait approximately 30 seconds (during this time, the AC side capacitors are dissipating energy). If the inverter has DC voltage above the start-up threshold, the red POWER LED will be lit. Switch the DC switch OFF.
- 3). Confirm all LED's switch OFF (~one (1) minute).



CAUTION

Although the inverter DC disconnect switch is in the OFF position and all the LED's are OFF, operators must wait 20 minutes after the DC power source has been disconnected before opening the inverter cabinet. DC side capacitors can take up to 20 minutes to dissipate all stored energy.

7. Normal operation

In normal operation, LCD screen alternatively shows inverter power and operation status (see Figure 7.1). The screen can be scrolled manually by pressing the UP/DOWN keys. Pressing the ENTER key gives access to Main Menu.

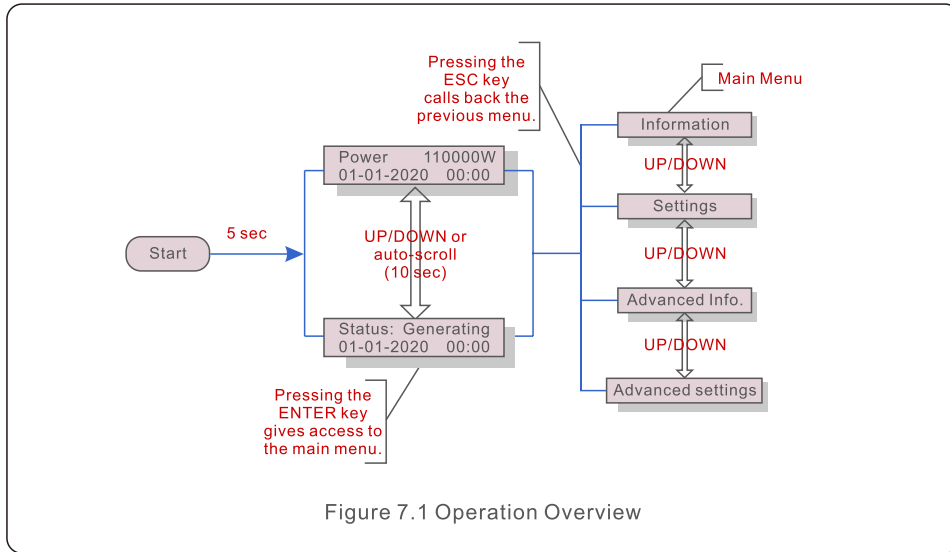

7.1 Main Menu

There are four submenus in the Main Menu (see Figure 7.1):

1. Information
2. Settings
3. Advanced Info.
4. Advanced Settings

7.2 Information

The Solis three Phase Inverter main menu provides access to operational data and information. The information is displayed by selecting "Information" from the menu and then by scrolling up or down.

7. Normal operation

Display	Duration	Description
V_AB: +000.0V I_AB: +00.0A	10 sec	V_AB: Shows output voltage between phase A and phase B. I_A: Shows output current between phase A and phase B.
V_BC: +000.0V I_B: +00.0A	10 sec	V_BC: Shows output voltage between phase B and phase C. I_B: Shows output current between phase B and phase C.
V_CA: +000.0V I_C: +00.0A	10 sec	V_CA: Shows output voltage between phase C and phase A. I_C: Shows output current between phase C and phase A.
Status: Waiting Power: 0000W	10 sec	Status: Shows instant status of the Inverter. Power: Shows instant output power value.
Rea_Power: 000000Var App_Power: 000000VA	10 sec	Rea_Power: Shows the reactive power of the inverter. App_Power: Shows the apparent power of the inverter.
Grid Frequency F_Grid 00.00Hz	10 sec	F_Grid: Shows the grid's frequency value.
Total Energy 0000000 kwh	10 sec	Total generated energy value.
This Month: 0000kwh Last Month: 0000kwh	10 sec	This Month: Total energy generated this month. Last Month: Total energy generated last month.
Today: 0000.0kwh Yesterday: 0000.0kwh	10 sec	Today: Total energy generated today. Yesterday: Total energy generated yesterday.
Inverter SN 00000000000000	10 sec	Display series number of the inverter.

Table 7.1 Information list

7. Normal operation

Display	Duration	Description
Work Mode: Volt-watt DRM NO.:08	10 sec	Work Mode: Shows current working mode. DRM NO.: Shows DRM Number.
I_DC01: +00.0A I_DC02: +00.0A ... I_DC28: +00.0A	10 sec	I_DC01 : Shows input 01 current value. I_DC02 : Shows input 02 current value. ... I_DC28 : Shows input 28 current value.
V_DC01: +0000.0A I_DC02: +00.00A ... V_DC14: +0000.0A I_DC14: +00.00A	10 sec	V_DC01 : Shows MPPT 01 current value. I_DC01 : Shows MPPT 01 current value. ... V_DC14 : Shows MPPT 14 current value. I_DC14 : Shows MPPT 14 current value.

Table 7.2 Information list

7.2.1 Lock Screen

Pressing the ESC key returns to the Main Menu. Pressing the ENTER key locks (Figure 7.2(a)) or unlocks (Figure 7.2 (b)) the screen.

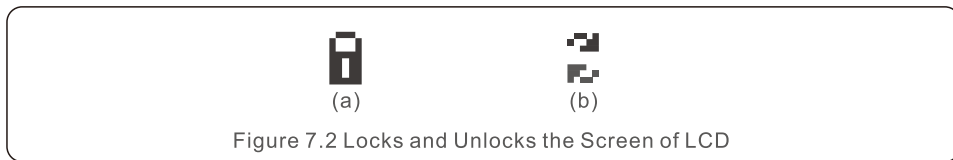

7. Normal operation

7.3 Settings

The following submenus are displayed when the Settings menu is selected:

1.Set Time

2.Set Address

7.3.1 Set Time

This function allows time and date setting. When this function is selected, the LCD will display a screen as shown in Figure 7.3.

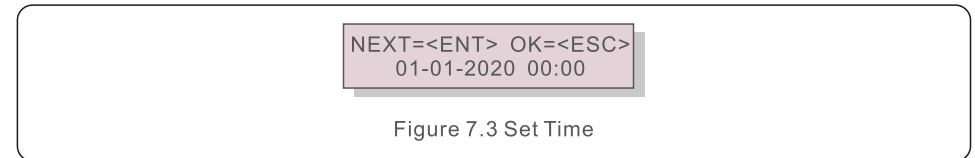

Press the UP/DOWN keys to set time and data. Press the ENTER key to move from one digit to the next (from left to right). Press the ESC key to save the settings and return to the previous menu.

7.3.2 Set Address

This function is used to set the address when muti inverters are connected to three monitor. The address number can be assigned from "01"to "99"(see Figure 7.4). The default address number of Solis Three Phase Inverter is "01".



Press the UP/DOWN keys to set the address. Press the ENTER key to save the settings. Press the ESC key to cancel the change and return to the previous menu.

7. Normal operation

7.4 Advanced Info - Technicians Only



NOTE:

To access to this area is for fully qualified and accredited technicians only. Enter menu "Advanced Info." and "Advanced settings" (need password) .

Select "Advanced Info." from the Main Menu. The screen will require the password as below:

YES=<ENT> NO=<ESC>
Password:0010

Figure 7.5 Enter password

After enter the correct password the Main Menu will display a screen and be able to access to the following information.

- 1. Alarm Message
- 2. Running message
- 3. Version
- 4. Daily Energy
- 5. Monthly Energy
- 6. Yearly Energy
- 7. Daily Records
- 8. Communication Data
- 9. Warning Message

The screen can be scrolled manually by pressing the UP/DOWN keys. Pressing the ENTER key gives access to a submenu. Press the ESC key to return to the Main Menu.

7.4.1 Alarm Message

The display shows the 100 latest alarm messages (see Figure 7.6). Screens can be scrolled manually by pressing the UP/ DOWN keys. Press the ESC key to return to the previous menu.

Alm000: OV-G-V
T: 00-00 00:00 D: 0000

Figure 7.6 Alarm Message

7.4.2 Running Message

This function is for maintenance person to get running message such as internal temperature, Standard No. 1,2,etc.

Screens can be scrolled manually by pressing the UP/DOWN keys. Press UP/DOWN key to move one date from another.

7. Normal operation

7.4.3 Version

The screen shows the model version of the inverter. And the screen will show the software ver by pressing the UP and DOWN at the same time. (see Figure 7.7).

Model: 08
Software Version: D20001

Figure 7.7 Model Version and Software Version

7.4.4 Daily Energy

The function is for checking the energy generation for selected day.

YES=<ENT> NO=<ESC>
Select: 2020-01-01

Figure 7.8 Select date for daily energy

Press DOWN key to move the cursor to day, month and year, press UP key to change the digit. Press Enter after the date is fixed.

2020-01-01: 051.3kWh
2020-01-01: 061.5kWh

Figure 7.9 Daily energy

Press UP/DOWN key to move one date from another.

7.4.5 Monthly Energy

The function is for checking the energy generation for selected month.

YES=<ENT> NO=<ESC>
Select: 2020-01

Figure 7.10 Select month for monthly energy

Press DOWN key to move the cursor to day and month, press UP key to change the digit. Press Enter after the date is fixed.

2020-01: 0000kWh
2020-02: 0000kWh

Figure 7.11 Month energy

7. Normal operation

7.4.6 Yearly Energy

The function is for checking the energy generation for selected year.

YES=<ENT> NO=<ESC>
Select: 2020

Figure 7.12 Select year for yearly energy

Press DOWN key to move the cursor to day and year, press UP key to change the digit. Press Enter after the date is fixed.

2020: 0000000kWh
2019: 0000000kWh

Figure 7.13 Yearly energy

Press UP/DOWN key to move one date from another.

7.4.7 Daily Records

The screen shows history of changing settings. Only for maintenance personnel.

7.4.8 Communication Data

The screen shows the internal data of the Inverter (see Figure 7.14), which is for service technicians only.

01-05: 01 25 E4 9D AA
06-10: C2 B5 E4 9D 55

Figure 7.14 Communication Data

7.4.9 Warning Message

The display shows the 100 latest warn messages (see Figure 7.15). Screens can be scrolled manually by pressing the UP/ DOWN keys. Press the ESC key to return to the previous menu.

Msg000:
T: 00-00 00:00 D: 0000

Figure 7.15 Warning Message

7. Normal operation

7.5 Advanced Settings - Technicians Only



NOTE:

To access to this area is for fully qualified and accredited technicians only. Please follow 7.4 to enter password to access this menu.

Select Advanced Settings from the Main Menu to access the following options:

1. Select Standard
2. Switch ON/OFF
3. Clear Energy
4. Reset Password
5. Power Control
6. Calibrate Energy
7. Special Settings
8. STD. Mode Settings
9. Restore Settings
10. HMI Update
11. Restart HMI
12. Fan Test
13. DSP Update
14. Compensation Set
17. I/V Curve

7.5.1 Selecting Standard

This function is used to select the grid's reference standard.

Selecting the "User-Def" menu will access to the following submenu.

YES=<ENT> NO=<ESC>
Standard:UL-600V

→ OV-G-V1: 660V
OV-G-V1-T: 0.6S

Figure 7.16 UL-600V

YES=<ENT> NO=<ESC>
Standard:UL-800V

→ OV-G-V1: 880V
OV-G-V1-T: 0.6S

Figure 7.17 UL-800V

Below is the setting range for "User-Def". Using this function, the limits can be changed manually. (These voltage values are the phase voltage)

7. Normal operation

Setting value	600V Rated (L-L)	600V Rated (L-N)	800V Rated (L-L)	800V Rated (L-N)
Vup-Limit1	660<V<720	381<V<415	880<V<960	508<V<553
Time1	1S	1S	1S	1S
Vup-Limit2	V≥720	V≥415	V≥960	V≥553
Time2	0.16S	0.16S	0.16S	0.16S
Vdw-Limit1	360≤V<528	207≤V<304	480≤V<704	276≤V<405
Time1	2S	2S	2S	2S
Vdw-Limit2	V<360	V<207	V<480	V<276
Time2	0.16S	0.16S	0.16S	0.16S
Fup-Limit1	60.5Hz < F < 62Hz	60.5Hz < F < 62Hz	60.5Hz < F < 62Hz	60.5Hz < F < 62Hz
Time1	2S	2S	2S	2S
Fup-Limit2	F > 62Hz	F > 62Hz	F > 62Hz	F > 62Hz
Time2	0.16S	0.16S	0.16S	0.16S
Fdw-Limit1	57Hz < F < 59.5Hz	57Hz < F < 59.5Hz	57Hz < F < 59.5Hz	57Hz < F < 59.5Hz
Time1	2S	2S	2S	2S
Fdw-Limit2	57Hz < F	57Hz < F	57Hz < F	57Hz < F
Time2	0.16S	0.16S	0.16S	0.16S

Table 7.2 Baseline Inverter Settings

OV-G-V1: 600---840V	OV-G-F1: 50.1-65Hz
OV-G-V1-T: 0.1---300S	OV-G-F1-T: 0.1---300S
OV-G-V2: 600---840V	OV-G-F2: 50.1-65Hz
OV-G-V2-T: 0.1---300S	OV-G-F2-T: 0.1---300S
UN-G-V1: 120---600V	UN-G-F1: 45.5-59.9Hz
UN-G-V1-T: 0.1---300S	UN-G-F1-T: 0.1---300S
UN-G-V2: 120---600V	UN-G-F2: 45.5-59.9Hz
UN-G-V2-T: 0.1---300S	UN-G-F2-T: 0.1---300S
Startup-T: 10-600S	Restore-T: 10-600S

Table 7.3 Setting ranges for User-Def (600V for 185K)

7. Normal operation

OV-G-V1: 700---900V	OV-G-F1: 50.1-65Hz
OV-G-V1-T: 0.1---300S	OV-G-F1-T: 0.1---300S
OV-G-V2: 700---900V	OV-G-F2: 50.1-65Hz
OV-G-V2-T: 0.1---300S	OV-G-F2-T: 0.1---300S
UN-G-V1: 500---800V	UN-G-F1: 45.5-59.9Hz
UN-G-V1-T: 0.1---300S	UN-G-F1-T: 0.1---300S
UN-G-V2: 500---800V	UN-G-F2: 45.5-59.9Hz
UN-G-V2-T: 0.1---300S	UN-G-F2-T: 0.1---300S
Startup-T: 10-600S	Restore-T: 10-600S

Table 7.4 Setting ranges for User-Def (800V for 255K)

 **NOTE**
The initial value of the User-Def standard is for reference only. It does not represent a correct value suitable for use.

7.5.2 Switch ON/OFF

7.5.2.1 Grid ON/OFF

This function is used to start up or stop the power generation of Solis Three Phase Inverter.

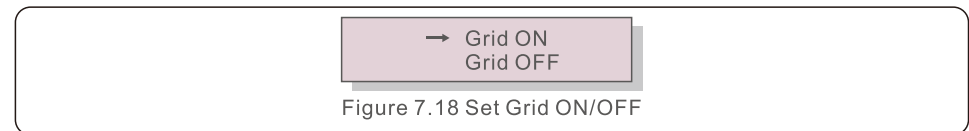

Screens can be scrolled manually by pressing the UP/DOWN keys. Press the ENTER key to save the setting. Press the ESC key to return to the previous menu.

7.5.2.2 24H-Var Switch

This function is used to disable or enable the reactive power compensation at night.

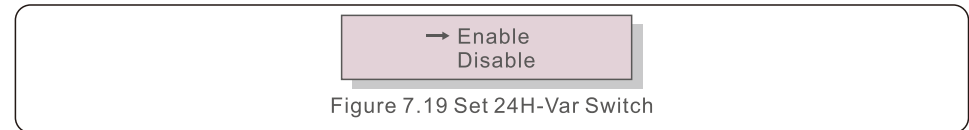

Press UP/DOWN to select and press to Enter to save the setting. Press the ESC to return to the previous menu.

7. Normal operation

7.5.3 Clear Energy

Clear Energy can reset the history yield of inverter



These two functions are applicable by maintenance personnel only, wrong operation will prevent the inverter from working properly.

7.5.4 Reset Password

This function is used to set the new password for menu "Advanced info." and "Advanced information".



```
YES=<ENT> NO=<ESC>
Password: 0000
```

Figure 7.20 Set new password

Enter the right password before set new password. Press the DOWN key to move the cursor, Press the UP key to revise the value. Press the ENTER key to execute the setting. Press the ESC key to return to the previous menu.

7.5.5 Power Control

Active and reactive power can be set through power setting button. There are 6 item for this sub menu:

1. Set Output Power
2. Set Reactive Power
3. Out_P With Restore
4. Rea_P With Restore
5. Select PF Curve
6. Max Power Choose



This function is applicable by maintenance personnel only, wrong operation will prevent the inverter from reaching maximum power.

7. Normal operation

7.5.6 Calibrate Energy

Maintenance or replacement could clear or cause a different value of total energy. Use this function could allow user to revise the value of total energy to the same value as before. If the monitoring website is used the data will be synchronous with this setting automatically.



```
YES=<ENT> NO=<ESC>
Energy:0000000kWh
```

Figure 7.21 Calibrate energy

Press the DOWN key to move the cursor, Press the UP key to revise the value. Press the ENTER key to execute the setting. Press the ESC key to return to the previous menu.

7.5.7 Special Settings



This function is applicable by maintenance personnel only, wrong operation will prevent the inverter from reaching maximum power.

7.5.8 STD Mode Settings



This section is applicable to maintenance personnel only.

Selecting "STD Mode. Settings" displays the sub-menu shown below:

1. Working Mode Set
2. Power Rate Limit
3. Freq Derate Set
4. 10mins Voltage Set
5. 3Tau Settings
6. Power Priority
7. Initial Settings
8. Voltage PCC Set

7. Normal operation

7.5.8.1 Working Mode Set

There are TWO situations with different grid standards selected.

7.5.8.1.1 With UL Standard selected

Solis US version inverters have Seven working modes:

1. NULL
2. Volt-watt
3. Volt-Var
4. Fixed-PF
5. Reac-power
6. Power-PF
7. VgWatt-UL

Based on UL1741SA, working mode 1,3,4,7 can be used by grid operator.

1.NULL

Description: Inverter is not under any working mode.

2. Volt-Watt (Not Required)

Description: Inverter will change the active output power based on voltage change.

Note: This Setting is NOT required by UL1741SA Standards.



This function is for maintenance personnel only, wrong operation will prevent the inverter from reaching maximum power.

7. Normal operation

3. Volt-Var (Default)

Description: Inverter will change the reactive output power based on voltage change.

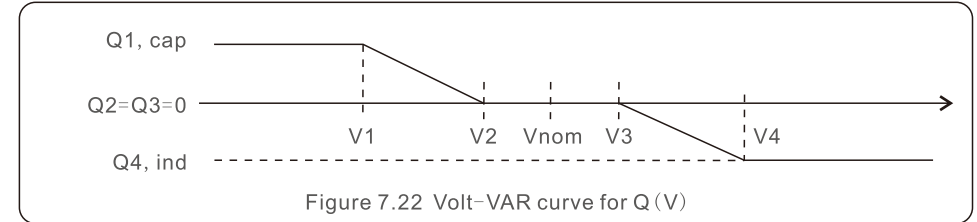

Default Settings for UL1741SA:

Q1: (0-60%) Default +30% Q4: (-60%-0%) Default -30%

Rated 600V Grid

V1:(478-599V) Default 525V V2: (478-599V) Default 589V

V3:(599-719V) Default 605V V4: (599-719V) Default 660V

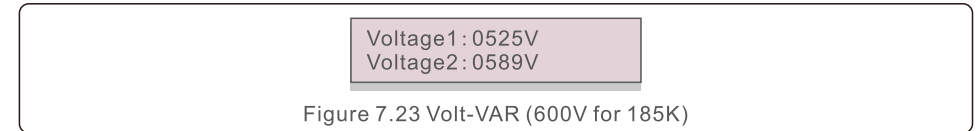

Rated 800V Grid

V1:(640-800V) Default 736V V2: (640-880V) Default 774V

V3:(800-960V) Default 826V V4: (800-960V) Default 856V

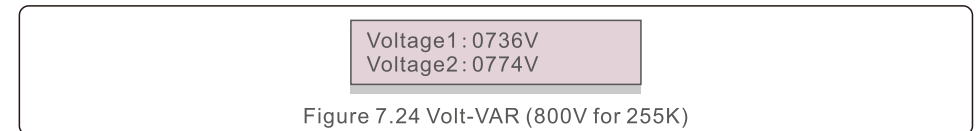

7. Normal operation

4.Fixed-PF

Description: Inverter will output power with fixed power factor.

Setting Range: -0.8 to +0.8

Default value is PF = 1

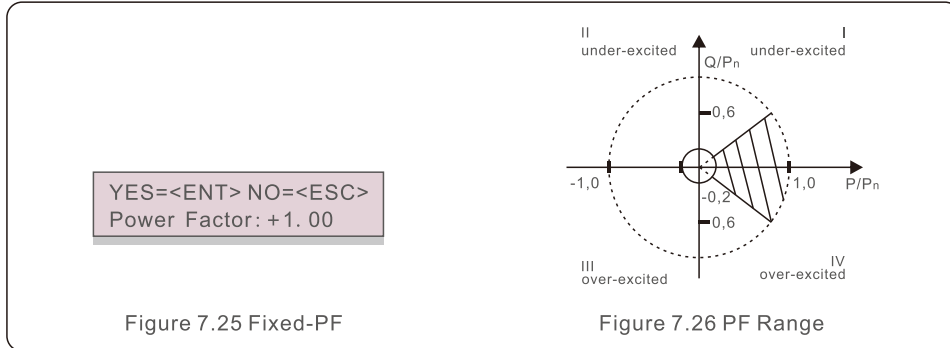

5. Reac-power (Not Required)

Description: Inverter will generate reactive power based on changing output power.

Note: This Setting is NOT required by UL1741SA Standards.

 This function is for maintenance personnel only, wrong operation will prevent the inverter from reaching maximum power.

6. P-factor (Not Required)

Description: Inverter will change power factor based on changing output power.

Note: This Setting is NOT required by UL1741SA Standards.

 This function is for maintenance personnel only, wrong operation will prevent the inverter from reaching maximum power.

7. Normal operation

7.VgWatt-UL

Description: Inverter will change the active output power based on voltage change.

Note: This is the Volt-Watt Setting for UL1741SA Standards.

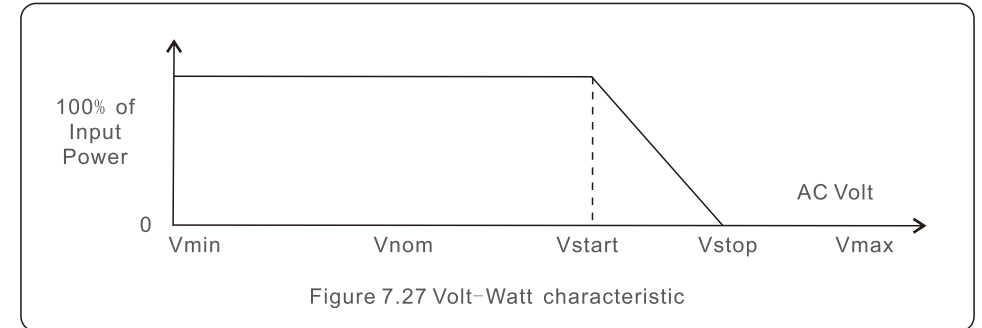

Default Settings for UL1741SA:

Rated 600V Grid

V1: less than V2

V2: less than Vstart

V3 (Vstart): (599-719V) Default 660V

V4 (Vstop): (660-779V) Default 719V

P1:100% P2:100% P3: 100% P4:0%

Voltage1 : 0550V
P-Limit1 : 100%

Figure 7.28 VgWatt-UL (600V for 185K)

Rated 800V Grid

V1:(640-800V) Default 736V V2: (800-960V) Default 848V

V3:(800-960V) Default 880V V4: (800-960V) Default 920V

P1:100% P2:100% P3: 0% P4:0%

Voltage1 : 0640V
P-Limit1 : 100%

Figure 7.29 VgWatt-UL (800V for 255K)

7. Normal operation

7.5.8.1.2 With Rule21 Standard selected

Solis US version inverters have Ten working modes:

1. NULL
2. Volt-watt
3. Volt-Var
4. Fixed-PF
5. Reac-power
6. Power-PF
7. VgWatt-UL

Based on Rule21, working mode 1,2,3,4 can be used by grid operator.



NOTE

The other three working mode "P1-V-Watt", "P1-V-Var" and "P1-V-P&V-Q" are NOT applicable for settings.

1.NULL (Mode Reset)

Description: Inverter is not under any working mode.

2. Volt-Watt

Description: Inverter will change the active output power based on voltage change.

Note: This is the Volt-Watt Setting for Rule21 Standards.

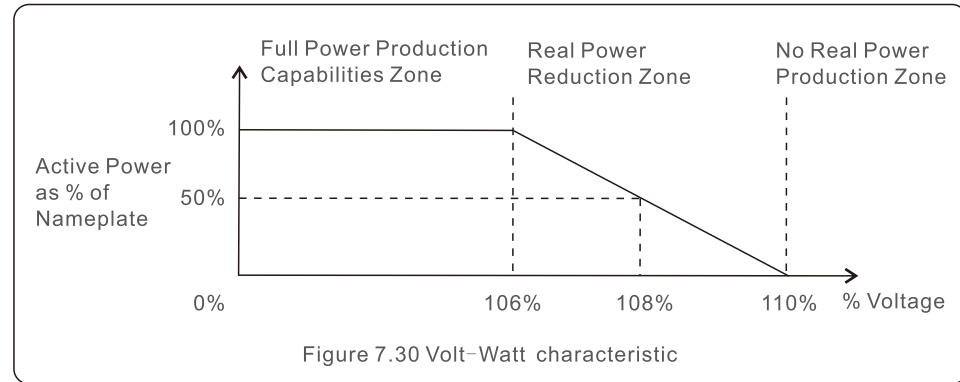

7. Normal operation

Default Settings for Rule21 Standards:

Rated 600V Grid

V1: less than Vstart

V2 (Vstart): (599-719V) Default 636V

V3 (Vstop): (660-779V) Default 660V

V4: larger than Vstop

P1:100% P2:100% P3: 0% P4:0%

Rated 800V Grid

V1:(640-800V) Default 736V V2: (800-960V) Default 848V

V3:(800-960V) Default 880V V4: (800-960V) Default 920V

P1:100% P2:100% P3: 0% P4:0%

3. Volt-Var

Description: Inverter will change the reactive output power based on voltage change.

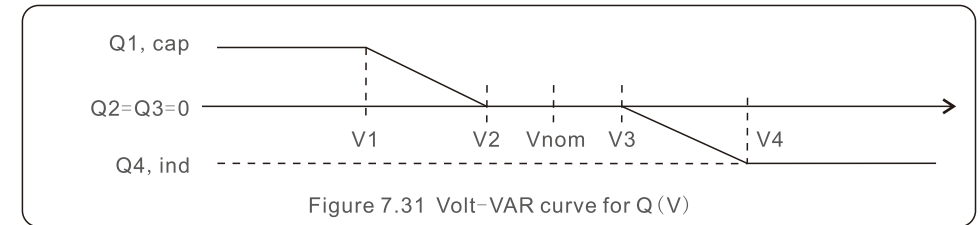

Default Settings for Rule21 Standard:

Q1: (0-60%) Default +30% Q4: (-60%-0%) Default -30%

Rated 600V Grid

V1:(478-600V) Default 551V V2: (478-600V) Default 580V

V3:(600-719V) Default 618V V4: (600-719V) Default 640V

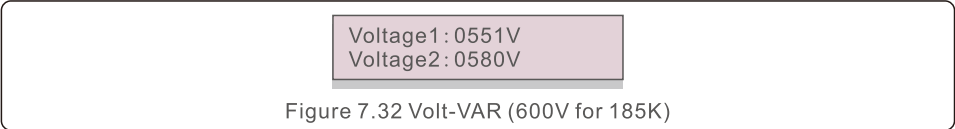

7. Normal operation

Rated 800V Grid

V1:(640-800V) Default 736V V2: (800-960V) Default 848V

V3:(800-960V) Default 880V V4: (800-960V) Default 920V

P1:100% P2:100% P3: 0% P4:0%

Voltage1 : 0796V
Voltage2 : 0880V

Figure 7.33 Volt-VAR

4.Fixed-PF

Description: Inverter will output power with fixed power factor.

Setting Range: -0.8 to +0.8

Default value is PF = 1

YES=<ENT> NO=<ESC>
Power Factor: +1.00

Figure 7.34 Fixed-PF

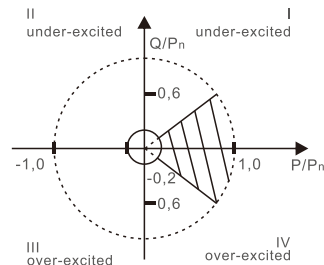

Figure 7.35 PF Range

5. Reac-power (Not Required)

Description: Inverter will generate reactive power based on changing output power.

Note: This Setting is NOT required by Rule21 Standards.



This function is for maintenance personnel only, wrong operation will prevent the inverter from reaching maximum power.

7. Normal operation

6. P-factor (Not Required)

Description: Inverter will change power factor based on changing output power.

Note: This Setting is NOT required by Rule21 Standards.



This function is for maintenance personnel only, wrong operation will prevent the inverter from reaching maximum power.

7.VgWatt-UL (Not Required)

Description: Inverter will change the active output power based on voltage change.

Note: This Setting is NOT required by Rule21 Standards.



This function is for maintenance personnel only, wrong operation will prevent the inverter from reaching maximum power.

8. Enable both Volt-Var and Volt-Watt modes

Description: Rule21 requires both Volt-var and Volt-watt modes can be enabled.

To set both modes (Volt-var in high priority)

Step 1: Select and set Volt-watt mode at first.

Step 2: Enter "Working Mode" again and select and set Volt-var mode then.

Step 3: To check the priority, a new mode will appear as "V-Q & V-P" which indicates (Q) Volt-var is in high priority.

YES=<ENT> NO=<ESC>
Work Mode : V-Q & V-P

Figure 7.36 Work Mode

7. Normal operation

To set both modes (Volt-watt in high priority)

Step 1: Select and set Volt-var mode at first.

Step 2: Enter "Working Mode" again and select and set Volt-watt mode then.

Step 3: To check the priority, a new mode will appear as "V-P & V-Q" which indicates (P) Volt-watt is in high priority.

YES=<ENT> NO=<ESC>
Work Mode : V-P & V-Q

Figure 7.37 Work Mode

To reset dual-mode or exit the dual-mode situation

Step 1: Select "Null" mode at first.

Step 2: Enter "Working Mode" again. Redo above dual-mode setting steps to reset OR set other modes to exit dual-mode situation.



NOTE

To check the Volt-watt and Volt-var priority, simply enter the working modes. V-Q&V-P indicates Volt-Var First V-P&V-Q indicates Volt-Watt First

7.5.8.2 Power Rate Limit

This function is used for change Power Ramp-up rate. When inverter start up or input string MPPT changes, inverter power ramp-up rate is limited in this menu.

The default setting is stop (disable).

The setting range from 10% to 600%, means inverter power change rate per minute.

Values are not allowed to change. If they are set, they may not conform to the UL1741SA standard.

Power Rate:016%
RateP_Sts-US:STOP

Figure 7.38 Power Rate Limit

7. Normal operation

7.5.8.3 Freq Derate Set

This setting is applicable when UL Standards are selected.

There are 5 derate modes in this menu. When operating under standard UL-1741 limits, modes 00 to 03 are disabled. Mode 04 is used for UL1741SA frequency derating setting. Mode 08 is used for RULE21 Freq-watt setting. This sets the f start and f stop point.

Mode 04 :

Derate Mode: 04
OV-F-Start: 60. 20Hz

Figure 7.39 Freq Derate Set

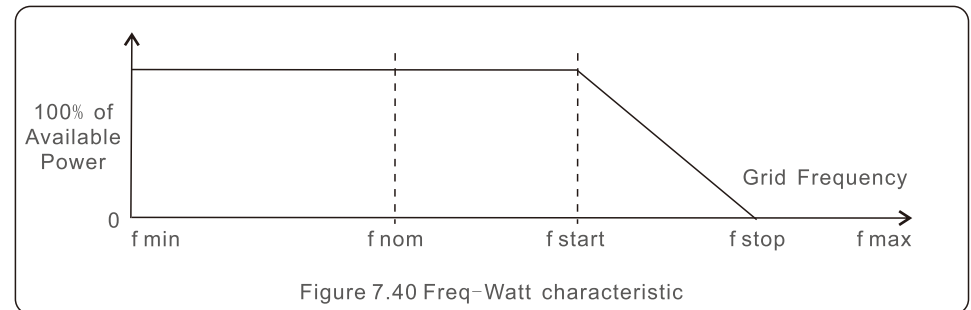

Figure 7.40 Freq-Watt characteristic

Over frequency load shedding Fstart range 60~62Hz, default setting 60.2Hz

Fstop can set the scope: 61-64Hz, the default setting 62Hz.

Press the Enter key to select the mode or frequency.

Press Up/Down to set. Press ESC to save the settings.

7. Normal operation

Mode 08 :

This setting is used to control real power based on the frequency excursion

This setting is applicable when Rule21 Standards are selected.

→ Start Freq: 60.50Hz
WGradient: 040%

Figure 7.41 Freq-Watt (1)

Start Freq: This is the frequency that active power reduction starts.

WGradient: This is the active power reduction rate in terms of the frequency.

Stop Freq: This is the frequency that stops the correction cycle.

Hysteresis: This indicates whether hysteresis is enabled.

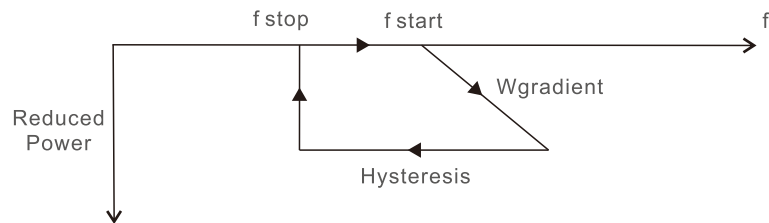

Figure 7.42 Freq-Watt (2)



This function is for maintenance personnel only, wrong operation will prevent the inverter from reaching maximum power.

7.5.8.4 10mins Voltage Set

This function is disabled and not used for the US.



This function is for maintenance personnel only, wrong operation will prevent the inverter from reaching maximum power.

7. Normal operation

7.5.8.5 Power Priority

This setting is used to set the priority between Active Power Control (Watt) and Reactive Power Control (Var).

YES=<ENT> NO=<ESC>
Select: Var First

Figure 7.43 Power Priority

Two options are available: Watt First and Var First.



This function is for maintenance personnel only, wrong operation will prevent the inverter from reaching maximum power.

7.5.8.6 Initial Settings

In initial settings it will reset each work mode from 6.5.8.1 to 6.5.8.4 back to default.

Work Mode Default
Power Rate Default

Figure 7.44 Initial Settings

6.7.8.7 Voltage PCC Set

Set the voltage at the PCC point.

This setting is required by RULE 21 requirements.

PCC: Point of Common Coupling, the point where a Local EPS is connected to an Area EPS.



This function is for maintenance personnel only, wrong operation will prevent the inverter from reaching maximum power.

7. Normal operation

7.5.9 Restore Settings

There are 5 items in initial setting submenu.

Restore setting could set all item in 7.5.7 special setting to default.

The screen shows as below:

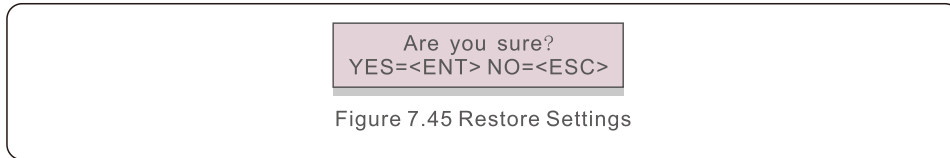
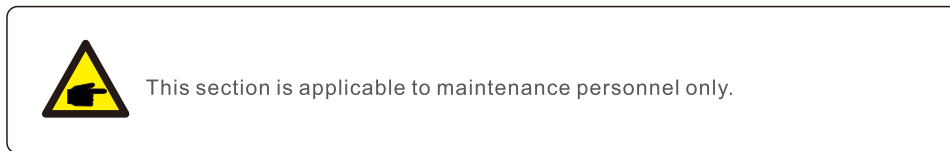

Figure 7.45 Restore Settings

Press the Enter key to save the setting after setting grid off.

Press the ESC key to return the previous mean.

7.5.10 HMI Update



Selecting “Updater” displays the sub-menu shown below:

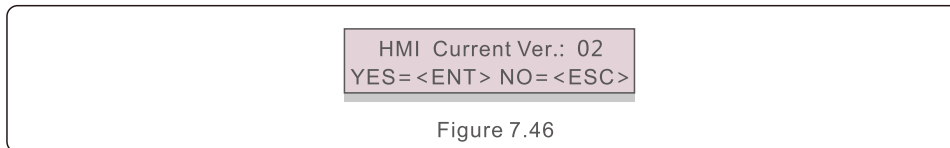

Figure 7.46

Updater is for updating LCD firmware. Press the ENTER key to start the process.

Press the ESC key to return to the previous menu.

7.5.11 Restart HMI

The function is used for restart the HMI.

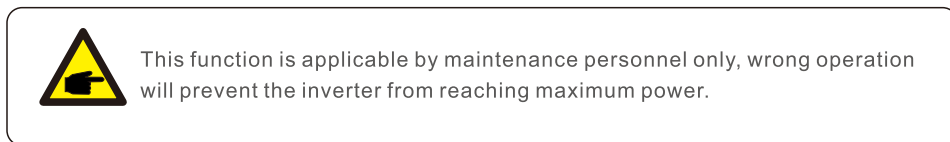

7. Normal operation

7.5.12 FAN Test

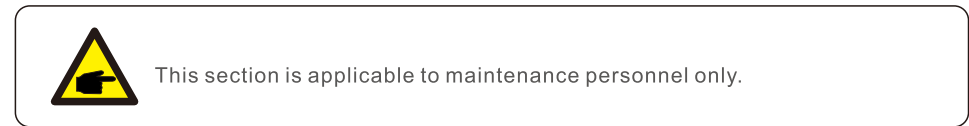

Selecting “Fan Test” displays the sub-menu shown below:

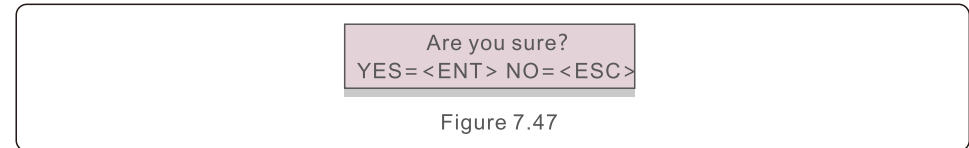

Figure 7.47

Fan Test is a factory test function. Press the ENTER key to start the test.

Press the ESC key to return to the previous menu.

7.5.13 DSP Update

The function is used for update the DSP.

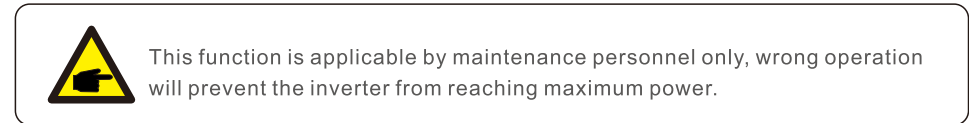

7.5.14 Compensation Set

This function is used to calibrate inverter output energy and voltage. It will not impact the energy count for inverter with RGM.

Two sections are included: Power Parameter and Voltage Parameter.

The screen shows:

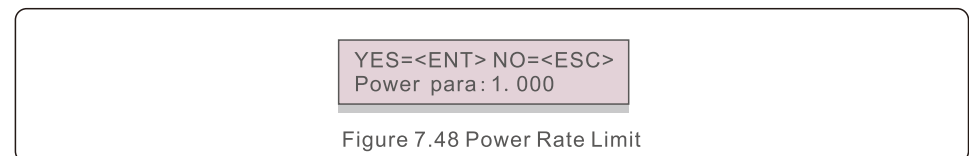
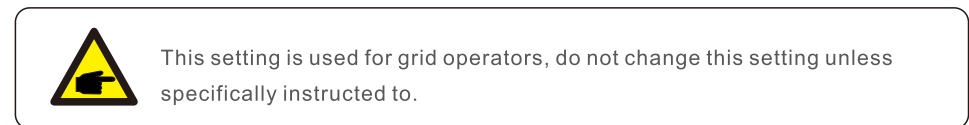

Figure 7.48 Power Rate Limit

Press the Down key to move the cursor. Press the Up key to change the digit. Please press the Enter to save the setting and press the ESC key to return to the previous menu.



7. Normal operation

7.5.15 I/V Curve

This function is used to scan the I/V characteristic curves of each PV strings.

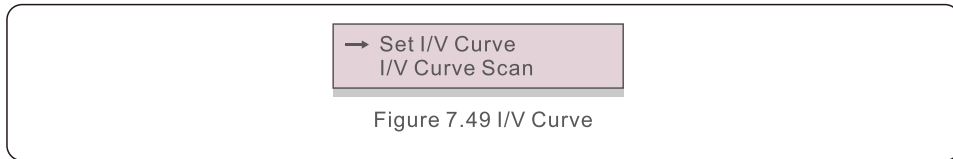

Figure 7.49 I/V Curve

7.5.15.1 Set I/V Curve

This setting can set the scanning voltage start point and the voltage interval.

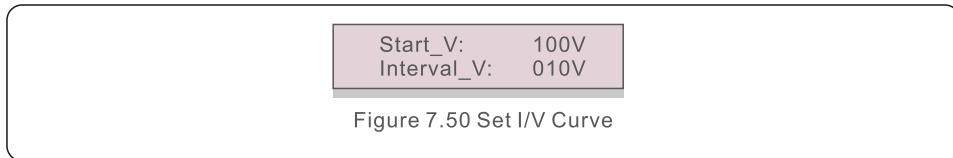

Figure 7.50 Set I/V Curve

Start_V: The start voltage of the I/V scan. (Adjustable from 100V-1400V)

Interval_V: The scanning voltage interval. (Adjustable from 001V-100V)

In total, 60 data points can be scanned.

The max scanning range is from 100-1450V.

7.5.15.2 I/V Curve Scan

Press "ENT" to start the I/V curve scan.

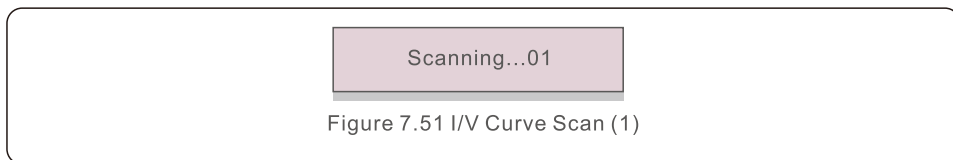

Figure 7.51 I/V Curve Scan (1)

After it is completed, the screen will display "Scan OK" and then enter the following section.

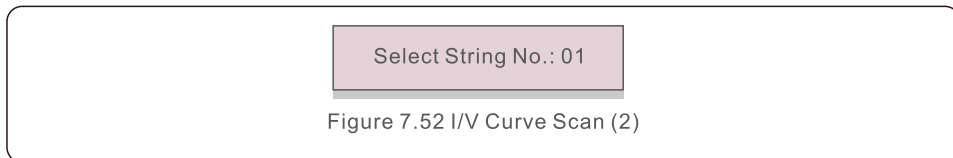

Figure 7.52 I/V Curve Scan (2)

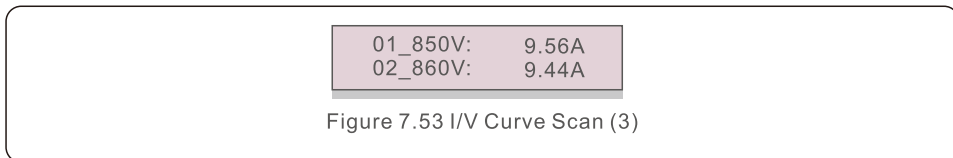
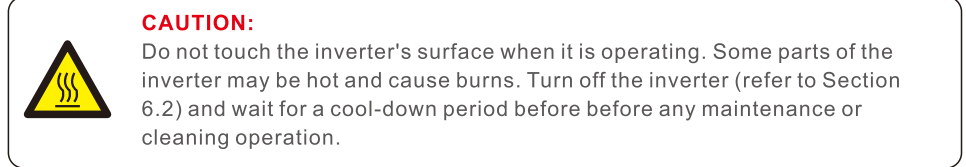

Figure 7.53 I/V Curve Scan (3)

8. Maintenance

Solis Three Phase Inverter does not require any regular maintenance. However, cleaning the dust on heat-sink will help the inverter to dissipate the heat and increase its life time. The dust can be removed with a soft brush.



The LCD and the LED status indicator lights can be cleaned with a damp cloth if they are too dirty to be read.

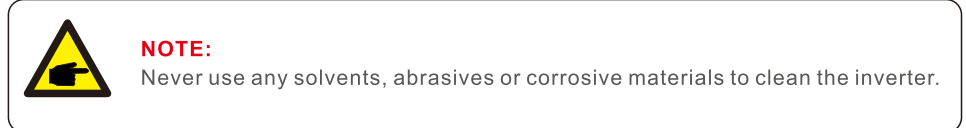

8.1 Anti-PID Function

Solis Three phase Inverters integrates optional Anti-PID module and it can recover the PID effect during night thus protect the PV system from degradation.

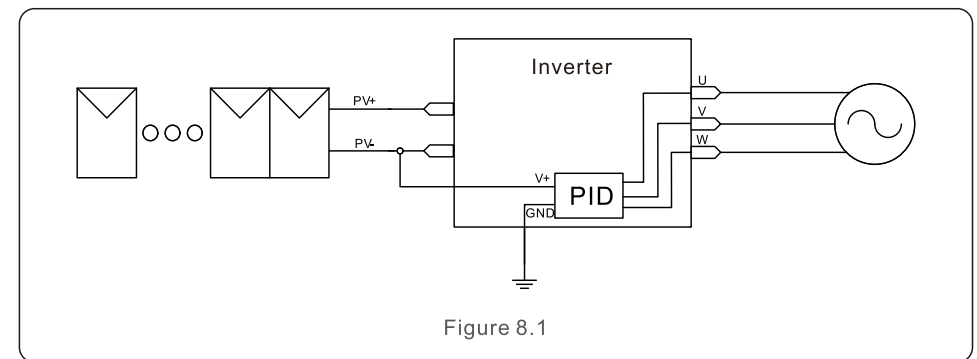
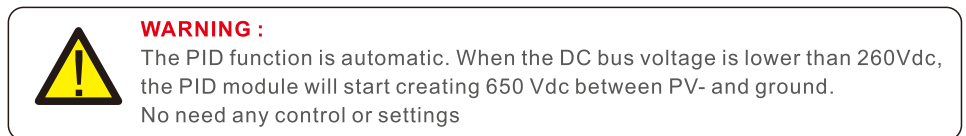

Figure 8.1

The Anti-PID module repairs the PID effect of the PV model at night. When operating, the inverter LCD screen displays "PID-repairing" information, and the red light is on. The Anti-PID function is always ON when AC is applied.

If maintenance is required and turn off the AC switch can disable the Anti-PID function.



8. Maintenance



NOTE:

If you need to maintain the inverter at night, please turn off the AC switch first, then turn off the DC switch, and wait 20 minutes before you do other operations.

8.2 Fan Maintenance

If the fan does not work properly, the inverter will not be cooled effectively, and it may affect the effective operation of the inverter.

Therefore, it is necessary to clean or replace a broken fan as follows:

1. Turn off the "Grid ON/OFF" switch on the inverter LCD.
2. Disconnect the AC power.
3. Turn the DC switch to "OFF" position.
4. Wait for 15 minutes at least.
5. Remove the 2 screws on the fan plate.
6. pull out the fan module slowly and unplug the power plug of the fan after pulling out around 150mm.
7. Clean and replace the broken fan.
8. Connect the electrical wire and reinstall the fan. Restart the inverter.

9. Troubleshooting

The inverter is designed in accordance with the most important international grid-tied standards and safety and electromagnetic compatibility requirements. Before delivering to the customer, the inverter has been subjected to several tests to ensure its optimal operation and reliability.

In case of failure, the LCD screen will display an alarm message. In this case, the inverter may stop feeding into the grid. The failure descriptions and their corresponding alarm messages are listed in Table 9.1:

Alarm Message	Failure description	Solution
No power	Inverter no power on LCD	1. Check PV input connections 2. Check if the DC input voltage higher than 620V 3. Check if PV+/- is reversed
LCD show initializing all the time	Can not start-up	1. Check if the connector on main board or power board are fixed. 2. Check if the DSP connector to power board are fixed.
OV-G-V01/02/03/04	Over grid voltage	1. Resistant of AC cable is too high. Change bigger size grid cable 2. Adjust the protection limit if it's allowed by electrical company.
UN-G-V01/02	Under grid voltage	1. Use user define function to adjust the protection limit if it's allowed by electrical company.
OV-G-F01/02	Over grid frequency	
UN-G-F01/02	Under grid frequency	
G-IMP	High grid impedance	
NO-GRID	No grid voltage	1. Check connections and grid switch. 2. Check the grid voltage inside inverter terminal.
OV-DC01/02/03/04	Over DC voltage	1. Reduce the module number in series
OV-BUS	Over DC bus voltage	1. Check inverter inductor connection 2. Check driver connection
UN-BUS01/02	Under DC bus voltage	
GRID-INTF01/02	Grid interference	1. Restart inverter 2. Change power board
OV-G-I	Over grid current	
IGBT-OV-I	Over IGBT current	
DC-INTF OV-DCA-I	DC input overcurrent	1. Restart inverter 2. Identify and remove the string to the fault MPPT 2. Change power board
IGFOL-F	Grid current tracking fail	1. Restart inverter or contact installer.
IG-AD	Grid current sampling fail	
OV-TEM	Over Temperature	1. Check inverter surrounding ventilation. 2. Check if there's sunshine direct on inverter in hot weather.

9. Troubleshooting

Alarm Message	Failure description	Solution
INI-FAULT	Initialization system fault	1.Restart inverter or contact installer.
DSP-B-FAULT	Comm. failure between main and slave DSP	
12Power-FAULT	12V power supply fault	
PV ISO-PRO 01/02	PV isolation protection	1.Remove all DC input, reconnect and restart inverter one by one. 2.Identify which string cause the fault and check the isolation of the string.
lLeak-PRO 01/02/03/04	Leakage current protection	1.Check AC and DC connection 2.Check inverter inside cable connection.
RelayChk-FAIL	Relay check fail	1.Restart inverter or contact installer.
DCinj-FAULT	High DC injection current	
AFCI self-detection (model with AFCI module)	AFCI module self-detect fault	1.Restart inverter or connect technician.
Arcing protection (model with AFCI module)	Detect arc in DC circuit	1. Check inverter connection whether arc exists and restart inverter.
Reve-DC	One of the DC string is reversely connected	1. Please check the inverters' PV string polarity, if there are strings reversely connected wait for the night when the solar irradiance is low and the PV string current down below 0.5A. Turn off the two DC switches and fix the polarity issue.
Screen OFF with DC applied	Inverter internally damaged	1.Do not turn off the DC switches as it will damage the inverter. 2.Please wait for the solar irradiance reduces and confirm the string current is less than 0.5A with a clip-on ammeter and then turn off the DC switches. 3.Please note that any damages due to wrong operations are not covered in the device warranty.

Table 9.1 Fault message and description

9. Troubleshooting



NOTE

Before grid connection, if the string has negative current, it means the voltage between the two strings of one MPPT is unbalanced. One of two string may have more PV panels than another one.



NOTE

If the inverter displays any alarm message as listed in Table 9.1; please turn off the inverter (refer to Section 6.2 to stop your inverter) and wait for 15 minutes before restarting it (refer to Section 6.1 to start your inverter). If the failure persists, please contact your local distributor or the service center. Please keep ready with you the following information before contacting us.

1. Serial number of Solis Three Phase Inverter;
2. The distributor/dealer of Solis Three Phase Inverter (if available);
3. Installation date.
4. The description of problem (i.e. the alarm message displayed on the LCD and the status of the LED status indicator lights. Other readings obtained from the Information submenu (refer to Section 6.2) will also be helpful.);
5. The PV array configuration (e.g. number of panels, capacity of panels, number of strings, etc.);
6. Your contact details.

10. Specifications

Model	Solis-185K-EHV-5G-US
Max. DC input voltage (Volts)	1500
Rated DC voltage (Volts)	950
Start-up voltage (Volts)	600
MPPT voltage range (Volts)	580...1500
Max. input current (Amps)	14*26
Max short circuit input current (Amps)	14*40
MPPT number/Max input strings number	14/28
Rated output power (Watts)	185000
Max. output power (Watts)	185000
Max. apparent output power (VA)	185000
Rated grid voltage (Volts)	3/PE~600
Rated output current (Amps)	178.0
Power Factor (at rated output power)	>0.99 (0.8 leading - 0.8 lagging)
THDi (at rated output power)	<3%(at rated output power)
Rated grid frequency (Hertz)	60
Max. efficiency	99.0%
EU efficiency	98.5%
Dimensions (W*H*D)	1070*770*384 (mm) / 46.1*30.3*15.1 (inch)
Weight	113kg / 249lb
Topology	Transformerless
Self consumption (night)	< 2W
Operating ambient temperature range	-13...140°F / -25...+60°C
Storage environment	-40...176°F / -40...+80°C
Relative humidity	0~100%
Ingress protection	Type 4X
Noise emission	≤65dB(A)
Cooling concept	Intelligent redundant cooling
Max.operation altitude	13120ft / 4000m
Compliance	UL 1741, UL 1741SA, Rule 21, UL 1998, IEEE 1547, FCC Part 15 (Class A & B), CAN/CSA C22.2 107.1-16, Rule 21 Phaes II&III
DC connection	MC4 connectors
AC connection	OT Terminal connectors (Max.300mm ²)
Display	LCD, 2x20Z
Communication connections	RS485, Optional: PLC
Warranty	5 years standard (extend to 20 years)

10. Specifications

Model	Solis-255K-EHV-5G-US
Max. DC input voltage (Volts)	1500
Rated DC voltage (Volts)	1080
Start-up voltage (Volts)	600
MPPT voltage range (Volts)	580...1500
Max. input current (Amps)	14*26
Max short circuit input current (Amps)	14*40
MPPT number/Max input strings number	14/28
Rated output power (Watts)	255000
Max. output power (Watts)	255000
Max. apparent output power (VA)	255000
Rated grid voltage (Volts)	3/PE~800
Rated output current (Amps)	184.0
Power Factor (at rated output power)	>0.99 (0.8 leading - 0.8 lagging)
THDi (at rated output power)	<3%(at rated output power)
Rated grid frequency (Hertz)	60
Max. efficiency	99.0%
EU efficiency	98.5%
Dimensions (W*H*D)	1070*770*384 (mm) / 46.1*30.3*15.1 (inch)
Weight	113kg / 249lb
Topology	Transformerless
Self consumption (night)	< 2W
Operating ambient temperature range	-13...140°F / -25...+60°C
Storage environment	-40...176°F / -40...+80°C
Relative humidity	0~100%
Ingress protection	Type 4X
Noise emission	≤65dB(A)
Cooling concept	Intelligent redundant cooling
Max.operation altitude	13120ft / 4000m
Compliance	UL 1741, UL 1741SA, Rule 21, UL 1998, IEEE 1547, FCC Part 15 (Class A & B), CAN/CSA C22.2 107.1-16, Rule 21 Phaes II&III
DC connection	MC4 connectors
AC connection	OT Terminal connectors (Max.300mm ²)
Display	LCD, 2x20Z
Communication connections	RS485, Optional: PLC
Warranty	5 years standard (extend to 20 years)

Parts	Torque
Cover screws	1.5-1.7 ft.lbs
Ground screws (Cover)	4.4-5.9 ft.lbs
Ground screws (Internal)	7.4-8.9 ft.lbs
AC terminals	7.4-14.6 ft.lbs

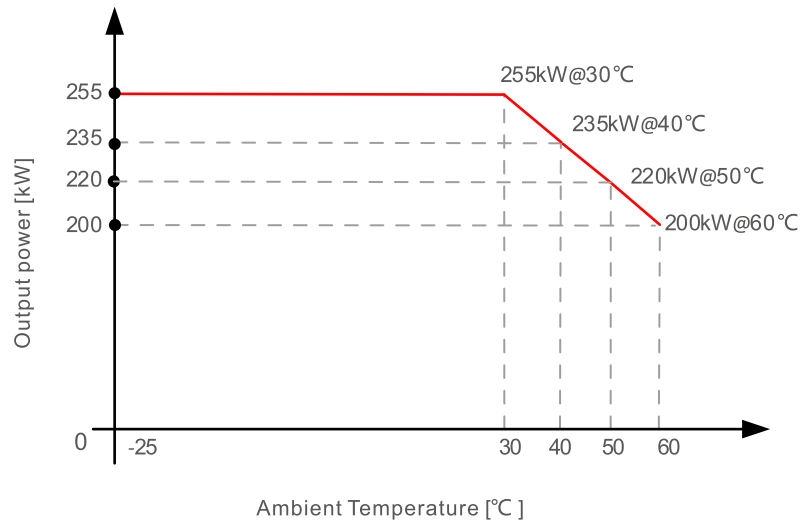

Figure 10.1 For all models of inverter

Comments:

A thermal sensor inside the inverter is calibrated to determine ambient temperature.

All inverters will begin a sloped derate at 45°C ending at 78% output power at 60°C.

Temperatures above 60°C and below -25°C will derate to 0% output power.

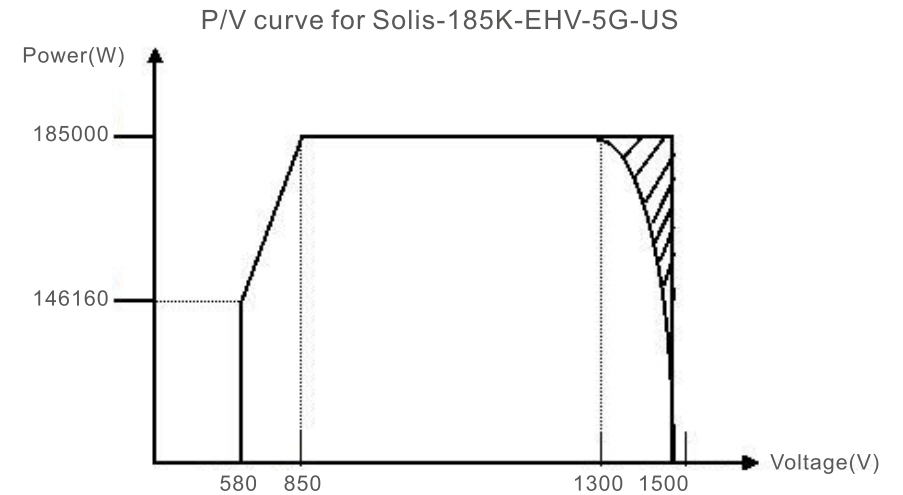

Figure 10.2 Solis-185K-EHV-5G-US Inverter output power by input voltage

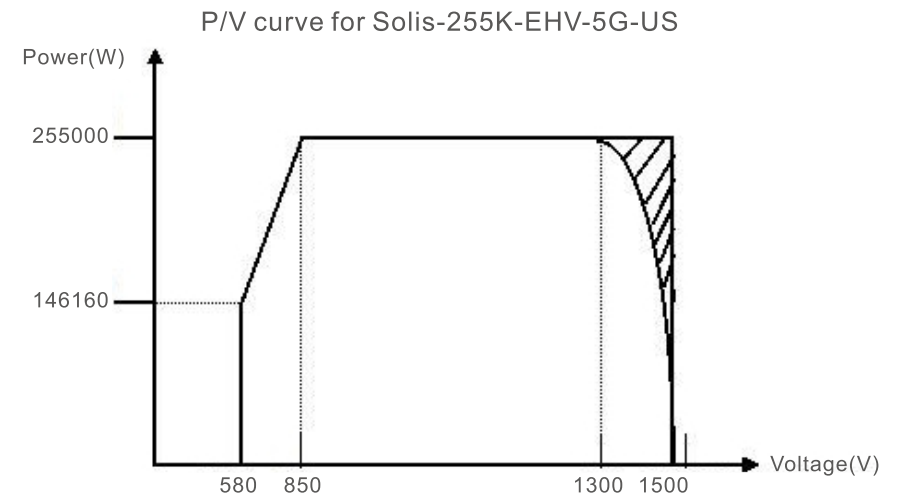

Figure 10.3 Solis-255K-EHV-5G-US Inverter output power by input voltage